

HUMAN HEALTH

ENVIRONMENTAL HEALTH



SOLUTIONS THAT
TAKE YOUR SCIENCE
IN THE RIGHT DIRECTION

2015-2016 Analytical Consumables and Supplies

Atomic Spectroscopy | Chromatography | Materials Characterization



New Investments – Local Support – Proven Quality!

For over 75 years, PerkinElmer has helped our global laboratory partners meet their most demanding application measurement challenges. Our experience in Chromatography, Spectroscopy and Materials Characterization gives us a unique advantage in providing holistic and comprehensive solutions for laboratories in universities and key market segments like Environmental, Energy, and Food & Product Safety.

When you order our precision designed, genuine PerkinElmer consumables and accessories, you can enjoy the peace of mind, ease of ordering, and best in class service. You'll get the results you need – accurately and on time. PerkinElmer selects only the highest quality products for our consumables portfolio and invests heavily to test and validate the quality of our products.

AFRICA			
Country	Telephone	Facsimile	Email
ALGERIA	+213 (0)21 91 63 73	+213 (0)21 91 63 82	info@htds.fr
ANGOLA	+27 11 564 2400	+27 11 564 2440	info.za@perkinelmer.com
BENIN	+33 1 64 86 28 28	+33 1 69 07 69 54	info@htds.fr
BOTSWANA	+27 11 564 2400	+27 11 564 2440	info.za@perkinelmer.com
BRITISH INDIAN OCEAN	+202 22905306	+202 22905307	info@htds.fr
BURKINA FASO	+33 1 64 86 28 28	+33 1 69 07 69 54	info@htds.fr
BURUNDI	+33 1 64 86 28 28	+33 1 69 07 69 54	info@htds.fr
CAMEROON	+33 1 64 86 28 28	+33 1 69 07 69 54	info@htds.fr
CAPE VERDE	+33 1 64 86 28 28	+33 1 69 07 69 54	info@htds.fr
CENTRAL AFRICA REP.	+33 1 64 86 28 28	+33 1 69 07 69 54	info@htds.fr
CHAD	+33 1 64 86 28 28	+33 1 69 07 69 54	info@htds.fr
COMOROS	+33 1 64 86 28 28	+33 1 69 07 69 54	info@htds.fr
CONGO	+33 1 64 86 28 28	+33 1 69 07 69 54	info@htds.fr
DEMO. REP. CONGO	+33 1 64 86 28 28	+33 1 69 07 69 54	info@htds.fr
DSCHIBUTI REP.	+33 1 64 86 28 28	+33 1 69 07 69 54	info@htds.fr
EGYPT	+202 22905306	+202 22905307	info@htds.fr
EQUATORIAL GUINEA	+33 1 64 86 28 28	+33 1 69 07 69 54	info@htds.fr
ERITREA	+202 22905306	+202 22905307	info@htds.fr
ETHIOPIA	+202 22905306	+202 22905307	info@htds.fr
GABON	+33 1 64 86 28 28	+33 1 69 07 69 54	info@htds.fr
GAMBIA	+33 1 64 86 28 28	+33 1 69 07 69 54	info@htds.fr
GHANA	+202 22905306	+202 22905307	info@htds.fr
GUINEA	+33 1 64 86 28 28	+33 1 69 07 69 54	info@htds.fr
GUINEA – Bissau	+33 1 64 86 28 28	+33 1 69 07 69 54	info@htds.fr
IVORY COAST	+33 1 64 86 28 28	+33 1 69 07 69 54	info@htds.fr
KENYA	+202 22905306	+202 22905307	info@htds.fr
LESOTHO	+27 11 564 2400	+27 11 564 2440	info.za@perkinelmer.com
LIBERIA	+202 22905306	+202 22905307	info@htds.fr

ORDERING INFORMATION

AFRICA			
Country	Telephone	Facsimile	Email
LIBYA	+218/92 304 48 74	+218/21 713 21 12	info@htds.fr
MADAGASCAR	+33 1 64 86 28 28	+33 1 69 07 69 54	info@htds.fr
MALAWI	+27 11 564 2400	+27 11 564 2440	info.za@perkinelmer.com
MALI	+33 1 64 86 28 28	+33 1 69 07 69 54	info@htds.fr
MAURITANIA	+33 1 64 86 28 28	+33 1 69 07 69 54	info@htds.fr
MAURITIUS	+27 11 564 2400	+27 11 564 2440	info.za@perkinelmer.com
MOROCCO	+212/(0)522 27 49 59	+212/(0)522 20 83 74	info@htds.fr
MOZAMBIQUE	+27 11 564 2400	+27 11 564 2440	info.za@perkinelmer.com
NAMIBIA	+27 11 564 2400	+27 11 564 2440	info.za@perkinelmer.com
NIGER	+33 1 64 86 28 28	+33 1 69 07 69 54	info@htds.fr
NIGERIA	+202 22905306	+202 22905307	info@htds.fr
REUNION ISLANDS	+33 1 64 86 28 28	+33 1 69 07 69 54	info@htds.fr
RWANDA	+33 1 64 86 28 28	+33 1 69 07 69 54	info@htds.fr
SENEGAL	+33 1 64 86 28 28	+33 1 69 07 69 54	info@htds.fr
SEYCHELLES	+33 1 64 86 28 28	+33 1 69 07 69 54	info@htds.fr
SIERRA LEONE	+202 22905306	+202 22905307	info@htds.fr
SOMALIA	+202 22905306	+202 22905307	info@htds.fr
REPUBLIC OF SOUTH AFRICA	+27 564 2400	+27 564 2440	info.za@perkinelmer.com
SWAZILAND	+27 11 564 2400	+27 11 564 2440	info.za@perkinelmer.com
TANZANIA	+202 22905306	+202 22905307	info@htds.fr
TOGO	+33 1 64 86 28 28	+33 1 69 07 69 54	info@htds.fr
TUNISIA	+216 70 836 961	+216 70 836 561	info@htds.fr
UGANDA	+202 22905306	+202 22905307	info@htds.fr
WESTERN SAHARA	+33 1 64 86 28 28	+33 1 69 07 69 54	info@htds.fr
ZAMBIA	+27 11 564 2400	+27 11 564 2440	info.za@perkinelmer.com
ZIMBABWE	+27 11 564 2400	+27 11 564 2440	info.za@perkinelmer.com

AMERICAS			
Country	Telephone	Facsimile	Email
ARGENTINA	54 11 4554 4004	54 11 4554 2807	
BOLIVIA	(591 2) 241 5446	(591 2) 241 0639	beco@entelnet.bo
BRAZIL	55 11 3868 6200	55 11 3868 6210	consumiveis.vendas@perkinelmer.com
CANADA	800 561 4646	905 851 1814	Orders.LSCanada@perkinelmer.com
CHILE	56 2 784 7500	56 2 236 6821	
COLUMBIA	(574) 230 57 67	(574) 230 56 04	

AMERICAS

Country	Telephone	Facsimile	Email
COSTA RICA	(506) 2 272 4700	(506) 2 272 9700	
DOMINICAN REPUBLIC	(809) 508 6500	(809) 532 0741	
ECUADOR	(593) 222 63 537	(593) 224 56 556	
EL SALVADOR	(503)2535 0700	(503)2535 0777	
GUATEMALA	(502) 25 02 47 00	(502) 25 02 47 01	
HONDURAS	(504) 2262 6700	(504) 2262 4000	
MEXICO	52 55 5337 0700	52 55 559 36223	CC.Mexico@perkinelmer.com
NICARAGUA	(505) 2 278 0177	(505) 278 0279	
PANAMA	507 3941 695	52 55 559 36223	
PARAGUAY	(598) 291 69857	(598) 291 69857	info@aldenor.com.uy
PERU	(511) 201 5800	(511) 444 9937	
PUERTO RICO	787 783 3067	787 793 7198	
TRINIDAD	(868) 671 1525	(868) 665 3703	
UNITED STATES	800 762 4000	203 944 4904	CustomerCareUS@perkinelmer.com
URUGUAY	(598) 291 69857	(598) 291 69857	info@aldenor.com.uy
VENEZUELA	58 212 7614757	58 212 7623050	

ASIA

Country	Telephone	Facsimile	Email
AFGANISTAN	+92 21 5345581	+92 21 5345582	sales@amspvtltd.com
ARMENIA	+7 495 935 8888	+7 495 564 8787	info@scheltec.ru
AUSTRALIA	61 3 9212 8500 or 1 800 033 391	61 3 9212 8595	http://go.perkinelmer.com/Consumables
AZERBAIJAN	+90 212 212 5566	+90 212 212 2829	istanbul@tetrtek.com.tr
CHINA	86 8008205046	86 2160645666	consumable.china@perkinelmer.com
GEORGIA	+7 495 935 8888	+7 495 564 8787	info@scheltec.ru
HONG KONG	852 2793 3218	852 2793 3225	info@aldenor.com.uy
INDIA	+91 22 33261700	+91 22 33261790	marketing.india@perkinelmer.com
INDONESIA	62 21 5694 5040 to 43	62 21 5694 5024	
JAPAN Kyushu	81 92 473 7001	81 92 473 8353	scalar@tsst.ent.tt
JAPAN Osaka	81 6 6386 6004	81 6 6386 7009	
JAPAN Tokyo	81 3 3866 2647	81 3 3866 2652	info@aldenor.com.uy
JAPAN Yokahama	81 45 339 5861	81 45 339 5871	
KAZAKHSTAN	+7 495 935 8888	+7 495 564 8787	info@scheltec.ru
KOREA	82 2 868 5376	82 2 868 4343	http://go.perkinelmer.com/Consumables
KYRGYZSTAN	+7 495 935 8888	+7 495 564 8787	info@scheltec.ru

ORDERING INFORMATION

ASIA			
Country	Telephone	Facsimile	Email
MALAYSIA	603 7949 1118	603 7949 1119	http://go.perkinelmer.com/Consumables
MONGOLIA	+7 495 935 8888	+7 495 564 8787	info@scheltec.ru
NEW ZEALAND	64 21 215 1198 or 0800 724 663	64 3 384 1222	http://go.perkinelmer.com/Consumables
PAKISTAN	+92 21 5345581	+92 21 5345582	sales@amspvtltd.com
PHILIPPINES	632 822 0511 to 16	632 822 0517	http://go.perkinelmer.com/Consumables
RUSSIAN FEDERATION	+7 495 935 8888	+7 495 564 8787	info@scheltec.ru
SINGAPORE	65 6868 1650	65 6872 6595	http://go.perkinelmer.com/Consumables
TAIWAN Taipei	886 2 27647199	886 2 27647209	http://go.perkinelmer.com/Consumables
TAIWAN Kaohsiung	886 7 5521030	886 7 5543402	http://go.perkinelmer.com/Consumables
TAJIKISTAN	+7 495 935 8888	+7 495 564 8787	info@scheltec.ru
THAILAND	662 319 7901	662 319 7900	http://go.perkinelmer.com/Consumables
TURKEY	+90 212 312 1100	+90 212 312 1111	cc.turkey@perkinelmer.com
TURKMENISTAN	+7 495 935 8888	+7 495 564 8787	info@scheltec.ru
VIETNAM Hanoi	84 4 3747 2258	84 4 3747 2260	http://go.perkinelmer.com/Consumables
VIETNAM Ho Chi Minh City	84 8 5431 8877	84 8 5431 8570	http://go.perkinelmer.com/Consumables
UZBEKISTAN	+7 495 935 8888	+7 495 564 8787	info@scheltec.ru

MIDDLE EAST & GULF			
Country	Telephone	Facsimile	Email
BAHRAIN	+973 17276176	+973 17275819	info@ymh.com.bh
GAZA STRIP	+202 22905306	+202 22905307	info@htds.fr
IRAQ	+202 22905306	+202 22905307	info@htds.fr
ISRAEL	1700 500512	1700 555 915	cc.israel@perkinelmer.com
JORDAN	+962(0)6 534 6523	+962(0)6 534 6527	info@htds.fr
KUWAIT	+965 22419797	+965 22419798	las@emphor.biz
LEBANON	+202 22905306	+202 22905307	info@htds.fr
OMAN	+968 248 14752	+968 248 13924	big@bigllcoman.com
PALESTINIAN TERRITORIES	+202 22905306	+202 22905307	info@htds.fr
QATAR	+974 4654563	+974 4652256	las@emphor.biz
SAUDI ARABIA	+966 11477 7932	+966 11477 1314	info@aralgosaibico.com
UNITED ARAB EMIRATES	+971 4 883 0233	+971 4 883 0133	las@emphor.biz
WEST BANK	+202 22905306	+202 22905307	info@htds.fr
YEMEN	+967 234 5073	+967 234 0504	direct@alfalahye.net

EUROPE			
Country	Telephone	Facsimile	Email
ALBANIA	0800 111 933	0800 111 934	cc.export@perkinelmer.com
AUSTRIA	0800 111 933	0800 111 934	cc.austria@perkinelmer.com
BELARUS	+7 495 935 8888	+7 495 564 8787	info@scheltec.ru
BELGIUM	0800 40858	0800 40859	cc.benelux@perkinelmer.com
BOSNIA HERZEGOVINA	+385 1 2001 767	+385 1 2001 724	hebe@hebe.hr
BULGARIA	+359 2 952 0301	+359 2 952 3784	chroma@spnet.net
CROATIA	+385 1 2001 767	+385 1 2001 724	hebe@hebe.hr
CYPRUS	+357 22 33 82 34	+357 22 33 82 32	sales@kriticos.com.cy
CZECH REPUBLIC	+420 241 430 534	+420 241 430 535	info@pesystems.cz
DENMARK	8088 4236	8088 4237	cc.nordic@perkinelmer.com
ESTONIA	+372 7 383 330	+372 7 383 360	kent@lanlab.ee
FINLAND	0800 117 186	0800 117 185	cc.nordic@perkinelmer.com
FRANCE	0805 111 333	0805 111 334	cc.france@perkinelmer.com
GERMANY	0800 181 0032	0800 181 0031	cc.germany@perkinelmer.com
GREECE	+30 2310 322525	+30 2310 321912	antisel@antisel.gr
HUNGARY	+36 1 251 1116	+36 1 251 1461	perform@perform.hu
ICELAND	+354 412 7000	+354 412 7099	medor@medor.is
IRELAND	1800 932 886	1800 932 884	cc.ie@perkinelmer.com
ISRAEL	1700 500 512	1700 555 915	cc.israel@perkinelmer.com
ITALY	+39 800 906 642	+39 02 3601 2508	cc.italy@perkinelmer.com
LATVIA	+371 6755 1894	+371 6755 1976	info@adrona.lv
LITHUANIA	+370 5 2638748	+370 5 2638749	info@linealibera.it
LUXEMBOURG	0800 26588	0800 26589	cc.benelux@perkinelmer.com
MACEDONIA	+381 11 22 22 244	+381 11 22 22 244	perkinelmer@superlab.rs
MALTA	+39 081 7013094	+39 081 7021977	info@areachem.it
MOLDAVIA	+40 21 316 2877	+40 21 316 2876	office@cromatec.ro
MONTENEGRO	+381 11 22 22 244	+381 11 22 22 244	perkinelmer@superlab.rs
NETHERLANDS	0800 0234490	0800 0234491	cc.benelux@perkinelmer.com
NORWAY	800 18 854	800 18 855	cc.nordic@perkinelmer.com
POLAND	0800 88 08 88	+48 22 310 88 01	cc.pl@perkinelmer.com
PORTUGAL	+351 21 782 60 30	+351 21 782 60 39	ilc@ilc.pt
ROMANIA	+40 21 316 2877	+40 21 316 2876	office@cromatec.ro
RUSSIAN FEDERATION	+7 495 935 8888	+7 495 564 8787	info@scheltec.ru
SERBIA	+381 11 22 22 244	+381 11 22 22 244	perkinelmer@superlab.rs

ORDERING INFORMATION

EUROPE			
Country	Telephone	Facsimile	Email
SLOVAKIA	+421 918 506782	+421 48 2301628	mla@mediclabor.sk
SLOVENIA	+386 1 427 3213/3650	+386 1 427 3191	omega@omega.si
SPAIN	800 099 164	800 099 165	atencionalcliente@perkinelmer.com
SWEDEN	0200 887 520	0200 887 521	cc.nordic@perkinelmer.com
SWITZERLAND	0800 000 015	0800 000 016	cc.switzerland@perkinelmer.com
TURKEY	+90 212 312 1100	+90 212 312 1111	cc.turkey@perkinelmer.com
UKRAINE	+7 495 935 8888	+7 495 564 8787	info@scheltec.ru
UNITED KINGDOM	0800 89 60 46	0800 89 17 14	cc.uk@perkinelmer.com

Ordering Information

Order Online

Place your order online at:

www.perkinelmer.com/shop

Online ordering is currently available in Australia, Austria, Belgium, Canada, China, Denmark, Finland, France, Germany, Ireland, Italy, Luxembourg, the Netherlands, Norway, Puerto Rico, Singapore, Spain, Sweden, Switzerland, the United Kingdom and the United States.

Order by Phone, Fax or E-mail

Please contact your local PerkinElmer Customer Care Representative. See local office listings to the left. Or visit www.perkinelmer.com/lasoffices.

Order by Mail

Visit us online at www.perkinelmer.com/lasoffices to obtain the correct address for mailing your company Purchase Order.

Return Goods Policy

Before returning any item to PerkinElmer, please obtain a Return Authorization Number from a customer service representative. Call your local PerkinElmer office and please have the following information ready:

- Our Order Number or your Purchase Order Number
- The PerkinElmer part numbers of the items that you wish to return
- Reason for return

Our customer service representative will provide you with a Return Authorization Number and the return address. We cannot accept any returns without a Return Authorization Number. Policy may vary. Please contact your local PerkinElmer representative for details.

Technical Support

For technical assistance, please contact your local PerkinElmer Customer Care Representative. See local office listings.

Check with your local PerkinElmer Customer Care center for current pricing.

PerkinElmer and the PerkinElmer logo are registered trademarks of PerkinElmer, Inc. All other product and company names mentioned herein may be the trademarks or registered trademarks of their respective owners.

PerkinElmer is not responsible for typographical or photographic errors that may appear in this catalog. We reserve the right to make adjustments or corrections due to changing market conditions, product discontinuations, or typographical or photographic errors in advertisements or product descriptions. Terms and conditions and item availability are subject to change without notice.

Terms and Conditions

For details on our terms and conditions, including warranties, please visit: www.perkinelmer.com/terms

Table of Contents

Atomic Absorption	14-33
ICP-OES	34-47
ICP-MS	48-59
Atomic Spectroscopy General	60-97
Sample Preparation	100-121
Liquid Chromatography	122-171
Gas Chromatography	172-245
FT-IR	248-267
UV/Visible	268-282
Polarimetry	283
Fluorescence	284-289
Thermal and Elemental Analysis	290-299
Part Number Index	300-331
Alphabetical Index	332-341

HUMAN HEALTH

ENVIRONMENTAL HEALTH

NOTHING
FEELS BETTER THAN
KNOWING YOU HAVE
THE BEST



PinAAcle AA Spectrometers

©2012 PerkinElmer, Inc. 400214_01. All rights reserved. PerkinElmer® is a registered trademark of PerkinElmer, Inc. All other trademarks are the property of their respective owners.

Discover the PinAAcle of Performance in AA. Engineered around cutting-edge fiber-optic technology for enhanced light throughput and superior detection limits, the new PinAAcle™ series is the latest innovation from the world leader in atomic absorption. Available in flame, furnace, or combination models, PinAAcle instruments offer exactly the level of performance you need with the smallest footprint of any combined flame/graphite furnace AA system on the market. Experience peak performance and unmatched productivity. Step up to the PinAAcle series from PerkinElmer.

www.perkinelmer.com/pinaacle

PerkinElmer®
For the Better

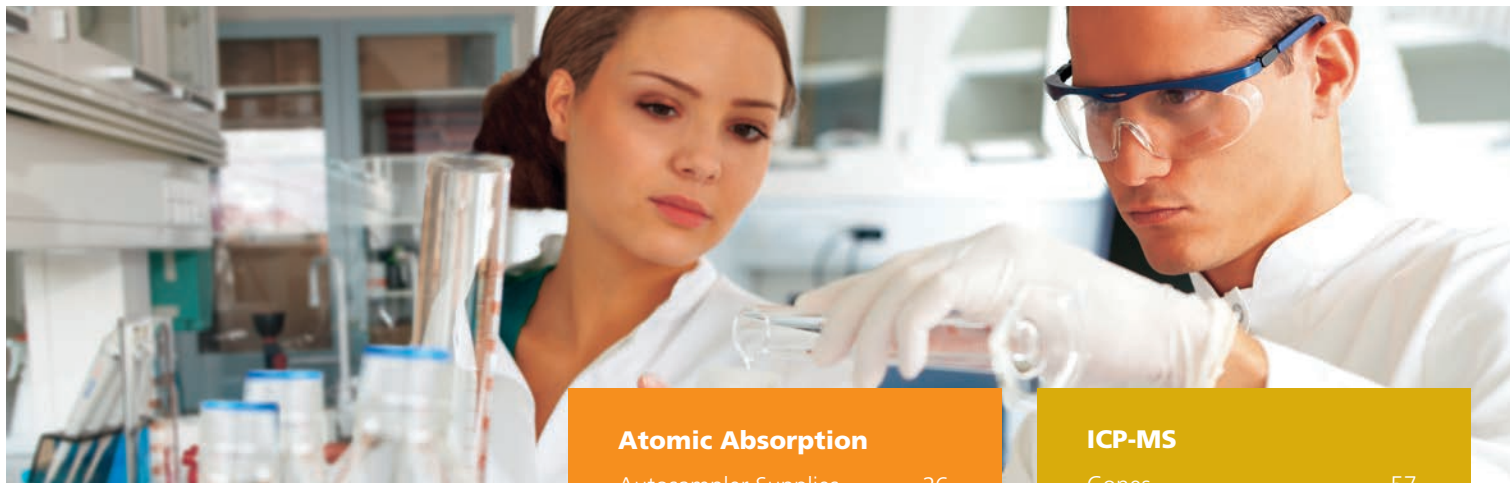

ATOMIC SPECTROSCOPY

PerkinElmer is the world leader in atomic spectroscopy solutions for atomic absorption (AA), inductively coupled plasma optical emission spectroscopy (ICP-OES) and inductively coupled plasma mass spectrometry (ICP-MS). With instruments that are the industry standard worldwide, PerkinElmer accessories, consumables, methods and application support meet the most demanding requirements and are the preferred choice in thousands of laboratories globally.

We invest heavily in testing and validating our complete portfolio of solutions to ensure that you receive accurate, repeatable results, on-time, every time throughout the lifetime of your instrument. From Lumina hollow cathode lamps that allow automatic setup and provide long lamp lifetime to our pure standards that have been analyzed and certified to yield reliable, accurate results, you'll be able to relax knowing you have the best. We also offer a complete portfolio of specialized consumables that deliver reliable performance, control operating costs and maximize the uptime of your instrument.

When you order our precision-designed, genuine Atomic Spectroscopy PerkinElmer consumables and supplies, you'll get the results you need - accurately and on time.

Atomic Absorption	
Autosampler Supplies	26
Burner System	
Components	20-21
Compressors	27
Graphite	28-32
Lamps	14-19
Mercury Analyzer Supplies	33
Nebulizers	22-25

ICP-OES	
Benches and Carts	47
Compressors	46
Injectors and Adapters	44
Load Coils and Purge Components	45
Nebulizers	34-37
Sample Introduction Kits	41
Spray Chambers	38-39
Torch Modules and Torches	40, 42-43

ICP-MS	
Cones	57
Detectors	56
Injectors and Adapters	54
Load Coils	55
Mass Spectrometer Hardware	56
Nebulizers	48-50
Sample Introduction Systems	58-59
Spray Chambers	51-53
Torches	55
Vacuum Pump Supplies	56

Atomic Spectroscopy/ General	
Autosampler Supplies	63-65
Benches and Carts	47
Cooling Systems	87
Filters and Regulators	90-91
Flow Injection Supplies (FIAS/FIMS)	66-67
Internal Standards Kits	61
Mercury Analyzer Supplies	33
Microwave Sample Preparation	95-97
Noise Enclosures	88
Power Conditioners and UPS Systems	89
Pump Tubing	60-62
Sample Preparation	92-94
Standards	68-86
Trays and Racks	64



WORLD LEADER IN AA, ICP-OES AND ICP-MS



AAnalyst 200/400 Atomic Absorption Spectrometers

Whether you choose the AAnalyst™ 200 or AAnalyst 400™, you'll discover an easy, affordable and reliable flame atomic absorption (AA) solution. We've simplified the process of AA analysis, from sample introduction to results. We've made it easy for anyone with a basic understanding of AA to get fast, reliable results every time, and we've made the quality and reliability of PerkinElmer available to everyone with these affordable systems.

Easy to use, easy to own, and featuring many of the advances that have made PerkinElmer the market leader, the AAnalyst 200 and 400 are the perfect choice for any laboratory needing a reliable, trouble-free solution for flame AA analysis.



PinAAcle 900 Atomic Absorption Spectrometers

The PinAAcle™ series of atomic absorption (AA) spectrometers brings AA performance to new heights. Engineered with an array of exciting technological advances, it offers a variety of configurations and capabilities to deliver exactly the level of performance you need:

- Flame only, furnace only, or space-saving stacked designs featuring both
- Flame, furnace, flow injection, FIAS-furnace and mercury/hydride capabilities on a single instrument
- Choice of Deuterium or longitudinal Zeeman background correction
- TubeView™ color furnace camera simplifies autosampler tip alignment and sample dispensing
- Proven Syngistix™ software offering both ease-of-use and exceptional flexibility

And no matter which model you select (900F, 900Z, 900H, 900T), you'll discover an intuitive, highly efficient system capable of simplifying your journey from sample to results – even with the most difficult matrices.

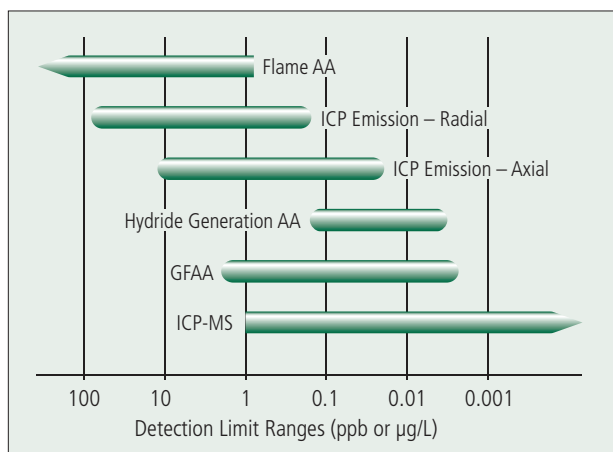

Typical detection limit ranges for the major atomic spectroscopy techniques.

PinAAcle 900 nebulizers are adjustable for optimized performance and include easily replaceable capillary assemblies and venturis for simple, reduced cost maintenance.





Optima 8x00 ICP-OES Spectrometers

With its groundbreaking features and expanded capabilities, the Optima® 8x00 series is more than just an evolution of the world's most popular ICP-OES... it's a revolution. Built around the proven design of the Optima platform, the 8x00 series delivers breakthrough performance through a series of cutting-edge technologies that optimize sample introduction, enhance plasma stability, simplify method development and dramatically reduce operating costs:

- Adjustable Torch Cassette - makes it easy to optimize performance - even with the most difficult samples and offers simple maintenance.
- Flat Plate™ Plasma Technology – with a patented, maintenance-free RF generator uses half the argon of traditional systems dramatically reducing operating costs.
- PlasmaCam™ Viewing Camera – offers continuous viewing of the plasma, simplifying method development and enabling remote diagnostic capabilities for maximum uptime.



Quick-change adjustable torch mount



NexION 350 ICP-MS Spectrometers

With a data acquisition speed 10 times faster than any other ICP-MS on the market, the NexION® 350 ICP-MS opens up a whole new world of efficiency and opportunity:

- 100,000 data points per second
- Ideal for applications that require fast transient signal analysis, such as speciation and laser ablation
- Complete characterization of nanoparticles

In addition to the exceptional application flexibility afforded by its speed, the instrument also delivers superior uptime and productivity through a variety of unique features engineered to enhance signal stability:

- Triple Cone Interface produces the industry's most tightly focused ion beam and prevents sample deposition on internal components.
- Quadrupole Ion Deflector turns positively charged ions 90° into the Universal Cell and filters off neutrals.
- Analyzing Quadrupole made of a unique steel alloy for negligible thermal expansion for unparalleled stability.
- No extraction lenses to clean for minimized maintenance.

Triple cone interface produces the most tightly focused ion beam in the industry, reducing build-up on internal components so maintenance and cleaning are minimized.



DESIGNING AND MANUFACTURING EXPERTISE



PERKINELMER HAS 40 YEARS OF EXPERTISE DESIGNING AND MANUFACTURING HOLLOW CATHODE LAMPS.

Features and Benefits

- **Long Life:** PerkinElmer's larger lamp volume results in longer lamp lifetime
- **Automation:** PerkinElmer coded lamps allow automatic setup
- **Easy Installation:** It's as simple as sliding the lamp into the instrument's lamp bracket or turret
- **Complete Compatibility:** Lumina hollow cathode lamps can be used with PerkinElmer's entire range of atomic absorption spectrometers
- **Testing:** Every lamp is thoroughly tested before leaving the factory
- **Quality:** Carefully selected materials used in the manufacturing of our lamps avoid spectral interference
- **Design:** Our design provides you with the low detection limits needed for your most difficult determinations
- **Selection:** PerkinElmer offers a wide selection of single-element and multi-element lamps
- **Easy To Order:** It's easy to find the right lamp for your analytical needs — simply use the selection charts on this page or visit our website for a complete listing
- **Warranty:** The performance of every PerkinElmer lamp is fully warranted*

Lumina Single-Element Hollow Cathode Lamps

Element Name	Element Symbol	Lumina Lamp Part No.	Lumina Lamp with Intensitron® Adapter Part No.
Aluminum	Al	N3050103	N3050303
Antimony	Sb	N3050170	N3050370
Arsenic	As	N3050105	N3050305
Barium	Ba	N3050109	N3050309
Beryllium	Be	N3050110	N3050310
Bismuth	Bi	N3050111	N3050311
Boron	B	N3050108	N3050308
Cadmium	Cd	N3050115	N3050315
Calcium	Ca	N3050114	N3050314
Chromium	Cr	N3050119	N3050319
Cobalt	Co	N3050118	N3050318
Copper	Cu	N3050121	N3050321
Dysprosium	Dy	N3050122	N3050322
Erbium	Er	N3050123	N3050323
Europium	Eu	N3050124	N3050324
Gadolinium	Gd	N3050129	N3050329
Gallium	Ga	N3050128	N3050328
Germanium	Ge	N3050130	N3050330
Gold	Au	N3050107	N3050307
Hafnium	Hf	N3050133	N3050333
Holmium	Ho	N3050135	N3050335
Indium	In	N3050137	N3050337
Iridium	Ir	N3050138	N3050338
Iron	Fe	N3050126	N3050326
Lanthanum	La	N3050141	N3050341
Lead	Pb	N3050157	N3050357
Lithium	Li	N3050142	N3050342
Magnesium	Mg	N3050144	N3050344
Manganese	Mn	N3050145	N3050345
Mercury	Hg	N3050134	N3050334
Molybdenum	Mo	N3050146	N3050346
Neodymium	Nd	N3050150	N3050350
Nickel	Ni	N3050152	N3050352
Niobium	Nb	N3050149	N3050349
Palladium	Pd	N3050158	N3050358
Phosphorus	P	N3050155	N3050355
Platinum	Pt	N3050162	N3050362
Potassium	K	N3050139	N3050339
Praseodymium	Pr	N3050161	N3050361
Rhenium	Re	N3050165	N3050365
Rhodium	Rh	N3050166	N3050366

Chart continues on next page

PERKINELMER EXCLUSIVE 6/24 WARRANTY*

Lumina™ Hollow Cathode Lamps

1. We warrant that during the first six months or after 5,000 milliampere-hours of operation, whichever comes first, from initial date of shipment, the lamps will meet or exceed the intensity and absorption specifications to which all new lamps are tested.
2. All our hollow cathode lamps are warranted to light and emit the spectra of the element indicated for two years or 5,000 milliampere-hours of operation from the date of the shipment, whichever comes first.
3. If any lamp fails before the expiration of the warranty period, it will be replaced free of charge.

*The lamp warranty is void for lamps which sustain physical damage or are operated at power levels substantially above or below the power level recommended on the lamp label. The lamp warranty may vary in different countries.



Element Name	Element Symbol	Lumina Lamp Part No.	Lumina Lamp with Intensitron® Adapter Part No.
Ruthenium	Ru	N3050168	N3050368
Samarium	Sm	N3050174	N3050374
Scandium	Sc	N3050171	N3050371
Selenium	Se	N3050172	N3050372
Silicon	Si	N3050173	N3050373
Silver	Ag	N3050102	N3050302
Sodium	Na	N3050148	N3050348
Strontium	Sr	N3050176	N3050376
Tantalum	Ta	N3050177	N3050377
Tellurium	Te	N3050180	N3050380
Terbium	Tb	N3050178	N3050378
Thallium	Tl	N3050183	N3050383
Thulium	Tm	N3050184	N3050384
Tin	Sn	N3050175	N3050375
Titanium	Ti	N3050182	N3050382
Tungsten	W	N3050187	N3050387
Vanadium	V	N3050186	N3050386
Ytterbium	Yb	N3050190	N3050390
Yttrium	Y	N3050189	N3050389
Zinc	Zn	N3050191	N3050391
Zirconium	Zr	N3050192	N3050392

Lumina Multi-Element Hollow Cathode Lamps

Element Name	Element Symbol	Lumina Lamp Part No.	Lumina Lamp with Intensitron® Adapter Part No.
Two-element Lamps			
Silver, Gold	Ag, Au	N3050201	N3050401
Calcium, Magnesium	Ca, Mg	N3050202	N3050402
Calcium, Zinc	Ca, Zn	N3050203	N3050403
Potassium, Sodium	K, Na	N3050204	N3050404
Platinum, Ruthenium	Pt, Ru	N3050205	N3050405
Tin, Tellurium	Sn, Te	N3050206	N3050406
Three-element Lamps			
Calcium, Magnesium, Zinc	Ca, Mg, Zn	N3050208	N3050408
Copper, Iron, Nickel	Cu, Fe, Ni	N3050209	N3050409
Four-element Lamps			
Copper, Iron, Manganese, Zinc	Cu, Fe, Mn, Zn	N3050212	N3050412
Five-element Lamps			
Silver, Chromium, Copper, Iron, Nickel	Ag, Cr, Cu, Fe, Ni	N3050213	N3050413
Cobalt, Chromium, Copper, Manganese, Nickel	Co, Cr, Cu, Mn, Ni	N3050214	N3050414
Six-element Lamps			
Cobalt, Chromium, Copper, Iron, Manganese, Nickel	Co, Cr, Cu, Fe, Mn, Ni	N3050217	N3050417
Seven-element Lamps			
Aluminum, Calcium, Copper, Iron, Magnesium, Silicon, Zinc	Al, Ca, Cu, Fe, Mg, Si, Zn	N3050218	N3050418

MAXIMUM INTENSITY, LONG LIFE



EDLS PROVIDE GREATER LIGHT OUTPUT AND LONGER LIFE THAN CORRESPONDING HCLS

For certain elements such as Arsenic and Selenium, EDLs will also provide improved sensitivity and lower detection limits. System 2 electrodeless discharge lamps provide the optimized spectral output needed to get the maximum performance from PerkinElmer atomic absorption spectrometers.

ELECTRODELESS DISCHARGE LAMPS FOR GREATER BRIGHTNESS

EDLs are typically much brighter and, in some cases, provide better sensitivity than comparable HCLs. EDLs are preferred for certain volatile elements. They offer better precision and lower detection limits for analyses that are “noisy” due to weak hollow cathode emission. PerkinElmer System 2 EDLs consist of the element or a salt of the element sealed in a quartz bulb containing an inert gas atmosphere. When an RF field of sufficient power is applied, the inert gas is ionized and the coupled energy vaporizes the element and excites the atoms inside the bulb, resulting in the emission of the characteristic spectrum.

PerkinElmer’s System 2 EDLs consist of a driver and a lamp sleeve. Depending on the instrument, one or two EDL lamps can be on at the same time. The driver connects to the instrument’s RF power supply (if applicable), or the external power supply if needed. The lamp sleeve contains the pre-aligned bulb for the element of interest. The sleeve has the same exterior dimensions as the PerkinElmer HCLs, allowing System 2 EDLs to be used in the same lamp mounts and turrets.

The locking pin on the lamp driver prevents operation without the lamp sleeve correctly installed on the driver.

Electrodeless Discharge Lamps are an ideal source for determining volatile elements.

Electrodeless Discharge Lamps

Element Name	Element Symbol	System 2 EDL with Coded Adapter Part No.	AAAnalyst Coded Adapter Part No.
Antimony	Sb	N3050670	N3050869
Arsenic	As	N3050605	N3050860
Bismuth	Bi	N3050611	N3050861
Cadmium	Cd	N3050615	N3050862
Cesium	Cs	N3050620	N3050863
Germanium	Ge	N3050630	N3050864
Lead	Pb	N3050657	N3050867
Mercury	Hg	N3050634	N3050865
Phosphorus	P	N3050655	N3050866
Rubidium	Rb	N3050664	N3050868
Selenium	Se	N3050672	N3050870
Tellurium	Te	N3050680	N3050872
Thallium	Tl	N3050683	N3050873
Tin	Sn	N3050675	N3050871
Zinc	Zn	N3050691	N3050874

EDL Driver Assembly required (see right page).



Features and Benefits

- **Brightness:** EDLs are much brighter and, in some cases, provide better sensitivity than comparable hollow cathode lamps
- **Precision:** EDLs offer lower detection limits and are preferred for analyses that are “noisy” due to weak hollow cathode emission
- **Long Life:** System 2 EDLs are long-lived for exceptional cost-effectiveness
- **Automation:** PerkinElmer coded lamps allow automatic set-up on systems with automated turret
- **Quality:** Carefully selected materials used in the manufacturing of our lamps avoid spectral interference
- **Testing:** Every lamp is thoroughly tested
- **Design:** Our design provides you with the low detection limits needed for your most difficult determinations
- **Warranty:** The performance of every PerkinElmer lamp is fully warranted*

EDL ASSEMBLIES AND COMPONENTS

EDL Driver Assemblies

Description	Part No.
For AAnalyst™ 200/400	N3150131
System 2 EDL driver with a short cable. For use with all instruments that have a built in EDL power supply. Adapter N3150303 is also needed if used on the AAnalyst 200/400.	03030997
Driver with a long cable. For use with the external power supply, but has the same plug connector as 03030997. Requires adapter N3150303 if used with the AAnalyst 200/400.	03030793

EDL Driver Components

Description	Part No.
Driver Assembly Adapter Cable Allows System 2 EDL Drivers (03030793 and 03030997) to be used on an AAnalyst 200/400.	N3150303
Extension cable for 03030997 if a longer length is needed.	03030998

THE PERKINELMER EXCLUSIVE WARRANTY*

System 2 Electrodeless Discharge Lamps

1. We warrant that during the first six months or after 500 hours of operation, whichever comes first, from initial date of shipment, the lamps will meet or exceed the intensity and absorption specifications to which all new lamps are tested.
2. All our Electrodeless Discharge Lamps are warranted to light and emit the spectra of the element indicated for two years or 1,000 hours of operation from the initial date of shipment, whichever comes first.
3. If any lamp fails before the expiration of the warranty period, it will be replaced free of charge.

* The lamp warranty is void for lamps that sustain physical damage or are operated at power levels substantially above or below the power level recommended on the lamp label. The lamp warranty may vary in different countries.





1.5 INCH LAMPS DESIGNED FOR NON-PERKINELMER INSTRUMENTS

ATOMAX™ 1.5" AA LAMPS FROM PERKINELMER, THE WORLD LEADER IN ATOMIC ABSORPTION

Atomax 1.5" hollow cathode lamps are crafted to the same high standards that have made PerkinElmer 2" Lumina™ hollow cathode lamps the best in the industry. Drawing on more than 40 years of HCL design and manufacturing expertise, Atomax lamps now offer laboratories around the world a dependable, top-quality lighting source, regardless of the brand of AA instruments used.

Value-Priced and Fully Compatible with 1.5" Format AA Instruments

PerkinElmer two pin non-coded Atomax lamps are designed to fit most commercially available atomic absorption instruments including Agilent®, Thermo®, Shimadzu®, GBC®, Analytic Jena®, Hitachi® and many more. Combining affordability and industry-wide compatibility allows users of other brands of AAs to benefit from PerkinElmer's proven lamp performance. Each lamp is thoroughly tested to ensure that it will stand up to the most demanding requirements. Atomax lamps represent an exceptional value, and our money-back guarantee means you can order with complete confidence.

Tested and Validated for Highest Quality Performance

All 1.5" Atomax hollow cathode lamps are thoroughly tested to ensure maximum light output and spectral purity. Comparative results show that Atomax lamps provide equal or better performance than other AA lamps in the market. Precision engineered for high sensitivity, stable light output, low noise, and long life, you can rely on Atomax lamps for the accurate results you need.

Features and Benefits

- **Experts:** Expertise designing and manufacturing quality lamps for over 40 years. A brand you can trust
- **Compatibility:** Compatible with other manufacturer's instruments — tested and approved
- **Lifetime:** Long lifetime and performance. As the world's leading AA supplier, we know how to build lamps that provide maximum light output and spectral purity for optimum performance
- **Quality:** Every lamp ships with Certificate of Quality
- **Testing:** Lamps are thoroughly tested before leaving the factory
- **Raw Materials:** Carefully selected materials used in the manufacturing of our lamps avoid spectral interference
- **Clean:** Lamps are built to stringent specifications in a state-of-the-art lamp manufacturing facility. Great quality every time
- **Design:** Our design provides you with the low detection limits needed for your most difficult determinations
- **Value:** Equivalent or better performance than your current lamp at a great price

Every Atomax lamp includes a certificate of quality, our promise of outstanding performance levels from the leader in AA.

Atomax™ Certificate of Quality

High quality equivalent lamps for all major instrument manufacturers.

- ✓ Each lamp is designed and tested to ensure optimal performance on PerkinElmer and other manufacturer's instruments.
- ✓ Rigid quality control assures that all lamps meet the same high standard for intensity, stability, and spectral purity.
- ✓ Test data for each lamp is stored and tracked by serial number allowing performance data to be retrieved on an individual basis rather than conventional batch testing.
- ✓ Carefully selected materials used in the manufacturing of our lamps avoids spectral interference.
- ✓ Every Atomax lamp has a warranty of 5,000 milliamper-hours.*

* Please refer to warranty card for full details.

Please retain for your records.

09218_03

PERKINELMER EXCLUSIVE 6/24 WARRANTY* ATOMAX™ HOLLOW CATHODE LAMPS



1. We warrant that during the first six months for 5,000 milliampere-hours of operation, whichever comes first, from initial date of shipment, the lamps will meet or exceed the intensity and absorption specifications to which all new lamps are tested.
2. All of our hollow cathode lamps are warranted to light and emit the spectra of the element indicated for two years or 5,000 milliampere hours of operation from the date of the shipment, whichever comes first.
3. If any lamp fails before the expiration of the warranty period, it will be replaced free of charge.

* The lamp warranty is void for lamps which sustain physical damage or are operated at power levels substantially above or below the power level recommended on the lamp label. The lamp warranty may vary in different countries.

Element	Symbol	Part No.
Aluminum	Al	N2025301
Antimony	Sb	N2025347
Arsenic	As	N2025302
Barium	Ba	N2025305
Beryllium	Be	N2025306
Bismuth	Bi	N2025307
Boron	B	N2025304
Cadmium	Cd	N2025309
Calcium	Ca	N2025308
Cesium	Cs	N2025312
Chromium	Cr	N2025311
Cobalt	Co	N2025310
Copper	Cu	N2025313
Dysprosium	Dy	N2025314
Erbium	Er	N2025315
Europium	Eu	N2025316
Gadolinium	Gd	N2025319
Gallium	Ga	N2025318
Germanium	Ge	N2025320
Gold	Au	N2025303
Hafnium	Hf	N2025321
Holmium	Ho	N2025323
Indium	In	N2025324

Element	Symbol	Part No.
Iridium	Ir	N2025325
Iron	Fe	N2025317
Lanthanum	La	N2025327
Lead	Pb	N2025339
Lithium	Li	N2025328
Lutetium	Lu	N2025329
Magnesium	Mg	N2025330
Manganese	Mn	N2025331
Mercury	Hg	N2025322
Molybdenum	Mo	N2025332
Neodymium	Nd	N2025335
Nickel	Ni	N2025336
Niobium	Nb	N2025334
Osmium	Os	N2025337
Palladium	Pd	N2025340
Phosphorus	P	N2025338
Platinum	Pt	N2025342
Potassium	K	N2025326
Praseodymium	Pr	N2025341
Rhenium	Re	N2025344
Ruthenium	Ru	N2025346
Rhodium	Rh	N2025345
Rubidium	Rb	N2025343

Element	Symbol	Part No.
Samarium	Sm	N2025351
Scandium	Sc	N2025348
Selenium	Se	N2025349
Silicon	Si	N2025350
Silver	Ag	N2025300
Sodium	Na	N2025333
Strontium	Sr	N2025353
Tantalum	Ta	N2025354
Terbium	Tb	N2025355
Tellurium	Te	N2025356
Thallium	Tl	N2025359
Thorium	Th	N2025357
Thulium	Tm	N2025360
Tin	Sn	N2025352
Titanium	Ti	N2025358
Tungsten	W	N2025362
Vanadium	V	N2025361
Ytterbium	Yb	N2025364
Yttrium	Y	N2025363
Zinc	Zn	N2025365
Zirconium	Zr	N2025366

Graphite for Non-PerkinElmer Instruments can be found in the graphite section.



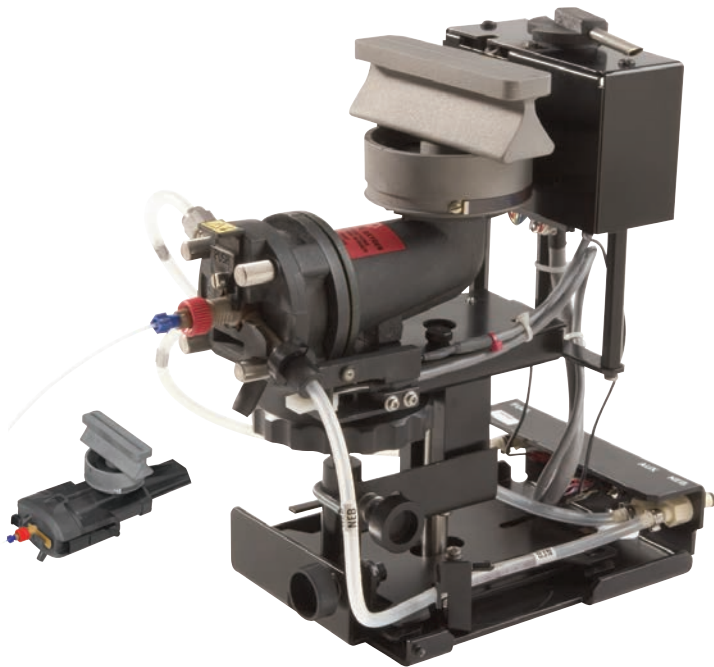

An efficient burner system is essential for obtaining optimal performance from your AA instrument, and proper maintenance is required to obtain precise and accurate determinations.

Features & Benefits

- 100% titanium burner heads, an exclusive PerkinElmer feature that provides maximum corrosion resistance when analyzing any type of sample
- Burner chambers constructed of inert, wettable plastic to allow for proper drainage of excess sample and minimize sample carryover of previous analyses
- Multivaned flow spoilers remove large sample droplets from the nebulized spray and reduce susceptibility to analytical interference
- Gaskets designed for use with aqueous and organic samples. Choose from synthetic rubber gaskets for aqueous solutions and Corkprene or KALREZ gaskets for organic solutions
- PinAAcle uses the same Burner Heads as AAnalyst series. The latest design has a hole on the rim for ease of rotation during operation. The handle is provided with the instrument

EXPERIENCE OPTIMAL EFFICIENCY

Single-slot Nitrous Oxide-acetylene 5 cm

The 5 cm nitrous oxide burner head is required for nitrous oxide-acetylene operation. This burner head can also be used with air-acetylene or rotated to provide reduced sensitivity.

Description	Part No.
Single-slot Nitrous Oxide-acetylene 5 cm	N0400100

Single-slot Air-acetylene 10 cm

The 10 cm burner head is designed to be used with the air-acetylene flame. Because of its long burner path length, it provides the best sensitivity for air-acetylene elements.

Description	Part No.
Single-slot Air-acetylene 10 cm	N0400102

Single-slot Air-acetylene 5 cm

A 5 cm air-acetylene burner head is available for applications in which reduced sensitivity is required. It can be rotated to provide further sensitivity reduction, and it has a wide slot to prevent clogging.

Description	Part No.
Single-slot Air-acetylene 5 cm	N0400101

Three-slot Air-acetylene 10 cm

The three-slot burner head is designed to be used when analyzing samples with high concentrations of dissolved solids. The three-slot burner head is not compatible with some older gas control systems.

Description	Part No.
Three-slot Air-acetylene 10 cm	N0400103



PinAAcle Burner Chamber Assembly

- A** Burner Head
- B** Burner head o-ring
- C** Spray chamber
- D** Flow spoiler
- E** End Cap Assembly
- F** Stainless Steel Nebulizer
- G** Retaining ring
- H** Burner head adjustment tool

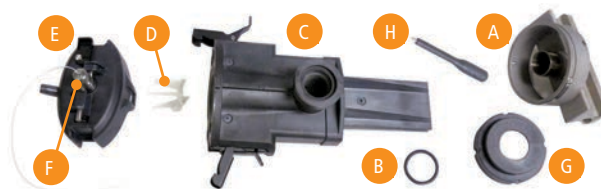

PinAAcle Burner Chamber Assembly

Burner Heads

Description	Length	Flame Type	PinAAcle 900 Part No.	AAAnalyst 100/200/300/400/700/800 Part No.
Single-slot	5 cm	Nitrous Oxide-Acetylene	N0400100	N0400100
Single-slot*	10 cm	Air-Acetylene	N0400102	N0400102
Three-slot	10 cm	Air-Acetylene	N0400103	N0400103
Single-slot	5 cm	Air-Acetylene	N0400101	N0400101
Burner Head Adjustment Tool Burner for burner heads with adjustment tool hole			N3161040	N3161040

* Standard burner head shipped with PinAAcle instrument.

Burner System Components

Description	PinAAcle 900 Part No.	AAAnalyst 100/200/300/400/700/800 Part No.
Viton Burner Head O-Ring Kit, 0.984 x 0.139 09200079 O-ring (3), 09200078 Super O-Lube (1), 09936731 (1)	09902219	09902219
Burner Mixing Chamber Assembly	N3160506	00570948
Burner Chamber Holder Assembly	N3160809	
Clamping Ring		N0401171
Flow Spoiler	00572561	00572561
End Cap O-Ring 0.312 x 0.070 (qty. 4 required)	09200253	
End Cap Viton O-Ring Standard	09902147	09902147
End Cap O-Ring Organics (Corkprene)		00472014
End Cap O-Ring Organics/Aqueous (KALREZ®)		09921044
End Cap Assembly (for use with metal body nebulizers)	N3160505	00570984
End Cap Assembly (for use with plastic body nebulizers)	N3160511	N0370392
End Cap Assembly Impact Bead (for use with metal body nebulizers)	N3160546	
Burner Gasket Kit for End Cap Assembly 00570984 00472014 (5), 09902147 (3), 09902219 (1), 09902236 (3), 09902240 (3), 09938527 (1)		00470988
Drain Tubing - Tygon Tubing with FEP lining	02507987	02507987
Seal Plug for the (00572615) Pyrex Impact Bead used with (00570984) end cap		00572624
O-Ring (1/4 in 6mm i.d.) for seal plug in the end cap 00570984		09902240
O-Ring (1/8 in 3mm i.d.) for seal plug in the end cap 00570984 and N3160545	09902236	09902236
Burner Drain Assembly for Organic Solutions	N3150232***	N3150230*
Burner Drain Assembly (includes tubing and drain interlock, drain bottle 09904991 not included)		N2011074*
Burner Drain Assembly (includes tubing and drain interlock, drain bottle 09904991 not included)	N0400058***	N0400058**
Burner Head Cleaner	03031573	03031573
Burner Head Adjustment Tool for burner heads with adjustment tool hole	N3161240	N3161240
Wide Mouth 15L Natural Bottle	09904991	09904991
10L Wide Mouth Bottle for Organics	09200122	09200122

*For AAAnalyst 700/800 **For AAAnalyst 200/400 ***For AAAnalyst 100/200/300/400

AAAnalyst Burner System Components

- A** Burner Head
- B** Burner Mixing Chamber
- C** Clamping Ring
- D** Flow Spoiler
- E** End Cap O-Ring
- F** End Cap Assembly

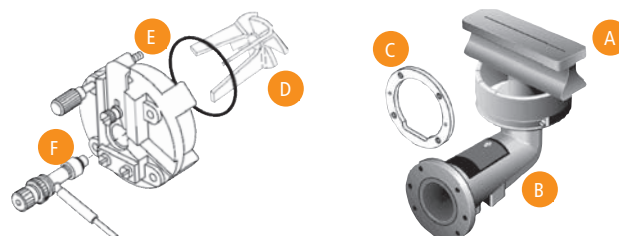

AAAnalyst Burner System Components

WIDE VARIETY OF HIGH PERFORMANCE NEBULIZERS



PinAAcle 900 Removable Burner Assembly allows switching between analytical techniques in a matter of seconds on flame/furnace combination instruments

High-Sensitivity Nebulizer with Pt/Ir Capillary

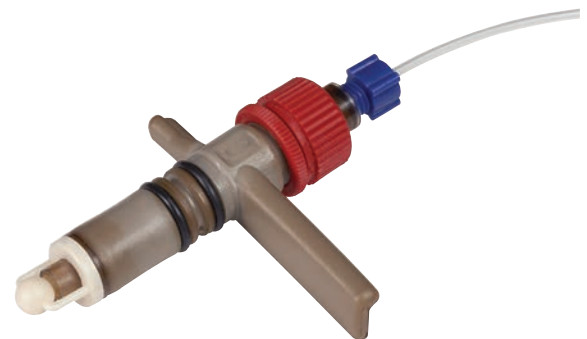

PinAAcle High-Sensitivity Nebulizer Part No. N3160144

THE NEBULIZER IS ONE OF THE MOST IMPORTANT COMPONENTS IN A FLAME AA SPECTROMETER

Sample solutions, with differing physical properties, must be converted into an aerosol of small, similarly-sized droplets. This places great demands on the design of the nebulizer.

All PerkinElmer nebulizer assemblies are adjustable for optimized performance and include easily-interchanged capillary assemblies for simple, reduced-cost maintenance. PerkinElmer nebulizers are manufactured to exacting tolerances to provide maximum sensitivity. Universal, or, "standard" nebulizers are less expensive than the corresponding high-sensitivity nebulizers and provide a lower level of sensitivity. The universal, or, "standard" nebulizers typically provide better precision and reduced "carryover" interference when used with solutions that contain high dissolved solids content of higher analyte concentrations.

HIGH-SENSITIVITY NEBULIZER WITH PT/IR CAPILLARY

Our high-precision nebulizer maximizes stability and sensitivity, even for the toughest matrices. The nebulizer is adjustable so a wide variety of sample matrices — aqueous or organic, acidic or basic, diluted or concentrated — can be analyzed under optimum conditions. This high-sensitivity nebulizer is fabricated with inert plastic materials for maximum performance and corrosion resistance.



High-Sensitivity Nebulizer

- Provides maximum sensitivity, precision and freedom from analytical interferences
- The high-sensitivity nebulizer with platinum/iridium capillary is for most solutions, but not for precious metal samples containing aqua regia
- High-sensitivity nebulizer with tantalum capillary used for solutions containing aqua regia



Metal Body Corrosion-Resistant Nebulizers

- For all solutions containing hydrofluoric acid or aqua regia
- For all solutions containing high concentrations of dissolved solids
- All internal components in contact with solutions are constructed of plastic to resist corrosion from concentrated acids
- Reduced performance compared with stainless steel or platinum/rhodium nebulizers



Metal Body Platinum Alloy Nebulizers

- Recommended for most concentrated acids containing >5% acid
- Includes a platinum alloy needle assembly and a tantalum venturi
- Provides maximum chemical resistance
- Not suitable for use with aqua regia or hydrofluoric acid



Plastic Body GemTip™ Nebulizers

- Corrosion-resistant and can be used to aspirate almost all solutions, even those solutions containing a high percentage of acids
- Designed to obtain optimum sensitivity, detection limits and precision with flame atomic absorption for both air-acetylene and nitrous oxide-acetylene flames



Metal Body Stainless Steel Nebulizers

- For most solutions containing <5% acid, providing exceptional performance and durability
- Excellent performance (precision and signal-to-noise ratio)



NEBULIZER ASSEMBLIES AND SPARES

Plastic Body Nebulizers



Description	PinAAcle 900 Part No.	AAAnalyst 200/400 Part No.	AAAnalyst 100/300/700/800 Part No.
High-Sensitivity Nebulizer with Pt/Ir Capillary			
Nebulizer Assembly	N3160144	N3150188*	B0505480**
Flame Burner Assembly (includes N3160144)	N3160179		
Impact Bead	B0505086	B0505086	B0505086
O-Ring	09902015	09902015	B0190672
O-Ring	09926126	09926126	B0506143
O-Ring 9.25 X 1.78			B0174378
Needle Assembly	B3150525	B3150525	B0505983
Spring	09920483	09920483	B0165332
End Cap	N3160511	N0370392	N0370392
Spacer	B3150531	B3150531	
Sample Tube	B3150458	B3150458	09908265
High-Sensitivity Nebulizer with Tantalum Capillary			
Nebulizer Assembly			B0505590
Impact Bead			B0505086
O-Ring 1.78 X 1.02			B0190672
O-Ring 4.47 X 1.78			B0506143
O-Ring 9.25 X 1.78			B0174378
Spring			B0165332
End Cap			N0370392
GemTip™ Nebulizers			
GemTip Nebulizer Assembly			N0370394
High-Sensitivity Nebulizer Assembly			N0370393
Impact Bead			B0505086
Spring			09902473
End Cap			N0370392

*May also be used with AAAnalyst 100/300/700/800
 **May also be used with AAAnalyst 200/400



Metal Body Nebulizers

Description	PinAAcle 900 Part No.	AAAnalyst 200/400 Part No.	AAAnalyst 100/300/700/800 Part No.
Stainless Steel Nebulizer			
Nebulizer Assembly (Aqueous)	N3160143	03030352	03030352
Nebulizer Assembly (Organics)	N3160158		
Flame Burner Assembly (includes N3160143)	N3160182		
Impact Bead	00572615	00572615	00572615
Capillary Assembly	03030354	03030354	03030354
O-Ring Kit (Includes O-Rings in Neb Assembly)		N9300065	N9300065
O-Ring 0.176 ID x 0.070 WD	09902005	09902005	09902005
O-Ring 0.364 ID x 0.070 WD	09902015		
O-Ring 0.208 ID x 0.070 WD	09902239	09902239	09902239
Spring	03031806	03031806	03031806
End Cap	N3160505	00570984	00570984
Corrosion-Resistant Nebulizer			
Nebulizer Assembly		03030404	03030404
Capillary Assembly		03030402	03030402
O-Ring Kit (Includes O-Rings in Neb Assembly)		N9300065	N9300065
Spring		03031806	03031806
End Cap		00570984	00570984
Platinum Alloy Nebulizer			
Nebulizer Assembly		03030299	03030299
Capillary Assembly		03030433	03030433
O-Ring Kit (Includes O-Rings in Neb Assembly)		N9300065	N9300065
Spring		03031806	03031806
End Cap		00570984	00570984



O-Rings for Sampling Accessories

Description	Kalrez material Organic/Aqueous Part No.	Non-Kalrez material Aqueous Only Part No.
Nebulizer, End Cap, and Burner Head O-Ring Kit for Plastic Nebulizer for PinAAcle AA. Include: 09200369 (2), 09200276 (2), 09200272 (1)	N3160157	
Nebulizer, End Cap, and Burner Head O-Ring Kit for Stainless Steel Nebulizer for PinAAcle AA. Includes: 09200271 (1), 09200273 (2), 09200274 (1), 09200276 (2)	N3160156	
Nebulizer O-Ring Kit for Stainless Steel Nebulizer for PinAAcle AA. Includes: 09200271 (1), 09200273 (2), 09200274 (1), 09200276 (2)	N3160192	
Nebulizer O-Ring Kit, Stainless Steel: 09200271 (1), 09200273 (2), 09200274 (1)	N2010247	N2010247
Nebulizer O-Ring Kit for Plastic Nebulizer for PinAAcle AA. Includes: 09200369 (2), 09200276 (2), 09200272 (1)	N3160193	
Nebulizer O-ring Kit for AA200/400. Includes: 09200369 (2), 09200340 (1), 09200276 (2), 09200272 (1)	N2010246	
End Cap O-Ring Kit for PinAAcle AA. Includes: 09200275 (4), 09200277 (1)	N3160194	
End Cap Accessory, O-Ring Kit: 09200277 (1), 09200341 (2), 09200342 (2)	N2010245	N2010245
Metal Body Nebulizer Assembly for PinAAcle (Organics)	N3160158	N3160143
High Sensitivity Plastic Nebulizer Assembly for PinAAcle (Organics)	N3160159	N3160144
O-Ring (2) 9.25 X 1.78 MM for (Metal Body/Plastic) Nebulizer Assembly	09200276	09902015
O-Ring (1) 1.80 X 1.00 MM for Metal Body Nebulizer for PinAAcle AA	09200271	09926083 & 09902102
O-Ring (1) 2.00 X 1.00 MM for High sensitivity Plastic Nebulizer Assembly	09200272	09926127
O-Ring (2) 4.47 X 1.78 MM for Metal Body Nebulizer for PinAAcle AA	09200273	09902005
O-Ring (1) 5.28 X 1.78 MM for Metal Body Nebulizer for PinAAcle AA	09200274	09902239
O-Rings (4) 7.65 X 1.78 MM for End Cap Assembly for PinAAcle AA	09200275	09200253
O-Ring (1) 47.29 X 2.62 MM for End Cap Assembly for PinAAcle AA	09200277	09902147
Burner Head O-Ring (1) 24.99 X 3.53 MM for PinAAcle/AAAnalyst AA	09200278	09200079
O-Rings 1.42 x 1.52 mm for High Sensitivity Plastic Nebulizer (Capillary kit) 1.42 x 1.52 mm	09200369	
O-Ring Viton 4.47 X 1.78 MM for Burner Connector		09200360



PinAAcle Nebulizers and Assemblies Quick Reference

Description	Type	Needle	O-Ring Type	Complete Assembly	End Cap Assembly	Replacement Needle Assembly
Plastic High Sensitivity (standard)	Aqueous	Platinum/Iridium	Viton	N3160144	N3160511	B3150525
Plastic High Sensitivity	Aqueous or Organics	Platinum/Iridium	Kalrez	N3160159	N3160189	N3160154
Plastic High Sensitivity (suitable for aqua regia in addition to organics)	Aqueous or Organics	Tantalum	Kalrez	N3160152	N3160189	N3160146
Stainless Steel (standard)	Aqueous	Stainless	Viton	N3160143	N3160505	03030354
Stainless Steel	Aqueous or Organics	Stainless	Kalrez	N3160158	N3160188	N3160153
Stainless Steel	Aqueous	Plastic	Viton		N3160505	03030402
Stainless Steel	Aqueous	Platinum Alloy	Viton		N3160505	03030133
Description	Type			Burner Drain Assembly	Drain Bottle	
Drain Assembly	Aqueous			N0400058	09904991	
Drain Assembly	Organics			N3150232	09200122	

AA200/400 Nebulizers and Assemblies Quick Reference

Description	Type	Needle	O-Ring Type	Complete Assembly	End Cap Assembly	Replacement Needle Assembly
Plastic High Sensitivity (suitable for aqua regia in addition to organics)	Aqueous or Organics	Tantalum	Kalrez	N2010250		N3160146
Nebulizer, Plastic	Aqueous or Organics	Tantalum	Kalrez	N2010250	N2010245	N3160146

Nebulizer Accessories

Description	Part No.
Capillary Tubing	09908265
Nebulizer Cleaning Wires Pkg. 5	03030135
Nebulizer Grease	03030405



Nebulizer Capillary Tubing



Nebulizer Cleaning Wires



Nebulizer Grease

AUTOSAMPLER CUPS AND SUPPLIES

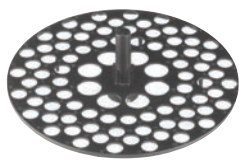

88-Position Tray

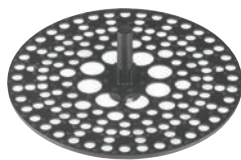

148-Position Tray

Furnace Autosampler Trays

For a quick change to another series of samples, a second sample tray is recommended.

For Model AS-800/AS-900

Description	Part No.
88-Position Tray, Polypropylene 80 sample locations for 2.0, 2.5 or 3.5 mL sample cups. Each sample tray also has eight positions for 7.0 mL reagent containers.	B3001507
148-Position Tray, Polypropylene 132 sample locations for 1.2 mL sample cups and eight locations for 2.5 or 3.5 mL sample cups. Each sample tray also has eight positions for 7.0 mL reagent containers. One is provided with the autosampler.	B3001506
Cover	B3001505
Pipette Arm	B3002046



Furnace Sampling Probe

Made of PTFE, these are capable of pipetting a variety of corrosive matrices and organic solutions.

Features and Benefits

- Works well with solvent and acid-resistant sampling components
- PTFE pipette tips and capillaries reduce contamination
- Easy replacement

Description	Part No.
For Models AS-60/AS-70/AS-71/AS-72/AS-800/AS-900	B0129258

Reagent Containers

For blank solutions, reagent solutions or matrix modifiers.

Description	Part No.
Round Reagent Containers For Models AS-40/AS-60/AS-70/AS-71/AS-72. 25 mL polypropylene. Suitable for organic solutions.	B0101164
30 mL Polystyrene – Not for organic solutions.	B0102332
Cloverleaf-shaped Reagent Containers For Models AS-60/AS-70/AS-71/AS-72. 30 mL polypropylene.	B0132799



GRAPHITE FURNACE AUTOSAMPLER CUPS

Sample cups are of heavy-duty construction to prevent cracking or tipping. Their conical design allows for use of nearly the entire sample.

Your choice of materials:

- **Polystyrene** – Clear, recommended for use with most aqueous solutions
- **Polyethylene** – Translucent, low-density, recommended for use with most aqueous solutions
- **PTFE** – Recommended for use with most concentrated acids including HF, and for analyses where the lowest detection levels are required
- **Polypropylene** – Translucent; preferred for most solvents

Volume	Composition	Qty.	Part No.
1.2 mL*	Polypropylene	2,000	B0510397
2.0 mL	Polyethylene	1,000	B0087056
2.0 mL	Polystyrene	1,000	B0119079
2.0 mL	PTFE	30	B0087600
2.5 mL	Polypropylene	1,000	B3001566
3.5 mL	Polystyrene	100	B0129303
7.0 mL**	Polypropylene	100	B3001567

* For use with AS-71/72/800/900 ** For use with AS-800/AS-900

Pliers and Accessories



Description	Part No.
For 1.2 mL sample cups.	B0510398
Drain Bottle without Cap 2L	B0104344
Rinse Bottle	B0104281

Check Valves

Description	Aqueous Part No.	Organics Part No.
Check Valve Inlet	B3002007	B0105973
Check Valve Outlet	B3002006	B0105974
Inlet and Outlet Kit	B3001485	

QUIET, OIL-LESS AND CLEAN

AA ULTRA QUIET OIL-LESS AIR COMPRESSOR

PerkinElmer is expanding its compressor product portfolio to include an industrial grade, quiet, oil-less compressor for dependable and clean air supply. With the addition of a water separator with a 5 micron particle filter, no liquid transfers into the air supply, providing you with contaminant free air. Each quiet, vibration free compressor comes standard with an internally and externally coated air tank with top drain. The AA Ultra Quiet Oil-Less Air Compressor features a low operating sound level of 60 dB and comes completely outfitted to operate the PerkinElmer Atomic Absorption (AA) Spectrometers.



Features and Benefits:

- Completely quiet oil-less operation
- Delivers clean and dry instrument grade air
- Water separator with 5 micron particle filter and auto drain assures no liquid transfer
- Specialty coated cylinders and high temperature piston rings for long service life
- Durable air tank with top drain and internal/external coating
- Low annual operating costs
- A complete compressed air station incorporating an outlet pressure regulator, tank and outlet pressure gauge, shut off ball valve, ASME safety valve, and pressure switch allowing for complete automatic operation



Specifications	
Horse Power	1 HP
Output CFM	4.2 CFM
Output L.	120 L./min
Max Pressure PSI	120 PSI
Max Pressure Bar	8 bar
Max Current 110V	7.8 Amps
Max Current 220V	3.8 Amps
Noise Level	60 db/A
Tank Size Gal.	6
Tank Size Liters	24
Dimensions	16" x 16" x 21"
Weight	53.8 Lbs.
Packed Dimensions	20" x 20" x 25"
Packed Weight	65.8 Lbs.

Description	Part No.
Compressor 115V/60Hz	N9306345
Compressor 220V/50-60Hz	N9306346

Description	Part No.
Replacement Air Intake Filter	N0777870
Micron Dryer Filter Element	N0777871

ISO 9001-2008
Certified



ISO 13485-2008
Certified



EXCLUSIVE DESIGN ENSURES EVEN HEATING



NEW!

THGA GRAPHITE TUBES WITH ADVANCED PLATFORM™

The exclusive and patented Advanced Platform design offers an alternative to our Standard Integrated Platform design. With the current Integrated Platform design, the platform attaches to the tube wall along a single side that runs the length of the platform. The new Advanced Platform design suspends the platform in the tube using three small pins in a triangular layout. This has the advantage of minimizing wall contact and reducing thermal conduction from the tube walls resulting in even and rapid heating almost exclusively from thermal radiation, an ideal platform.

Advanced Platform Features:

- Even and rapid heating
- Improved sensitivity for some applications
- Improved batch to batch reliability
- Exclusive and patented design - only from PerkinElmer!

Advanced Platform™ THGA Graphite Tubes **NEW!**

Description	Advanced Platform Part No.	Advanced Platform w/End Caps Part No.
5-pack	N9307830	N9307832
20-pack	N9307831	N9307833

STANDARD THGA GRAPHITE TUBES

Today's analysts expect exceptional analytical performance from their graphite furnace atomic absorption spectrometers. That performance must be reproducible from day to day with respect to sensitivity (characteristic mass), accuracy and precision.

The graphite tube, the heart of the graphite furnace, plays a vital role in the overall stability of an analysis. In order to assure stable analytical conditions from one atomization cycle to the next, and from graphite tube to graphite tube, all graphite parts — contacts, tubes and platforms — must be subject to strict quality control by both the instrument manufacturer and the graphite manufacturer.



PerkinElmer's unique, transversely-heated graphite tube includes an integrated platform. The exceptionally uniform temperature distribution obtained with transverse heating significantly reduces or eliminates condensation of the sample matrix components and "memory" effects, and improves the atomization efficiency for refractory elements.

Standard THGA Graphite Tubes

Description	Part No.
5-pack	B3000641
20-pack	B0504033
100-pack	N3110147

Standard THGA Graphite Tubes with End Caps

For improved characteristic mass with volatile and medium refractory elements such as Ag, As, Cd, Co, Cr, Cu, Pb, Se and Tl, the THGA graphite tubes with end caps are recommended. Note: THGA graphite tubes with end caps are not recommended for refractory elements such as V or Ba.

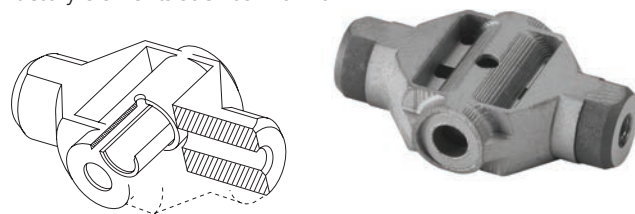

Features and Benefits

- Improved detection limits for volatile and medium refractory elements
- Faster drying for complex matrices due to enlarged dosing hole

Standard THGA Graphite Tubes with End Caps

Description	Part No.
5-pack	B3000653
20-pack	B3000655



UltraClean THGA Graphite Tubes

For the lowest possible detection limits, residual contaminant levels may not be low enough to meet your requirements. For the most demanding analyses, PerkinElmer offers UltraClean THGA graphite tubes — delivering exceptionally low levels of contamination due to advanced high-temperature gas-phase cleaning procedures. UltraClean graphite tubes offer unmatched analytical advantages for special applications such as the determination of extremely low traces of Na, Ca, Fe, Cr and Ni in ultra-clean reagents used in the semiconductor industry, and ultra-trace analyses of environmental, clinical, or food samples.



Features and Benefits

- UltraClean THGA graphite tubes have the lowest possible contamination levels due to extensive high-temperature gas-phase cleaning procedures
- UltraClean THGA graphite tubes are tested and specified for blank levels of Cr, Ni, V, Mo, Ti (<0.003 integrated absorbance units) and Na, Fe, Al, Si, Ca (<0.0005 integrated absorbance units)

UltraClean THGA Graphite Tubes

Description	Part No.
5-pack	B3140361
20-pack	B3140362



THGA Instrument Mirror

Used to optimize drying temperatures and times.



Description	Part No.
THGA Instrument Mirror	B0851900

THGA Contact Cylinders

These graphite contact cylinders are engineered for a precise fit so that variations in electrical contact — which might affect the analytical performance — are reduced to a minimum. Contact cylinders with a modified injection port area help to minimize condensation and improve analytical performance with difficult matrices.



Standard THGA Graphite Contact Cylinders

Description	Part No.
1 pair	B0504035
5 pairs	B0504036

Modified THGA Contact Cylinders

Description	Part No.
1 pair	B3002103
5 pairs	B3002102

Accessories and Spare Parts



Description	Part No.
O-Ring (behind Contact Cylinder, front and back)	B0500748
Contact Cylinder Removal Tools	B3120405
THGA Filter Cartridge AA600 Fume Extractor qty. 50.	B0509065
Spare Graphite Tip for fume extraction system	B0506722
Pliers	09907925
THGA Quartz Window	B0198005
THGA Quartz Window O-Ring	B0501236



Matrix Modifiers for Graphite Furnace AA

PerkinElmer provides you with the maximum performance and the lowest possible detection limits

with our high-quality matrix modifiers.

PerkinElmer matrix modifiers thermally stabilize the analyte, allowing higher pyrolysis temperatures to be used, reducing background absorption, and eliminating potential interferences.

Features and Benefits

- High-purity compounds minimize the risk of contamination
- Optimum graphite furnace program can be used due to reduced analyte volatility

Matrix Modifiers

Modifiers	Concentration	Volume	Part No.
Mg(NO ₃) ₂	1% Mg (as nitrate)	100 mL	B0190634
Pd	1% Pd (as nitrate)	50 mL	B0190635
NH ₄ H ₂ PO ₄	10% NH ₄ H ₂ PO ₄	100 mL	N9303445

MANUFACTURED TO THE HIGHEST QUALITY SPECIFICATIONS

The production of high-quality graphite components requires stringent quality control. To ensure high quality and consistency, a specific grade of high-density base graphite material has been developed for PerkinElmer's exclusive use. This base graphite material is used for the manufacturing of all PerkinElmer graphite tubes.

Selection and careful control of raw materials are extremely important. The composition and the microstructure of the base graphite material determine the specific resistivity of the tube and its heating characteristics.

When you purchase graphite supplies from PerkinElmer, you get the results of our many years of experience with quality graphite parts.

The proper performance, maintenance, and serviceability of our graphite furnace systems can be assured only through the use of genuine PerkinElmer graphite components.

PYROCOATED GRAPHITE TUBES

Grooved Pyrocoated Graphite Tubes

Internally grooved to accept L'vov platforms. Does not include platform.

Description	Part No.
5-pack	B0137111
10-pack	B0121092
20-pack	B3001254
100-pack	N3110146

Pyrocoated Graphite Tubes*

Description	Part No.
5-pack	B0105197
10-pack	B0135653
20-pack	B3000342
20-pack (Forked Platform)	B0505057
50-pack	B0091504

*Not compatible with L'vov platforms

PYROCOATED GRAPHITE TUBES WITH INTEGRATED PLATFORMS

Proven in labs throughout the world, graphite tubes with integrated platforms provide superior performance and are easy to use. Graphite tubes with integrated platforms are machined from one piece of graphite and are totally pyrocoated, providing exceptional tube-to-tube reproducibility. The spherically-shaped platform accommodates up to 50 µL of sample.



Features and Benefits

- Provide STPF conditions for volatile and nonvolatile refractory elements due to the significantly higher heating rates of tube and platform, which can be used for all elements
- Offer an extra measure of convenience versus manually inserting a separate platform
- Provide longer life with many aggressive sample matrices, such as concentrated acids

Pyrocoated Graphite Tubes with Integrated Platforms

Description	Part No.
5-pack	B3001262
20-pack	B3001264
40-pack	N9300651

Uncoated Graphite Tubes*

Description	Part No.
20-pack	B3001253
50-pack	B0070699

*Not compatible with L'vov platforms

NEW! PYROCOATED ADVANCED PLATFORM GRAPHITE TUBES

The exclusive and patented Advanced Platform design offers an alternative to our Standard Integrated Platform design. With the current Integrated Platform design, the platform attaches to the tube wall along a single side that runs the length of the platform. The new Advanced Platform design suspends the platform in the tube using three small pins in a triangular layout. This has the advantage of minimizing

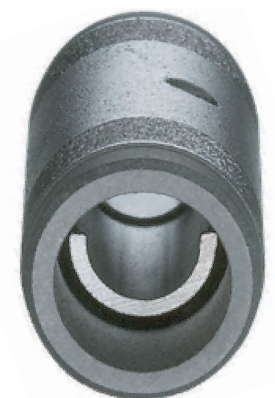

wall contact and reducing thermal conduction from the tube walls resulting in even and rapid heating almost exclusively from thermal radiation, an ideal platform.

Advanced Platform Features:

- Even and rapid heating
- Improved sensitivity for some applications
- Improved batch to batch reliability
- Exclusive and patented design - only from PerkinElmer!

Graphite Tubes with Advanced Platform **NEW!**

Description	Part No.
5-pack	N9307834
20-pack	N9307835

L'VOV PLATFORMS

The L'vov platform is a small plate of solid pyrocoated graphite that is inserted into the graphite tube. It has a slight depression in the center, which can accommodate up to 50 μL of solution. The function of the L'vov platform is to isolate the sample from the tube walls to allow more reproducible atomization of the sample through indirect heating. The platform heats primarily by the radiation given off from the tube walls. Sample vaporization and atomization occur after the tube reaches a steady-state temperature.



Use of the L'vov platform provides:

- Vaporization into a higher temperature gas atmosphere producing more free atoms, which reduce interferences
- Longer tube life because aggressive samples are only in contact with the solid pyrolytic graphite platform

Description	Part No.
20-pack	B3001256
100-pack	N3110145

Pyrocoated Graphite Tube with L'vov Platform

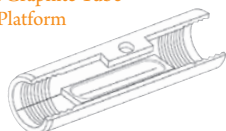

Cross-section of the PerkinElmer HGA graphite tube with manually inserted L'vov platform shown.

Pyrocoated Graphite Tube with Integrated Platforms

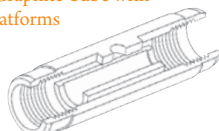

Cross-section of the PerkinElmer HGA graphite tube with integrated platform shown.

CONTACT CYLINDERS

The graphite contact cylinders used in the HGA Graphite Furnace are engineered for a precise fit so that variations in electrical contact — which might affect the analytical performance — are reduced to a minimum. The graphite contacts are shaped so that they completely encase the graphite tube. Thus, the graphite tube is located in a defined inert environment, which ensures uniform heating conditions and long tube lifetime.



Contact Cylinders

For HGA-900/850/800/700/600/300/PinAAcle H Furnaces

- Includes left-hand Contact, right-hand Contact, Shield Ring

Description	Part No.
1 set	B0128495
5 sets	B3130086

HGA Contact Removal Tool

Description	Part No.
HGA 900/AA 700/800/PinAAcle 900	B3121301

HGA Instrument Mirror

Used to optimize drying temperatures and times.



Description	Part No.
HGA Instrument Mirror	B0080259

Matrix Modifiers for Graphite Furnace AA

PerkinElmer provides you with the maximum performance and the lowest possible detection limits with our high-quality matrix modifiers.



PerkinElmer matrix modifiers thermally stabilize the analyte, allowing higher pyrolysis temperatures to be used, reducing background absorption, and eliminating potential interferences.

Modifiers	Concentration	Volume	Part No.
Mg(NO ₃) ₂	1% Mg (as nitrate)	100 mL	B0190634
Pd	1% Pd (as nitrate)	50 mL	B0190635
NH ₄ H ₂ PO ₄	10% NH ₄ H ₂ PO ₄	100 mL	N9303445



AA GRAPHITE FOR NON-PERKINELMER INSTRUMENTS

PerkinElmer supplies a wide range of graphite tubes for non-PerkinElmer instrumentation. Graphite tubes are made with the highest quality material guaranteed to work for your AA instrument.

Use the convenient tables below to identify the compatible graphite furnace tube for your AA instrument.

GBC Instruments

Description	Qty/pack	GBC Part No.	Part No.
Standard tube, pyrolytically coated	10	99-0059-00	N9304600
Platform, pyrolytically coated	10	99-0060-00	N9304601
Standard tube, coated, with Omega-platform	10	99-0342-00	N9304602
Electrode contacts	2	99-0061-00	N9304603
Shroud	1	45-0004-00	N9304604

Hitachi® Instruments

Description	Qty/pack	Hitachi® Part No.	Part No.
Standard tube, pyrolytically coated	10	180-7444	N9304600
Standard tube, uncoated	10	180-7400	N9304601
Standard platform, pyrolytically coated	10	180-7404	N9304602
Tube for extended injection volume, pyrolytically coated	10	190-6003	N9304603
Contacts, AD 20 mm	2	180-7401	N9304604
Zeeman contacts, AD 18 mm	2	172-8805	N9304610
Omega Tube	10	N/A	N9304611

Shimadzu® Instruments

Description	Qty/pack	Shimadzu® Part No.	Part No.
Standard tube, pyrolytically coated (90° contact cone)	10	206-50588	N9304612
Standard tube, uncoated (90° contact cone)	10	206-50587	N9304613
Tube with built-in platform, coated (90° contact cone)	10	206-5887-02RI	N9304614
Left Electrode with housing (90° cone)	1	206-50602	N9304615
Right Electrode (90° cone)	1	206-50603	N9304616

Thermo® Instruments

Description	Qty/pack	Thermo® Part No.	Part No.
Partridge tube, uncoated	10	9423 393 95031	N9304617
Partridge tube, coated	10	9423 393 95071	N9304618
Partridge tube, coated (extended lifetime)	10	9423 393 95041	N9304619
Zeeman Electrode Contact	2	9423 393 95161	N9304620
Standard Electrode Contact	2	9423 393 95011	N9304621
Omega Tube	10	9423 490 20101	N9304622

Agilent® Instruments

Description	Qty/pack	Agilent Part No.	Part No.
Plateau tube, pyrolytically coated	10	63-100011-00	N9304623
Bone platform, pyrolytically coated (for use in plateau tubes)	10	63-100013-00	N9304624
Partition tube, pyrolytically coated	10	63-100012-00	N9304625
Partition tube, uncoated	10	63-100015-00	N9304626
Partition tube, pyrolytically coated extended life	10	63-100012-EL	N9304627
Omega-platform tube	10	63-100037-00	N9304628
Shroud	1	63-100018-00	N9304629
Electrode	2	63-100016-00	N9304630
Zeeman Shroud	1	63-100019-00	N9304631
Zeeman Electrode (Older Instruments)	2	63-100017-00	N9304632
Zeeman Electrode (Newer Instruments)	2	63-100035-00	N9304633
Zeeman Shroud GTA120, pyrocoated	1	63-100036-00	N9304634

See Atomax 1.5" hollow cathode lamps for non-PerkinElmer instruments on page 19.



SMS 100 Consumables and Supplies

Description	Part No.
Nickel Boats (Qty. 42)	N9309017
Quartz Combustion Boats (Qty. 10)	N9309032
Replacement Carbon 500 g	N9309035
Catalyst Tube (Packed)	N9309036
Autosampler Boat Shuttle	N9309019
Exhaust Tubing Assembly	N9309006
Amalgamator Tube	N9309007
Mercury Lamp	N9309010
Hg Vapor Trap Kit with Carbon Material	N9309011
Nafion® Drying Tube	N9309021
Sample Substrate 250 mL	N9309103
Oxygen Two Stage Regulator	N9309004
Oxygen, Nitrogen, Argon Supply	N9309009
Autosampler Boat Shuttle	N9309019
UV Windows ½ d x ¼ t 10–20 w (Qty. 2)	N9309024
O-Ring ¼ i.d. x ¼ w Viton	N9309025
O-Ring Amalgamator ¼ i.d., ¾ o.d. Viton	N9309026
O-Ring Injector ⅝ i.d., o.d. ¾	N9309027
O-Ring Catalyst Front Viton	N9309028
O-Ring .414D Catalyst Rear	N9309030
O-Ring Kit for SMS 100	N9309029
High Sensitivity Absorption Cell 5 inch	N9309033
Low Sensitivity Absorption Cell 1 inch	N9309034



PerkinElmer SMS 100 Mercury Analyzer

The SMS 100 is a dedicated mercury analyzer for the determination of total mercury in solid and liquid samples using the principle of thermal decomposition, amalgamation and atomic absorption described in U.S. EPA Method 7473.

The SMS 100 uses a decomposition furnace to release mercury vapor instead of the chemical reduction step used in traditional liquid-based analyzers. Both solid and liquid matrices can be loaded onto the instrument's autosampler and analyzed without acid digestion or sample preparation prior to analysis. Some of the many sample matrices applicable to SMS 100 technology include sludges, sediments, soils, wastewaters, effluents, coal, fly ash, minerals, ores, fertilizers, various foodstuffs, blood, urine and hair.



Amalgamator Tube



Catalyst Tube



Nickel Boat

Spares Kits

Description	Qty	Part No.
Basic Spares Kit		N9309109
Kit Includes:		
Amalgamator Tube	1	N9309007
Mercury Source Lamp	1	N9309010
Nafion® Drying Tube	1	N9309021
O-Ring Kit	1	N9309029

Description	Qty	Part No.
Extended Spares Parts Kit		N9309110
Kit Includes:		
Amalgamator Tube	2	N9309007
Sample Gas Tubing Assembly	1	N9309008
Mercury Source Lamp	1	N9309010
Injector Fork Assembly	1	N9309012
CVAAS Tubing Kit	1	N9309013
Amalgamator Heater Coil	1	N9309066
6 g Krytox® Tube Grease	1	N9309108
Nafion® Drying Tube	1	N9309021
Quartz Windows	6	N9309024
O-Ring Kits	2	N9309029
Window End Caps	8	N9309031
5 inch Optical Cells	2	N9309033
1 inch Optical Cell	1	N9309034



MEINHARD® NEBULIZERS

The MEINHARD® concentric glass nebulizers reflect exacting standards in design and manufacturing. They provide excellent sensitivity and precision for aqueous solutions and samples with few dissolved solids (less than 1%). Meinhard nebulizers for Optima include Standard Nebulizer Solution Fitting, 0.5 mm PTFE (N0777414) and PFA Gas Quick Connect (N8121036).



Nebulizer Solution Fitting (N0777414)



Nebulizer Clip (N0777460)



PFA Gas Quick Connect (N8121036)

For Optima 2x00/3x00/4x00/5x00/7x00/8x00

Type	Ar Flow Rate	Uptake Rate	Part No.
Type A3	1 L/min	3 mL/min	00472020
Type C1**	1 L/min	1 mL/min	00472022
Type K3	0.7 L/min	3 mL/min	N0681574
Type K1*	1 L/min	1 mL/min	N0777707
Standard nebulizer solution fitting, 0.5 mm PTFE. 0.5mm x 70 cm capillary			N0777414
Nebulizer Clip for Meinhard Nebulizers, Qty. 1			N0777460
PFA Gas Quick Connect			N8121036

*Standard with Optima 8x00 instrument.

**Standard for Optima 2x00/4x00/5x00/7x00 Instrument



End Cap for Concentric Nebulizers

End cap to fit any concentric nebulizer onto a Scott Spray Chamber.

ICP Model	Part No.
Optima 2x00/3x00/4x00/5x00/7x00/8x00	N0680504



MIRA MIST® NEBULIZERS

For Optima 2x00/3x00/4x00/5x00/7x00/8x00

Description	Uptake Rate	Part No.
PEEK Mira Mist Excellent mist, and can handle high level of particulates in sample.	0.2 to 2.5 mL/min	N0775330
PTFE Mira Mist For samples with high HF, Sulphuric, and some other solvents that attack Peek.	0.2 to 2.5 mL/min	N0777031
Ari Mist Very Low Sample Flow	0.050 to 1.0 mL/min	N0777032
T2100 For high levels of undissolved solids such as oil samples, geologic samples, and slurries.	0.5 to 3.0 mL/min	N0777033

CONCENTRIC NEBULIZERS FOR A WIDE VARIETY OF APPLICATIONS



Shown with UniFit Connector

MICROMIST™ NEBULIZERS

The MicroMist micro-uptake glass concentric nebulizer offers high performance for limited sample volumes. MicroMists with sample uptakes 0.2 – 0.6 mL/min are fitted with a UniFit connector with 1.3 mm o.d. x 0.50 mm i.d. x 700 mm long sample tubing (N0777513). MicroMists with sample uptakes 0.05 – 0.1 mL/min are fitted a UniFit connector with 1.3 mm o.d. x 0.25 mm i.d. x 700 mm long sample tubing (N0777514). EzyLok Connector Kit (N0777413) included. Material: Borosilicate glass.

For Optima 2x00/3x00 XL/3x00 DV/3000 SCX/4x00/5x00/7x00/8x00

Ar Flow Rate	Uptake Rate	Part No.
0.7 L/min	0.05 mL/min	N0775349
0.7 L/min	0.1 mL/min	N0775348
0.7 L/min	0.2 mL/min	N0775347
0.7 L/min	0.6 mL/min	N0775346



Mira Mist Spares

Description	Pkg.	Part No.
0.5 meters 0.44" OD x .018" ID	1	N0777111
0.5 meters 0.44" OD x .018" ID	10	N0777112
2 mm gas line with upchurch fittings	1	N0777113
Mira Mist Quick Release	1	N0777114
1/4" Adapter	1	N0777115
0.44" OD x .018" ID polyethylene tubing 3M	1	N0777116
0.44" OD x .018" ID polyethylene tubing 30M	1	N0777117

SEASPRAY™ NEBULIZERS

The SeaSpray concentric nebulizer is ideal for samples with high dissolved solids and offers outstanding nebulization efficiency for trace level analyses. It offers freedom from clogging while nebulizing solutions to the limit of solubility of most mineral salts and conferring significant sensitivity gains. Includes UniFit Connector with 0.75 mm ID x 1.3mm OD x 700 mm long tubing (N0777512) and EzyLok Connector Kit (N0777413). Material: Borosilicate glass.



For Optima 2x00/3x00 XL/3x00 DV/3000SCX/4x00/5x00/7x00/8x00

Ar Flow Rate	Uptake Rate	Part No.
0.7 L/min	2 mL/min	N0775345

For Optima 3000/3000 SCR/3x00 RL

Ar Flow Rate	Uptake Rate	Part No.
1.0 L/min	2 mL/min	N0775340

Conikal™ Nebulizer

Ideal for samples containing only moderate concentrations of dissolved salts, no particulates, and no hydrofluoric acid. Material: Borosilicate glass.



For Optima 2x00/3x00 XL/3x00 DV/3000SCX/4x00/5x00/7x00/8x00

Uptake Rate	Part No.
2 mL/min	N0777487

Slurry™ Nebulizer

Ideal for the analysis of used engine oils for wear metals. A sample which consists of small particulates in liquid matrix is a slurry and is suited to this nebulizer. Material: Borosilicate glass.



For Optima 2x00/3x00 XL/3x00 DV/3000SCX/4x00/5x00/7x00/8x00

Uptake Rate	Part No.
4 mL/min	N0777488

Ceramic VeeSpray™ Nebulizer

The Ceramic VeeSpray nebulizer is made from alumina ceramic, making it ideal for HF analyses. It provides reproducible performance when working with samples containing large particulates. Material: 99.8% Alumina Ceramic.



For Optima 2x00/3x00 XL/3x00 DV/3000SCX/4x00/5x00/7x00/8x00

Uptake Rate	Part No.
0.6 - 3.0 mL/min	N0777489

PolyCon™ Nebulizer

For routine high precision analyses involving samples digested in HF and are not high in dissolved solids. Material: HF Resistant Polyimide.



For Optima 2x00/3x00 XL/3x00 DV/3000SCX/4x00/5x00/7x00/8x00

Uptake Rate	Part No.
2 mL/min	N0777490

DuraMist™ Nebulizer

The DuraMist is an economical nebulizer for high precision analyses involving samples digested in HF. Recommended for samples containing up to 5% HF. For samples with higher concentrations of HF, the OpalMist PFA nebulizer is recommended. Material: HF Resistant PEEK



For Optima 2x00/3x00 XL/3x00 DV/3000SCX/4x00/5x00/7x00/8x00

Ar Flow Rate	Uptake Rate	Part No.
0.7L/min	0.4 mL/min	N0777713
0.7L/min	1.0 mL/min	N0777714

OpalMist™ Nebulizer

For high precision analyses requiring the highest chemical resistancy of HF, alkalis and organics. The OpalMist is capable of aspirating high concentrations of dissolved solids without clogging. An ideal nebulizer to handle geochemical samples which are typically dissolved in HF and are high in dissolved solids. Material: PFA.



For Optima 2x00/3x00 XL/3x00 DV/3000SCX/4x00/5x00/7x00/8x00

AR Flow Rate	Uptake Rate	Part No.
0.7 L/min	0.6 mL/min	N0777735
0.7 L/min	0.05 mL/min	N0777738
0.7 L/min	0.1 mL/min	N0777737
0.7 L/min	0.2 mL/min	N0777736
0.7 L/min	2 mL/min	N0777734



The Eluo™ Nebulizer Cleaner

The Eluo is designated to efficiently deliver a cleanser through the nebulizer capillary to dislodge particle build-up and thoroughly clean the nebulizer. One simple action does it all. No more messy procedures, waiting overnight or shattered nebulizers in ultrasonic baths.

Description	Part No.
For Newer OpalMist, PolyCon, DuraMist, Meinhard, other Glass Nebulizers.	N0777712
For OLD style OpalMist or PolyCon Nebulizers	N0775358

Connectors for MicroMist and SeaSpray Nebulizers



Description	Pkg.	Part No.
UniFit		
0.25 mm ID x 1.3 mm OD x 700 mm long	10	N0777514
0.50 mm ID x 1.3 mm OD x 700 mm long	10	N0777513
0.75 mm ID x 1.3 mm OD x 700 mm long	10	N0777512
1.30 mm OD X 0.75 mm ID x 700 mm long	3	N0774077
1/16 inch OD x 0.25 mm ID x 700 mm	10	N0777845
1/16 inch OD x 0.50 mm ID x 700 mm	10	N0777846
1/16 inch OD x 0.75 mm ID x 700 mm	10	N0777847
1/16 inch OD X 0.75 mm ID x 700 mm long	3	N0774080
UniFit-EzyFit Sample Tube	6	N0777061
EzyFit		
0.25 mm ID x 1.27 mm OD x 700 mm long	10	N0777437
0.50 mm ID x 1.27 mm OD x 700 mm long	10	N0777436
0.75 mm ID x 1.27 mm OD x 700 mm long	10	N0777435
0.25 mm ID x 1/16" OD x 700 mm long	10	N0777464
0.50 mm ID x 1/16" OD x 700 mm long	10	N0777463
0.50 mm ID x 1/16" OD x 700 mm long Twin	6	N0777462
UniFit-EzyFit Sample Tube	6	N0777061

EzyLok Kit for Nebulizer Gas Side Arm



Description	Part No.
EzyLok Kit - Includes: EzyLok Connector for 4mm Tubing, EzyLok 6mm Hose Adaptor, Nebulizer Hose Clip	N0777413



Description	Part No.
Nebulizer Pressure Hose Clips (standard)	N0773197
Nebulizer Clip for Meinhard Nebulizers	N0777460

PFA Nebulizer Obstruction Removal Kit



While naturally resistant to obstructions, PFA nebulizers may occasionally require maintenance. Use this kit to safely remove obstructions in all PFA-ST nebulizers for long-term high performance.

Description	Part No.
Nebulizer Obstruction Removal Kit	N8145236

HIGH EFFICIENCY MICROFLOW NEBULIZERS

MicroFlow nebulizers are resistant to clogging, reliably self-aspirated or pumped to produce a fine aerosol for high transport efficiency and high sensitivity.

PFA-ST Nebulizer

The PFA-ST MicroFlow nebulizer is made from high purity, HF resistant PFA. It has an exchangeable external sample uptake capillary. The sample uptake rate is controlled by the diameter of the external capillary or probe.



Features:

- Chemically resistant—ideal for strong acids, alkalis and organics
- Can be pumped from < 0.1 mL/min to 3.0 mL/min
- Direct analysis of volatile and non-volatile organic solvents

Description	Part No.
PFA-ST Nebulizer	N0777049

PolyPro-ST Nebulizer

The PolyPro-ST Nebulizer is an HF resistant alternative to the PFA nebulizers but has the same high efficiency aerosol generation. It is a robust nebulizer that can self aspirate with an exchangeable external sample uptake capillary or be used with a peristaltic pump.



Description	Part No.
PolyPro-ST Nebulizer	N0777219

PFA-ST3 Nebulizer

The PFA-ST3 Nebulizer is designed for superior clog resistance and higher sensitivity compared to the standard PFA nebulizer.



Description	Part No.
PFA-ST3 Nebulizer	N0777676

Sample Capillaries for ST Nebulizers

I.D.	Self-aspiration rate I.D. (@1L/m Ar)	Part No.
0.15 mm	20 µL/min (red)	N8122382
0.2 mm	50 µL/min (purple)	N8145135
0.25 mm	100 µL/min (green)	N8122383
0.3 mm	200 µL/min (yellow)	N8145136
0.5 mm	400 µL/min (orange)	N8122384
0.8 mm	700 µL/min (blue)	N8145137
1.0 mm	1 mL/min (gray)	N8145138



GemCone™ Low-Flow Nebulizers

Low-flow GemCones permit lower nebulizer gas flow rates, useful for spectral lines with high excitation energies and for providing a more robust plasma. GemCone Nebulizers require an end cap for use with Scott Spray Chambers.

ICP Model	Part No.
2x00/4x00/5x00/7x00/8x00	N0770358



GemCone High Dissolved Solids Nebulizer

High solids GemCones are for samples with high dissolved solids (up to 20%). This conespray nebulizer allows you to analyze samples with higher solids concentration than is possible with a

Cross-Flow nebulizer. GemCone nebulizers require an end cap for use with Scott Spray Chambers.

Description	Part No.
GemCone High Dissolved Solids Nebulizer	N0690670



GemCone Nebulizer Accessories

Description	Part No.
GemCone Sample Capillary Adapter	N0371505
End Cap for GemCone Nebulizers	N0680504
Quick Disconnect Tubing with Swagelock	N0770336
Quick Disconnect Tubing without Swagelock	N0770610
Capillary Tubing (10 ft.)	09908265
PTFE Capillary Tubing (1 FT.)	09985708

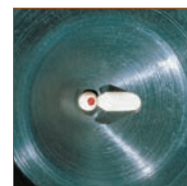

GemTip Cross-Flow II Nebulizers

Excellent general purpose nebulizer for the analysis of strong mineral acids (including HF) and samples with less than 5% dissolved solids. It can routinely handle 50% (v/v) solutions of HCl, HNO₃, H₂SO₄, H₂PO₄, 20% (v/v) HF and 30% (v/v) NaOH. Up to 20% NaCl can be aspirated by the nebulizer for 1 hour without clogging. Uses chemically resistant GemTips made of sapphire and ruby in a chemically resistant end cap.

ICP Model	Part No.
8x00	N0780546
2x00/4x00/5x00/7x00	N0770546

GemTip Cross-Flow II Nebulizer Tip Kits

The Tip Kit includes a clear sapphire sample tip and a red ruby argon tip. The tips are constructed of PEEK with the gem inserts noted for maximum corrosion resistance.



ICP Model	Part No.
8x00	N0780676
2x00/4x00/5x00/7x00	N0690676
O-Ring for GemTip II Tips qty. 1	09921045

Argon Humidifier with Bypass

The Argon Humidifier is commonly used in ICP analyses of samples with very high dissolved solids concentration. Helping to prevent salt build-up inside the sample introduction system, the Argon Humidifier allows uninterrupted and maintenance-free operation. The Argon Humidifier combines ease of operation, high performance and safety.



ICP Model	Part No.
Optima 2x00/4x00/5x00/7x00/8x00	N0775331



Standard Cyclonic
Spray Chamber
Part No. N0776052

Cyclonic
O-Ring Free
Part No. N0775351

Cinnabar Spray
Chamber
Part No. N0777494

Cyclonic Spray Chambers

The spray chamber is an integral part of the sample introduction system responsible for filtering the sample mist to permit the appropriate droplet size distribution to reach the plasma.

Save Time and Expense

- Decreased sample introduction system installation and optimization time due to the preset nature of the spray chamber/nebulizer combination
- More samples per hour due to minimal dead volume and efficient draining

Unique Design Characteristics

- The nebulizer port is oversized so that sample solution cannot build up around the nebulizer as it will in other cyclonic designs. This translates to less carryover, faster washout times and greater productivity from your Optima
- Each spray chamber incorporates a precisely-machined ridge along the inside top of the spray chamber. Both the angle and depth of the ridge are critical to performance. The result is efficient draining of sample waste and the elimination of large droplets being swept into the plasma. This eliminates the periodic “spiking” that adversely affects precision and fosters faster washout times

Standard and O-Ring Free glass cyclonic spray chambers can be used with either GemCone or concentric glass nebulizers. HF resistant cyclonic spray chambers should be used with GemCone, SeaSpray or MicroMist nebulizers.

ICP Model	Type	Part No.
2x00/4x00/5x00/7x00/8x00	Standard*	N0776052
2x00/4x00/5x00/7x00/8x00	O-Ring Free	N0775351
2x00/4x00/5x00/7x00/8x00	O-Ring Free with Easy-Seal Threaded	N0772017

*Standard Cyclonic Spray Chamber (N0776052) with Adapter (N0770614); Spray Chamber Kit with Mount Part No. N0770605

See Sample Introduction Kits for complete spares kits.

MAXIMUM SENSITIVITY AND EFFICIENCY

Cinnabar™ 20mL Glass Cyclonic Spray Chamber

The Cinnabar spray chamber is a mini-cyclonic spray chamber which gives good sensitivity at very low uptakes. The Cinnabar's design and low volume is ideal for the reduction of memory and matrix effects and very fast washout. Volume 20 mL.

ICP Model	Type	Part No.
2x00/4x00/5x00/7x00/8x00	O-Ring Free	N0777494



Part No. N0770600 Part No. N0770614

Accessories and Drain Parts

Description.	Part No.
Cyclonic Spray Chamber Adapter	N0770614
Mounting Block only	N0770600
Drain Adapter Assembly for Scott Spray Chamber Includes the spray chamber fitting and tubing to pump out the waste solution from the spray chamber (does not include the peristaltic pump tubing)	N0770613
Carboy, 15 L	09904991
Drain Cap Assembly	N0690271



Part No. N0777439

Part No. N0777438

Connectors and Spares

Description	Pkg.	Part No.
EzyLok Connector for Jacketed Spray Chamber	4	N0774101
Helix Locking Screw	1	N0777438
Helix Seal	4	N0777439
Nebulizer Adaptor Plug 16/6 for N0776052 Spray Chamber		N0776006
O-Ring Set for Nebulizer Adaptor Plug 16/6		N0776007
O-ring kit for Tracey TFE Spray Chamber (N0777496) with Helix		N0777844



Oxygen Port Spray Chamber
Part No. N077731

Baffled Cyclonic Spray Chambers

The Baffled Cyclonic Spray Chamber features a central transfer tube which acts as a secondary particle separator, helping to separate larger aerosol particles from the sample. This reduces solvent load in the plasma without compromising detection limits.

Features and Benefits

- The distance between the bottom of the baffle and the chamber wall is carefully controlled so that droplets cannot form on the bottom of the baffle. The advantage is smooth draining and improved precision
- The baffle is cut at a sharp angle so that a large cross-section of the spray chamber is sampled as opposed to a straight cut which would have a very small sampling cross-section. The advantage is more representative sampling and reduced matrix effect

ICP Model	Type	Part No.
2x00/4x00/5x00/7x00 DV/8x00	Standard	N0776053
2x00/4x00/5x00/7x00 DV/8x00	O-Ring Free	N0775352
2x00/4x00/5x00/7x00 DV/8x00 20mL	O-Ring Free	N0777495
2x00/4x00/5x00/7x00 DV/8x00 for Oil Analysis (4 mm baffle)	Standard	N0776090
2x00/4x00/5x00/7x00 DV/8x00 for Oil Analysis (4 mm baffle)	O-Ring Free	N0775355
2x00/4x00/5x00/7x00 DV/8x00 for Oil Analysis (4 mm baffle) with Oxygen Port	O-Ring Free	N0777731
4300V/5300V/7300V	Standard	N0771501
4300V/5300V/7300V	O-Ring Free	N0775356

Metal Ball Joint Clip



Used to connect spray chamber and torch. Includes tension screw for 4300V/5300V/7300V instrument.

Description	Part No.
Metal Ball Joint Clip	N0773114

HF Spray Chamber
Part No.
N0777497



HF Spray Chamber
Part No.
N0777496



HF Resistant Spray Chambers

ICP Model	Type	Part No.
4300/5300/7300V TFE PTFE, 50mL	O-Ring Free	N0777497
2x00/4x00/5x00/7x00 DV/8x00 TFE PTFE, 50mL	O-Ring Free	N0777496
O-ring kit for N0777496 Spray Chamber		N0777844



Scott Spray Chamber
Part No. N0770357

Scott Spray Chambers

The Scott Spray Chamber is made from corrosion-resistant material, which is inert to most mineral acids including HF, aqua regia and all organic solvents normally used in ICP analyses. The Scott-type design minimizes pulsations from the peristaltic pump. The Type II, two-piece design ensures leak-free performance. The removable inner tube allows the chamber to be easily disassembled for cleaning.

ICP Model	Part No.
2x00/4x00/5x00/7x00/8x00	N0770357
3000/3000 SCR/3x00 RL	N0690640
3x00 DV/XL/3000 SCX	N0690720

See Sample Introduction Kits for complete spares kits.



Quick-Change Torch Module with Cyclonic Spray Chamber and Concentric Nebulizer

Complete torch and sample introduction module including complete Single-Slot Demountable Torch, mounting block, 2 mm Alumina Injector, Cyclonic Spray Chamber and MEINHARD® Concentric Nebulizer.

ICP Model	Part No.
8x00	N0780607
2x00/4x00/5x00/7x00	N0770607

Mounting Block

Mounting block only. Does not include torch, injector, spray chamber or nebulizer.



ICP Model	Part No.
Optima 2x00/4x00/5x00/7x00/8x00	N0770600

Quick-Change Torch Module for HF Analysis

Description	ICP Model	Part No.
HF-Resistant Analysis Includes GemCone High Dissolved Solids Nebulizer, Alumina 2.0 mm Injector, Quartz 3-Slot Torch, HF-Resistant Baffled Cyclonic Spray Chamber	Optima 4300V/5300V/7300V	N0770911

Quick-Change Torch Module for Oil Analysis

Description	ICP Model	Part No.
Used Oil Analysis Includes GemCone Nebulizer, Alumina 1.2 mm Injector, Quartz 3-Slot Torch, Baffled Cyclonic Spray Chamber	Optima 4300V/5300V/7300V	N0770910

QUICK-CHANGE FOR MAXIMUM EFFICIENCY



Quick-Change Torch Module with Scott Spray Chamber and GemTip Cross-Flow II Nebulizer

Complete torch and sample introduction module including Demountable Single-Slot Torch, mounting block, 2 mm Alumina Injector, Scott Spray Chamber and GemTip Cross-Flow II Nebulizer. Useful when a separate sample introduction is required for running different sample types.

ICP Model	Part No.
8x00	N0780606
2x00/4x00/5x00/7x00 DV	N0770606
3000/3000 SCR/3x00 RL	N0690610
3x00 DV	N0690812
3x00 XL/3000 SCX	N0690712

Quick-Change Torch Module Support Stand

A free-standing support stand to hold your spare Quick-Change Torch Module or as a means of conveniently holding your module when working inside the sample compartment.



ICP Model	Part No.
2x00/4x00/5x00/7x00 DV/8x00	N0770609

OPTIMA™ ICP-OES SAMPLE INTRODUCTION KITS



Description	Part No.
Cyclonic/Concentric Kit 8x00	N0780617
1 Slot Quartz Torch	N0780130
2.0 mm i.d. Alumina Injector	N0781014
Glass Cyclonic Spray Chamber	N0776052
Meinhard® Type K1 Nebulizer	N0777707
Quartz Torch Copper Ignitor Tape – Qty. 50 pcs.	N0781097

Description	Part No.
Cyclonic/Concentric Kit 2x00/4x00/5x00/7x00 DV	N0770730
1 Slot Quartz Torch	N0770338
Quartz Bonnet	N0775289
2.0 mm i.d. Alumina Injector	N0775177
Glass Cyclonic Spray Chamber	N0776052
Meinhard® Type C High Dissolved Solids Nebulizer	00472022
Quartz Torch Copper Ignitor Tape – Qty. 120 pcs.	N0775297



Description	Part No.
Scott/Cross-Flow II Kit 8x00	N0780616
1 Slot Quartz Torch	N0780130
2.0 mm i.d. Alumina Injector	N0781014
Scott Spray Chamber	N0770357
GemTip™ Cross-Flow II Nebulizer	N0780546
Quartz Torch Copper Ignitor Tape – Qty. 50 pcs.	N0781097

Description	Part No.
Scott/Cross-Flow II Kit 2x00/4x00/5x00/7x00 DV	N0770731
1 Slot Quartz Torch	N0770338
Quartz Bonnet	N0775289
2.0 mm i.d. Alumina Injector	N0775177
Scott Spray Chamber	N0770357
GemTip™ Cross-Flow II Nebulizer	N0770546
Quartz Torch Copper Ignitor Tape – Qty. 120 pcs.	N0775297

Description	Qty	Part No.
Organics Kit 8x00		N0780608
3 Slot Quartz Torch	2	N0780132
1.2 mm i.d. Alumina Injector	2	N0781007
Baffled Cyclonic Spray Chamber 4 mm	1	N0776090
GemCone™ Low-Flow Nebulizer	1	N0770358
Cyclonic Spray Chamber Adapter	1	N0770614
Injector Adapter Washer	1	N0776014
Injector Adapter	1	N0776091
Injector Adapter Nut	1	N0776025
O-Ring	1	09902207
O-Ring 8.74 ID 1.78 WD	2	09921028

Description	Qty	Part No.
Organics Kit 2x00/4x00/5x00/7x00 DV		N0770420
3 Slot Quartz Torch	1	N0772005
1.2 mm i.d. Alumina Injector	1	N0776093
Baffled Cyclonic Spray Chamber 4 mm	1	N0776090
GemCone™ Low-Flow Nebulizer	1	N0770358
Cyclonic Spray Chamber Adapter	1	N0770614
Injector Adapter Washer	1	N0776014
Injector Adapter Nut	1	N0776025
Injector Adapter	1	N0776091
O-Ring	1	09902207
O-Ring 8.74 ID 1.78 WD	2	09921028

Description	Part No.
Organics Kit 4300 V/5300 V/7300 V	N0770732
3 Slot Quartz Torch	N0771500
Quartz Bonnet	N0775289
1.2 mm i.d. Alumina Injector	N0771531
Baffled Cyclonic Spray Chamber	N0771501
GemCone™ Low-Flow Nebulizer	N0770358
Quartz Torch Copper Ignitor Tape – Qty. 120 pcs.	N0775297

Description	Qty	Part No.
DV Oxygen Addition Kit 2x00/4x00/5x00/7x00/8x00 DV		N0770689
Baffled Cyclonic Spray Chamber 4mm for Oils w/Oxygen Port	1	N0777731
Tygon Tubing	25 ft.	02506516
Insert	4	09903094
Tube Fitting	2	09903150
Mass Flow Controller	1	N0772006
Adapter for Cyclonic Spray Chamber	1	N0770614

Description	Qty	Part No.
V Oxygen Addition Kit 4300 V/5300 V/7300 V		N0770965
Torch Adapter with auxiliary oxygen port	1	N0774070
Tygon Tubing Per Iç/0.3M	25 ft.	02506516
Insert	4	09903094
Tube Fitting	2	09903150
Mass Flow Controller	1	N0772006

TORCHES AND TORCH ACCESSORIES

Flat Plate Torch
Part No. N0780130



DEMOUNTABLE QUARTZ TORCHES

Demountable design using one-piece quartz tubing for plasma and auxiliary gas flow. Torches without slots are recommended for organic solvents. 1-slot torches are the standard torch for aqueous solutions. 3-slot torches are typically used for organic analysis.

ICP Model	Number of Slots	Part No.
8x00	0	N0780133
8x00 (Standard)	1	N0780130
8x00	3	N0780132
2x00/4x00/5x00/7x00 DV	0	N0770343
2x00/4x00/5x00/7x00 DV (short ver.)	0	N0770344
2x00/4x00/5x00/7x00 DV	1	N0770338
2x00/4x00/5x00/7x00 DV	3	N0772005
2x00/4x00/5x00/7x00 DV Organics Torch	3	N0772008
4300V/5300V/7300V	3	N0771500
7300 V Organics Torch	3	N0771561
3x00 DV	1	N0691662
3000 SCX/3x00 XL	0	N0695379
3000/3000 SCR/3x00 RL	1	N0690568
3000/3000 SCR/3x00 RL	3	N0681690

Torch Bonnets

The torch bonnet is used as a spacer between the torch and RF load coil.



ICP Model	Part No.
2x00/4x00/5x00/7x00	N0775289
3000/3000 SCR/3x00 RL (for instruments manufactured BEFORE 9/21/94)	N0695295
3000/3000 SCR/3x00 RL (for instruments manufactured AFTER 9/21/94)	N0695456
3X00 XL/3x00 DV	N0691664



Torch O-Rings

ICP Model	Dimensions	Part No.
8x00 Complete O-Ring Kit Includes: 09200078 (1), 09902131 (1), 09902223 (2), 09921061 (1), 09921062 (1)		N0780437
2x00/4x00/5x00/7x00 DV Complete O-Ring Kit Includes: 09902045 (1), 09902131 (1), 09902223 (2), 09921061 (1), 09921062 (1)		N0770437
4300V/5300V/7300V Complete O-Ring Kit		N0770916
2x00/4x00/5x00/7x00 DV/8x00 (Viton)	1.171 i.d., 0.139 w.d.	09902131
2x00/4x00/5x00/7x00 DV/8x00 (Viton)	0.799 i.d., 0.103 w.d.	09902223
2x00/4x00/5x00/7x00 DV/8x00	1.109 i.d., 0.139 w.d.	09921061
2x00/4x00/5x00/7x00 DV/8x00	1.046 i.d., 0.139 w.d.	09921062
2x00/4x00/5x00/7x00 DV/8x00	0.801 i.d., 0.070 w.d.	09902045
4300V/5300V/7300V (For Ball Joint)	0.301 i.d., 0.070 w.d.	09926070
3x00 XL/3x00 DV/3000 SCX	0.239 i.d., 0.070 w.d.	09902006
3x00 XL/3x00 DV/3000 SCX	0.364 i.d., 0.070 w.d.	09902015
3x00 XL/3x00 DV/3000 SCX	8.74 i.d., 1.78 w.d.	09921028
3x00 XL/3x00 DV/3000 SCX/4300V/5300V/7300V (Inside)	0.239 i.d., 0.070 w.d.	09902207
3x00 XL/3x00 DV/3000 SCX/4300V/5300V/7300V (Outside)	0.301 i.d., 0.070 w.d.	09902247
All, O-Ring Lube 2 grams		09200078

Copper Ignitor Tape

ICP Model	Qty.	Part No.
8x00	50	N0781097*
2x00/4x00/5x00/7x00	120	N0775297

*Ignitor tape for Quartz and HybridXLT Torch.



EXPECT MORE FROM YOUR TORCH

ONLY FROM PERKINELMER!

Ceramic Quartz Torch

PerkinElmer's HybridXLT™ torch is the latest addition to the family of PerkinElmer genuine sample introduction components. The new ceramic/quartz hybrid design provides the highest performance for your Optima® ICP-OES 8x00 spectrometer. Available only from PerkinElmer, this new torch has an extended lifetime of up to 10x your current quartz torch, increasing instrument uptime and decreasing maintenance costs.



Features and Benefits

- Extended Torch Lifetime – up to 10x improvement
- Viewable plasma compared to a full ceramic design
- Ideal for all sample types, except organic solvents
- Increased instrument uptime
- Lower cost per analysis
- Exclusive patented design
- Lower cost than full ceramic torches

ICP Model	Number of slots	Part No.
8x00	1	N0780128

Ceramic D-Torch™

The ceramic outer tube is of particular benefit for the analysis of wear metals in engine oils, where quartz outer tubes often suffer from short lifetime. It is also beneficial for Si determinations, where quartz outer tubes may produce high background signals.



D-Torch

Part No. N0777840

Ceramic Outer Tube

Part No. N0777880

Features and Benefits

- Analysis of high-matrix solutions (i.e. fusion samples, samples with high- dissolved solids, samples with high-acid content) which can cause early devitrification or sample deposition when using quartz

Ceramic D-Torch™ and Replacement Parts

	ICP Model	Description	Part No.
	8x00	D-Torch Assembly including Quartz Outer Tube	N0777840
	8x00	Ceramic Outer Tube (optional)	N0777880
	8x00	Base and Inner Tube	N0777841
	8x00	Quartz Outer Tube	N0777842
	2x00/4x00/5x00/7x00*	DV D-Torch Quartz including Outer Tube	N0777508
	2x00/4x00/5x00/7x00	DV Base and Inner Tube	N0777509
	2x00/4x00/5x00/7x00	DV Quartz Outer Tube	N0777510
	4300/5300/7300V	D-Torch with Quartz Outer Tube	N0777051
	4300/5300/7300V	Quartz Outer Tube	N0777053
	4300/5300/7300V	Ceramic Outer Tube	N0777052
	4300/5300/7300V	Base and Inner Tube	N0777054
		Retaining Ring for Outer Tube	N0777055
		Copper Tape for D-Torch Outer Tube	N0777843
	2x00/4x00/5x00/7x00/8x00	O-Ring Kit	N0777715
	4300/5300/7300V	Torch Adapter with Auxiliary Port	N0774070

*Ceramic outer tube is not available for this model.

FULL SELECTION OF INJECTORS AND ADAPTERS



ALUMINA INJECTORS

Alumina injectors are corrosion-resistant to all mineral acids including HF and aqua regia. They are also used with less volatile organic solvents, e.g., xylene. The 2.0 mm i.d. Alumina injector is shipped standard with all PerkinElmer ICP-OES instruments. A variety of sizes are available as an alternative to the standard injector.

Alumina Injectors

ICP Model	Dimensions	Part No.
8x00	0.80 mm i.d.	N0781009
8x00	1.2 mm i.d.	N0781015
8x00 (1.2 mm entire length of tube)	1.2 mm i.d.	N0781007
8x00	2.0 mm i.d.	N0781014
2x00/4x00/5x00/7x00 DV	0.80 mm i.d.	N0775227
2x00/4x00/5x00/7x00 DV	1.2 mm i.d.	N0775228
2x00/4x00/5x00/7x00 DV (1.2 mm entire length of tube)	1.2 mm i.d.	N0776093
2x00/4x00/5x00/7x00 DV	2.0 mm i.d.	N0775177
4300V/5300V/7300V	1.2 mm i.d.	N0771531
3000/3000 SCR/3x00 RL	0.85 mm i.d.	N0582186
3000/3000 SCR/3x00 RL	1.5 mm i.d.	N0582185
3000/3000 SCR/3x00 RL	2.0 mm i.d.	N0582184
3x00 XL/3x00 DV/ 3000 SCX/4300V/5300V/7300V	2.0 mm i.d.	N0695362



Sapphire Injectors

Features and Benefits

- Sapphire injectors are ideal for silicon applications

ICP Model	Dimensions	Part No.
8x00	2.0 mm i.d.	N0781008
2x00/4x00/5x00/7x00 DV Sapphire in PFA base, (connects directly to ESI spray chambers)	1.8 mm i.d.	N0777044
2x00/4x00/5x00/7x00 DV	2.0 mm i.d.	N0775247
3000/3000 SCR/3x00 RL	2.0 mm i.d.	N0695495
3x00 XL/3x00 DV 3000 SCX/4300V/5300V/7300V	2.0 mm i.d.	N0695494



Quartz Injectors

Features and Benefits

- Quartz injectors are designed for organic solvents and non-HF matrices

ICP Model	Dimensions	Part No.
8x00	0.80 mm i.d.	N0781018
8x00	1.2 mm i.d.	N0781019
8x00 (1.2 mm entire length of tube)	1.2 mm i.d.	N0781013
8x00	1.6 mm i.d.	N0781016
8x00	2.0 mm i.d.	N0781050
8x00	3.0 mm i.d.	N0781017
2x00/4x00/5x00/7x00 DV	0.80 mm i.d.	N0775225
2x00/4x00/5x00/7x00 DV	1.2 mm i.d.	N0775226
2x00/4x00/5x00/7x00 DV	1.6 mm i.d.	N0775223
2x00/4x00/5x00/7x00 DV	2.0 mm i.d.	N0775014
2x00/4x00/5x00/7x00 DV	3.0 mm i.d.	N0775224
3x00 XL/3x00 DV/ 3000 SCX/4300V/5300V/7300V	0.8 mm i.d.	N0695461
3x00 XL/3x00 DV/ 3000 SCX/4300V/5300V/7300V	1.2 mm i.d.	N0695460
3x00 XL/3x00 DV/ 3000 SCX/4300V/5300V/7300V	1.6 mm i.d.	N0695449
3x00 XL/3x00 DV/ 3000 SCX/4300V/5300V/7300V	2.0 mm i.d.	N0695442

Injector Support Adapters

ICP Model	Spray Chamber	Part No.
2x00/4x00/5x00/7x00 DV 8x00	All	N0770603
2x00/4x00/5x00/7x00 DV 8x00*	All	N0776091
4300V/5300V/7300V (bottom)	Cyclonic	N0771526
4300V/5300V/7300V (top)	Cyclonic	N0771527

*For 1.2 mm entire length injectors N0776093 and N0781007

Injector Support Adapter O-Ring Kits

ICP Model	Part No.
2x00/4x00/5x00/7x00 DV/8x00	N0770438
3000/3000 SCR/3x00 RL	N0690269
3x00 XL/3x00 DV/3000 SCX	N0690769

ESI Injectors for Optima 8x00

Description	Part No.
1.5 mm Sapphire injector	N0782004
1.8 mm Sapphire injector	N0782005
1.8 mm Sapphire injector for Optima 8000 Series with adapter for 7x00	N0782006
1 mm Quartz injector	N0782007
1.5 mm Quartz injector	N0782008
2 mm Quartz injector	N0782009
2.5 mm Quartz injector	N0782010



GENUINE SAMPLE INTRODUCTION SUPPLIES

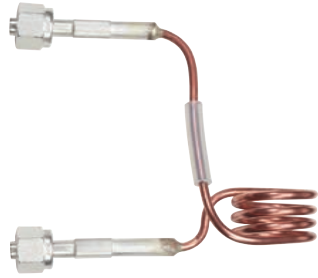

RF LOAD COILS*

ICP Model	Part No.
2x00/4x00/5x00/7x00 DV	N0775300
4300V/5300V/7300V	N0771536
3x00 XL/3x00 DV	N0690772
3000/3000 SCR/3x00 RL (For instruments manufactured AFTER 9/21/94)	N0690668

* Installation by PerkinElmer Service is required, but not included.

RF Load Coil Accessories

Description	Part No.
Igniter Spark Gap Assembly for Type II Demountable Torch	N0680275
Nylon Igniter Standoff	09989859

Purge Component Replacement Parts

For 5x00/7100/7200/7300 DV/8300

Description	Part No.
O-Ring (for Dual View Radial Purge Tube)	09200064
O-Ring (for Dual View Axial Purge Window)	09902143
O-Ring (for Torch Clamp on Vertical Torch Module)	09902155
DV Axial Window Cap	N0773084
DV Axial Window Holder	N0773090

For Optima 2100/7000/8000

Description	Part No.
O-Ring (for Dual View Radial Purge Tube)	09921036
O-Ring (for Dual View Axial Purge Window)	09921062
Purge Outlet O-Ring	09921057

Radial Window
Part No. N0581497

Axial Window
Part No. 09992731



Purge Extension Windows

The Axial View Purge Extension Window is a replaceable quartz window that slides into the purge extension between the torch and the optics. The Radial View Purge Extension Window Tube is a replaceable quartz tube that slides into the mount between the torch and the optics for the radial view.

ICP Model	View	Part No.
2x00/7000/8000	DV Axial	09992731
2x00/7000/8000	DV Radial	N0690672
2X00 (long tube)	Radial	B0810377
3x00/4x00/5x00/7100/ 7200/7300 DV/8300	DV Axial	N0771116
5x00/7100/ 7200/7300 DV/8300	DV Radial	N0770944
3x00 DV (tube)	DV Axial	N0691678
3x00 DV (long tube) (38 mm/1.5 in)	DV Radial	N0691689
3000 SCX/3x00 XL	Axial	09992731
3000/3000 SCR/3x00 RL 4300V/5300V/7300V	Radial	N0581497
4x00 DV/5x00 DV**	DV Radial	N0770322

** Pre November 2004



Ceramic Purge Extension

ICP Model	Part No.
3000/3000 SCR/ 3x00 RL/4300V/5300V/7300V	N0581455

Ceramic Interface Cone

The Ceramic Interface Cone includes the Ceramic Cone, the Purge Window (09992731) and the Clamp. The Ceramic Cone is used between the plasma and the spectrometer.

ICP Model	Part No.
3x00 XL/3000 SCX	N0690666

QUIET AND OIL-FREE

ICP-OES OIL-LESS AIR COMPRESSORS

PerkinElmer is expanding its product portfolio to include an industrial grade quiet oil-less compressor for dependable, clean and dry air supply. Each compressor comes assembled on an internally and externally coated air tank and includes optional self-purging regenerative air dryer with aftercooler and 5 micron particle filters. One version includes a silencing cabinet resulting in a compressor operating at a very quiet noise level of less than 60dB. All models are equipped with ASME rated pressure tanks and safety valves, line pressure regulator, gauges, and line ball valve for a complete turn key compressor station.



Specifications		
Horse Power		1.5 HP
Output CFM/Output L.		6.0 CFM/170 L/min
Max Pressure PSI/Max Pressure Bar		120 PSI/8 bar
Noise Level		72 dB/A, with Enclosure 55 dB/A
Tank Size Gal./Tank Size L		13 Gallons/50 Liters
Dimensions	without Enclosure with Enclosure	25" x 18" x 29" 29" x 23" x 32"
Weight	without Enclosure with Enclosure	97 Lbs. 207 Lbs.
Packed Dimensions	without Enclosure with Enclosure	28" x 21" x 29" 33" x 28" x 39"

Compressors

Description	115V/60Hz	220V/50Hz	220V/60Hz
Air Compressor	N0777881	N0777882	N0777883
Air Compressor with Dryer	N0777602	N0777603	N0777604
Air Compressor with Dryer in Silencing Cabinet	N0777605	N0777606	N0777607

Product meets both U.S. and Canadian CSA standards. ASME® certified tank.
Please note: Silencing cabinet cannot be sold separately.

Replacement parts

Description	Part No.
Replacement Air Intake Filter	N0777608
Micron Dryer Filter Element	N0777609
Replacement Piston Assembly	N0777610
Replacement Reed Valve	N0777611
Replacement Head Gasket	N0777612



INSTRUMENT BENCHES AND ACCESSORY CARTS



Optima
Advanced Bench



Optima
Basic Bench



NexION Bench with
Optional Monitor Arm

A CUSTOMIZED APPROACH

Lab space is precious and it can be a challenge to find room for a new instrument or accessory. To make the transition easier, we've customized every bench we offer for your instrument and accessory configuration, enabling you to use your lab space to its full potential. Whether you're making room for a new instrument or replacing an old system, we have a bench solution for you.

Ordering Information

Dimensions (Depth x Width x Height)	Description	Product Line	Part No.
30" x 60" x 34"	PinAAcle Bench	AA	N0777783
30" x 60" x 35"	Optima Basic Bench	ICP-OES	N0773106
33" x 21"	Large Shelf for Optima Basic Bench (Shelf Only)	ICP-OES	N0777930
30" x 60" x 35"	Optima Advanced Bench	ICP-OES	N0771725
30" x 60" x 29"	NexION Bench with Vacuum Pump Dolly	ICP-MS	N8141230
	NexION Vacuum Pump Dolly Only	ICP-MS	N8121069
26"	Monitor Arm for Optima Advanced or NexION Bench	ICP-OES/ICP-MS	N0771726
32" x 30" x 29"	Titan MPS Bench	AA/ICP-OES/ICP-MS	N0777900
16" x 19" x 34"	Accessory Cart	Various	N0777784
16" x 22" x 34"	Accessory Cart	Various	N0777785



Meinhard Nebulizers

The MEINHARD® Concentric Nebulizer reflects exacting standards in design and manufacturing. Its advantages include simplicity of design and operation, reproducible and self-aligning aerosol, and close fabrication control. They provide excellent sensitivity and precision for aqueous solutions and samples with few dissolved solids (less than 1%). MEINHARD® Nebulizers are self-aspirating and not to be used with solutions containing hydrofluoric acid. Nebulizers require an end cap (N0680504) for use with Scott Spray Chambers.

Type	Material	AR Flow Rate	Uptake Rate	Part No.
Type C3	Glass	1.0 L/min	3 mL/min	N8102011
Type K3	Glass	1.0 L/min	3 mL/min	N0681574
Type A3	Quartz	1.0 L/min	3 mL/min	WE024371
Type A0.5 (NexION)	Quartz	1.0 L/min	0.5 mL/min	N8145011
Type C0.5 (NexION)	Glass	1.0 L/min	0.5 mL/min	N8145012

*Liquid Connector WE024372 not included with Meinhard nebulizers.

MEINHARD® Plus Nebulizers

MEINHARD® Plus Nebulizers provide low dead volume and high sensitivity with excellent detection limits and washout. Each Plus nebulizer includes the FitKit+ gas and sample quick connect fittings. The connections are made with high-purity PFA, minimizing the chance of contamination during backflow events. The gas connection fits snugly over the maria on the sidearm of the nebulizer.



Description	Material	AR Flow Rate	Uptake Rate	Part No.
SilQ+ Ultra-high Purity	Quartz	1.0 L/min	0.5 mL/min	N8122460
TQ+ High Sensitivity	Quartz	1.0 L/min	0.5 mL/min	N8122461
TQ+ High Sensitivity	Quartz	1.0 L/min (30 psi)	0.5 mL/min	N8142098
TR+ High Sensitivity	Glass	1.0 L/min	0.5 mL/min	N8122462

*Includes FG Gas Quick Connect (N8121036) and F2 Quick Connect (N8121039) with 0.5 mm i.d. (orange marker) capillary, 70 cm.











Liquid Connector

Low dead volume PEEK connector for use with MEINHARD® Concentric Nebulizers. Requires 0.062 in (1.59 mm) o.d. tubing (WE024375). Standard on ELAN DRCs. Not required for PFA PTFE Nebulizers.



ICP-MS Model	Part No.
ELAN (solution fitting, 0.7 mm ETFE)	WE024372
NexION (solution fitting, 0.5 mm PTFE)	N8145016

Connectors and Nebulizer Spares

Description	Part No.
 Nebulizer Clip for Meinhard Nebulizers	N0777460
 Nebulizer Liquid Connector Kit 4 mm (solution fitting, 0.5 mm PTFE with adapter) (NexION)	N8145016
 PFA FG Gas Quick Connect	N8121036
 F2 Standard Integrated Capillary (0.5 mm i.d. orange 70 cm long)	N8121039
 F0 Encapsulated Micro Tubing (0.25 mm i.d. green 70 cm long)	N8121038
 F1 Detachable Capillary (0.80 mm i.d. blue 70 cm long)	N8121037
 Spray Chamber Drain Fitting	N8145015
 Male Barb CTFE Fitting (Part of N8145016)	N8145017
 Female Barb CTFE Fitting (Part of N8145016)	N8145018
 PTFE Sample Capillary 0.062 o.d. x 0.020 i.d.	WE024375
 Liquid-End Nebulizer Connector (ELAN)	WE024372

End Cap for Concentric Nebulizers

End cap to fit any concentric nebulizer onto a Scott Spray Chamber.



Description	Part No.
End Cap for Concentric Nebulizers	N0680504

GemClean Cross-Flow II Nebulizer

Complete chemically inert Cross-Flow II nebulizer assembly for ICP-MS. Specially processed to reduce BEC levels below 1 ppb. Contains an end cap with a GemTip clear sapphire sample tip and a GemTip red ruby argon tip optimized for ICP-MS.



Description	Part No.
GemClean Cross-Flow II Nebulizer	N8120516

Cross-Flow Replacement GemTips and Spares

Includes a clear sapphire sample tip and a red ruby argon tip optimized for ICP-MS. The tips are constructed of PEEK for maximum corrosion resistance. Used in all GemClean Cross-Flow II nebulizers produced after September, 1998.



Description	Part No.
Cross-Flow II Replacement GemTips	N8120515
Cross-Flow II Nebulizer Argon Ferrule	09920515
Cross-Flow II Nebulizer Ferrule Kit*	N0680612
Cross-Flow II Nebulizer End Cap	N8122239
Cross-Flow II Nebulizer Sample Ferrule	09920518
GemTip II O-Ring	09921045
End Cap O-Ring	09902033
Sample Tubing	09985708
Argon Tubing	09985723

*Includes 09920515 and 09920518.

MicroMist Nebulizers

The MicroMist micro-uptake glass concentric nebulizer offers high performance for limited sample volumes. MicroMists with sample uptakes 0.2 – 0.4 mL/min are fitted with a UniFit connector with 1.3 o.d. x 0.50 mm i.d. x 700 mm long sample tubing. MicroMists with sample uptakes 0.05 – 0.1 mL/min are fitted with a UniFit connector with 1.3 o.d. x 0.25 mm i.d. x 700 mm long sample tubing. All MicroMist nebulizers glass are supplied with the EzyLok argon connector.

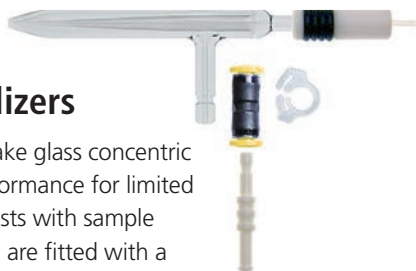

AR Flow Rate	Uptake Rate	Part No.
1.0 L/min	0.4 mL/min	N0775341
1.0 L/min	0.2 mL/min	N0775342
1.0 L/min	0.1 mL/min	N0775343
1.0 L/min	0.05 mL/min	N0775344

SeaSpray Nebulizers

The SeaSpray Concentric Nebulizer is ideal for samples with high dissolved solids and offers outstanding nebulization efficiency for trace level analysis. It offers freedom from clogging while nebulizing solutions near the limit of solubility of most mineral salts, and conferring significant sensitivity gains. All SeaSpray Nebulizers are supplied with the EzyLok Argon connector.



AR Flow Rate	Uptake Rate	Part No.
1.0 L/min	2 mL/min	N0775340
1.0 L/min	1 mL/min	N0774069
1.0 L/min Quartz	1 mL/min	N0774069
1.0 L/min	0.4mL/min	N077484

DuraMist Nebulizers

The DuraMist concentric nebulizer is an economical nebulizer for high precision analyses involving samples digested in HF. The DuraMist nebulizer is recommended for samples containing up to 5% HF. For samples with higher concentrations of HF, the OpalMist PFA nebulizer is recommended.



AR Flow Rate	Uptake Rate	Part No.
1.0 L/min	0.4 mL/min	N8121046
1.0 L/min	1.0 mL/min	N8121045

Connectors for MicroMist and SeaSpray Nebulizers



Description	Pkg.	Part No.
UniFit		
0.25 mm ID x 1.27 mm OD x 700 mm long	10	N0777514
0.50 mm ID x 1.27 mm OD x 700 mm long	10	N0777513
0.75 mm ID x 1.27 mm OD x 700 mm long	10	N0777512
1.30 mm OD X 0.75 mm ID x 700 mm long	3	N0774077
1/16 inch OD X 0.75 mm ID x 700 mm long	3	N0774080
UniFit-EzyFit Sample Tube	6	N0777061
EzyFit		
0.25 mm ID x 1.27 mm OD x 700 mm long	10	N0777437
0.50 mm ID x 1.27 mm OD x 700 mm long	10	N0777436
0.75 mm ID x 1.27 mm OD x 700 mm long	10	N0777435
0.25 mm ID x 1/16" OD x 700 mm long	10	N0777464
0.50 mm ID x 1/16" OD x 700 mm long	10	N0777463
0.50 mm ID x 1/16" OD x 700 mm long Twin	6	N0777462
1/16 inch OD x 0.25mm ID x 700mm	10	N0777845
1/16 inch OD x 0.50mm ID x 700mm	10	N0777846
1/16 inch OD x 0.75mm ID x 700mm	10	N0777847
UniFit-EzyFit Sample Tube	6	N0777061

OpalMist Nebulizers

The OpalMist is ideal for the geochemistry & semiconductor industry. The OpalMist PFA concentric nebulizer is for high precision analyses involving analyses requiring high chemical resistancy to HF, alkalis and organics. It also provides excellent results for trace analyses.



AR Flow Rate	Uptake Rate	Part No.
1.0 L/min	0.4 mL/min	N0777485
1.0 L/min	0.1 mL/min	N0777486
1.0 L/min	0.2 mL/min	N8121056
1.0 L/min	0.05 mL/min	N8121057
1.0 L/min	2 mL/min	N8121061

The Eluo™ Nebulizer Cleaner

The Eluo is designated to efficiently deliver a cleanser through the nebulizer capillary to dislodge particle build-up and thoroughly clean the nebulizer. One simple action does it all. No more messy procedures, waiting overnight or shattered nebulizers in ultrasonic baths.



Description	Part No.
For Newer OpalMist, PolyCon, DuraMist, Meinhard, other Glass Nebulizers.	N0777712
For OLD style OpalMist or PolyCon Nebulizers.	N0775358

HIGH EFFICIENCY MICROFLOW NEBULIZERS

MicroFlow nebulizers are constructed entirely from chemically resistant fluoropolymers, ideal for strong acids, alkalis, organics, high salt solutions and high solid concentrations. They are resistant to clogging, are reliably self-aspirated or pumped and produce a fine aerosol for high transport efficiency and high sensitivity.

PFA-ST Nebulizer

The PFA-ST nebulizer features high purity, HF-resistance, and high performance, along with an exchangeable external sample uptake capillary. The sample uptake rate is controlled by the dimension of the external capillary or probe. For use with autosamplers. Requires a CTFE union (N8122355) to connect to the UltraClean autosampler probe. All-PTFE construction, chemically inert. Chemically resistant—ideal for strong acids, alkalis, organics. Resistant to clogging – reliably self-aspirated or pumped. Low, spike-free background for important elements such as:



- Fe and Ca. Produces a fine aerosol for high transport efficiency and high sensitivity
- Analyze all sample types with a single introduction system
Direct analysis of volatile and non-volatile organic solvents

Description	Part No.
PFA-ST Nebulizer	N8122192

PolyPro-ST Nebulizer

The PolyPro-ST Nebulizer is an HF resistant alternative to the PFA nebulizer. The PolyPro has lower chemical resistance than the PFA nebulizer but has the same high efficiency aerosol generation. A robust nebulizer that can self aspirate with an exchangeable external sample uptake capillary or used with a peristaltic pump.

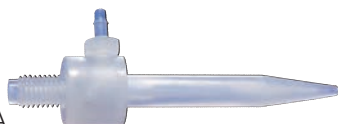

Description	Part No.
PolyPro-ST Nebulizer	N0777220

PFA-ST3 Nebulizer

Designed for superior clog resistance and higher sensitivity. PFA-ST3 nebulizer with external threaded connector is a high performance, clog resistant and chemically inert nebulizer for ICP-MS.



Description	Part No.
PFA-ST3 Nebulizer	N8145101



PFA Nebulizer Obstruction Removal Kit

Obstruction Removal Kit while naturally resistant to obstructions, PFA nebulizers may occasionally require maintenance. Use this kit to safely remove obstructions in all PFA-ST nebulizers for long-term high performance.

Description	Part No.
Nebulizer Obstruction Removal Kit	N8145236

PTFE Sample Capillaries

For use with ST Nebulizers.

I.D.	Self-Aspiration Rate	Part No.
0.15 mm Red	20 µL/min	N8122382
0.2 mm Purple	50 µL/min	N8145135
0.25 mm Green	100 µL/min	N8122383
0.3 mm Yellow	200 µL/min	N8145136
0.5 mm Orange	400 µL/min	N8122384
0.8 mm Blue	700 µL/min	N8145137
1.0 mm Gray	1 mL/min	N8145138

Sample Introduction Kits for NexION

Complete high purity sample introduction system for NexION. All wetted surfaces are PTFE and Pt.



Used by a majority of semiconductor labs worldwide for the analysis of semiconductor grade chemicals and Si wafer samples. Includes 2 PFA MicroFlow Nebulizers, PureCap PFA endcap with additional gas port, PFA spray chamber, Pt injector, Pt Shield and quartz torch.

Description	Part No.
PFA-Platinum HF-Resistant Sample Introduction Kit	N8142001

Complete HF-resistant sample introduction system for NexION. All wetted surfaces are PTFE and Sapphire. Provides a chemically inert and clean introduction system. Includes a PFA-ST Nebulizer, PureCap PFA endcap with additional gas port, PFA spray chamber, Sapphire injector, Pt Shield and quartz torch.

Description	Part No.
PFA-Sapphire HF-Resistant Sample Introduction Kit	N8142002
HF Sample Introduction Kit Consists of a Scott spray chamber with a Cross-Flow II nebulizer, a 2 mm alumina injector, injector support adapter, O-rings, tubing and connectors.	N8140507

Cyclonic Spray Chambers

- The Cyclonic Spray Chamber relies on momentum to efficiently and quickly remove the larger droplets from the sample mist decreasing any opportunity for occlusion or agglomeration of the smaller droplets. The result is higher efficiency, better precision and faster washouts than other spray chamber designs
- Decreased sample introduction system installation and optimization time due to the preset nature of the spray chamber/nebulizer combination
- More samples per hour due to minimal dead volume and efficient draining

Unique design characteristics:

- The nebulizer port is oversized so that sample solution cannot build up around the nebulizer as it will in other cyclonic designs
- The nebulizer port angle is tightly controlled so that the nebulizer mist impacts on the same chamber wall area in each and every spray chamber
- Each spray chamber incorporates a precisely machined ridge a long the inside top of the spray chamber. This eliminates the periodic “spiking” that adversely affects precision and fosters faster washout times

Baffled Cyclonic Spray Chambers

The spray chamber is an integral part of the sample introduction system responsible for filtering the sample mist to permit the appropriate droplet size distribution to reach the plasma. The baffled cyclonic spray chamber features a central transfer tube which acts as a secondary particle separator helping separate larger aerosol particles from the sample. This reduces solvent load in the plasma without compromising detection limits. The distance between the bottom of the baffle and the chamber wall is carefully controlled so that droplets cannot form on the bottom of the baffle. The advantage is smooth draining and improved precision.



Part No. WE025221

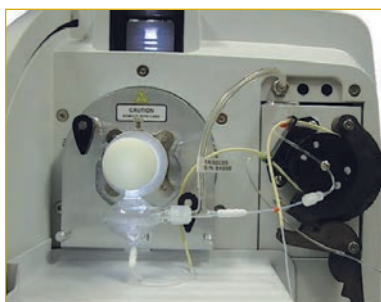

Baffled Quartz Cyclonic Spray Chambers

Baffled Quartz Spray Chamber (PTFE O-Ring type) with ball joint.



Part No. N8145013

ICP-MS Model	Part No.
NexION*	N8145013
ELAN DRC/DRCplus/DRC II	WE025221
O-Ring for Baffled Quartz Cyclonic Spray Chamber	09210011

*O-Ring free

Baffled Glass Cyclonic Spray Chambers

The Cyclonic Spray Chamber relies on momentum to efficiently and quickly remove the larger droplets from the sample mist decreasing any opportunity for occlusion or agglomeration of the smaller droplets. The result is higher efficiency, better precision and faster washouts than other spray chamber designs. For use with ball joint injectors.



Part No. N8145014

ICP-MS Model	Part No.
NexION (Standard with NexION Q/X/D)**	N8145014
ELAN	N0773196

**O-Ring free



Part No. N0777034

ELAN Baffled Quartz Cyclonic PC³ Spray Chambers

7 mm baffle, aux. gas port, drain line included and connects directly to ESI injectors. An adapter is needed to connect to other injectors. All-purpose for non-HF samples. Provides excellent sensitivity and stability with low background. For use with PC³.

Description	Part No.
With Auxillary Gas Port	N0777034
Without Auxillary Gas Port	N0777035

SPRAY CHAMBERS



Part No. N8122188

Part No. N0775350

Glass Cyclonic Spray Chamber Kit

Contains one Glass Cyclonic Spray Chamber, mounting hardware and instructions. Requires, but does not include, a concentric nebulizer.

Description	Part No.
For ELAN 9000/6x00/5x00/DRC-e	
Glass Cyclonic Spray Chamber Kit	N8120150
Glass Cyclonic Spray Chamber Only	N8122188
O-Ring Free Glass Cyclonic Spray Chamber	N0775350

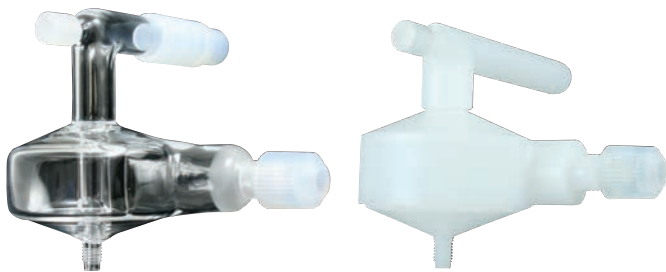

Part No. N8145120

Part No. N8145122

NexION O-Ring Free Baffled Cyclonic PC³ Spray Chambers

Feature o-ring free connections to the nebulizer and torch injector, secure, leak-free threaded drain port, internal baffle and threaded auxiliary port for addition gas.

Description	Part No.
High Purity Quartz Cyclonic Spray Chamber provides excellent sensitivity and stability with low background	N8145120
Micro Cyclonic Spray Chamber provides the fastest washout at low-flow rates compared to larger versions	N8145121
Borosilicate Glass Spray Chamber	N8145119
PFA Cyclonic Spray Chamber	N8145122

Connectors and Spares



Part No. N8141420

Part No. N0777438

Part No. N0777439

Description	Pkg.	Part No.
Helix Locking Screw	1	N0777438
Helix Seal	4	N0777439
PFA 6 mm Short Length Secure Replacement Nut for Quartz Cyclonic Spray Chambers	1	N8141420
PFA 6 mm Long Length Secure Replacement Nut for Quartz Cyclonic Spray Chambers	1	N8145321



Part No. N8120124

Scott Spray Chambers

Complete HF-resistant Scott Spray Chamber Includes (1) large O-Ring (WE013060), (1) Retaining Ring (WE014081) and (1) Right-Angled Drain Connector (WE013119).

Description	Part No.
For NexION/ELAN 9000/6x00/5000/DRC-e	
Scott Spray Chamber	N8120124
Scott Spray Chamber Large O-Ring	WE013060
Scott Spray Chamber Retaining Ring	WE014081
End-cap for Concentric Nebulizer. Ryton endcap to fit nebulizer onto Scott Spray Chamber	N0680504



Part No. N8142000

PFA PTFE Scott Spray Chamber

UltraClean, low volume 47 mm Scott Spray Chamber. For use with concentric nebulizers. Requires a PFA injector assembly and the PFA End Cap (N8122357).

Description	Part No.
PFA PTFE Scott Spray Chamber	N8122356
PFA Spray Chamber with PFA End Cap for NexION*	N8142000

* Requires PFA body injector N8122411 or N8122412 or N8122413.



Part No. N8145099



Part No. N8142003

PC³ Peltier Coolers for NexION

The PC³ is a small and robust Peltier cooler for ICP-MS cyclonic spray chambers. The cyclonic spray chamber offers the advantages of low memory effects, fast rinseout and high sample transport efficiency. The PC³ cools the outer walls of the cyclonic spray chamber to a constant temperature, enhancing long-term signal stability, reducing polyatomic interferences such as oxides, and reducing solvent loading when volatile organic solvents are analyzed. The PC³ has 2 preset temperatures +2 °C / -5 °C and is ideal for analysis of aqueous or aqueous/organic mixtures. The PC³-LT operates at -20 °C to reduce the solvent load on the plasma for analysis of 100% volatile organic solvents.

Description	Injector Size	Temperature	Additional Gas Port	Part No.
PC ³ Sample Introduction Kit*	1.5 mm	+2 °C / -5 °C	Yes	N8142003
HF PC ³ Sample Introduction Kit*	1.5 mm	+2 °C / -5 °C	Yes	N8145309
PC ³ -LT Organic Sample Introduction Kit*	1.0 mm	+2 °C / -20 °C	Yes	N8145099
HF PC ³ -LT Organic Sample Introduction Kit*	1.5 mm	+2 °C / -20 °C	Yes	N8145310

* All PC³ kits include a PFA-ST nebulizer (N8122192).

PC^{3x} Peltier Controlled Heated or Cooled Cyclonic Chamber for NexION



The PC^{3x} is a compact Peltier heated or cooled inlet system that controls the spray chamber temperature and improves long-term stability. In cooling mode, water or solvent is removed from the aerosol, reducing water or solvent loading on the plasma. In heating mode, sensitivity is increased and volatility-related sample transport effects can be reduced or eliminated.

- Variable temperature control from -10 °C to +80 °C
- Thermal stabilization of spray chamber improves long-term stability
- Last set temperature saved for stand alone operation
- USB or Bluetooth connectivity
- Remote monitoring and control

Description	Part No.
PC ^{3x} thermally stabilized inlet system	N8145340

PC³ Peltier Coolers for ELAN

The PC³ is a small and robust Peltier cooler for ICP-MS cyclonic spray chambers. The cyclonic spray chamber offers the advantages of low memory effects, fast rinse-out and high sample transport efficiency. The PC³ cools the outer walls of the cyclonic spray chamber to a constant temperature, enhancing long-term signal stability, reducing polyatomic interferences such as oxides, and reducing solvent loading when volatile organic solvents are analyzed. The PC³ has two preset temperatures +2 °C / -5 °C and is ideal for analysis of aqueous or aqueous/organic mixtures. The PC³-LT operates at +2 °C / -20 °C to reduce the solvent load on the plasma for analysis of 100% volatile organic solvents.



ICP-MS Model	Part No.
ELAN Cassette Torch Mount	N8122410
ELAN Twist Type Torch Mount	N8122389
ELAN PC ³ -LT	N8122452



IsoMist Programmable Temperature Spray Chambers

The IsoMist Programmable Temperature Spray Chamber lets you select any temperature between -10 °C and +60 °C in 1 °C increments to provide the optimum conditions for any application. The rapid response of the Peltier device allows a spray chamber temperature of -5 °C to be reached within 15 minutes. The spray chamber temperature can be monitored through a temperature versus time plot on your PC screen. And, for regulatory compliance, the temperature versus time data file can be saved with your results. If these features are not required, once the temperature has been programmed, the IsoMist can be run in stand-alone mode without a PC connection.

- Temperature range: -10 °C to +60 °C
- Temperature set in 1 °C increments
- Temperature stability: +/- 0.1 °C

ICP-MS Model	Part No.
ELAN	N0777364
NexION	N8141426

INJECTORS AND ADAPTERS



Alumina Injectors

Alumina injectors are compatible with twist type and cassette torch mounts. They are vacuum baked to reduce contamination.

Features and Benefits

- 2.0 mm i.d. for use with HF-resistant sample introduction system. Standard injector for aqueous solutions and less volatile organic solvents
- 0.85 mm i.d. for use with volatile organic solutions on the HF-resistant sample introduction system

Alumina Injectors for NexION/ELAN DRC-e/9000/6x00/5000/500

Dimension	Part No.
2.0 mm i.d.	N8126041
1.5 mm i.d.	N8126040
0.85 mm i.d.	N8126039

Quartz Injectors



Quartz Injectors are compatible with twist type and cassette torch mounts. The ELAN DRC II uses a specially designed all-quartz sample introduction system to minimize background contamination levels. The standard 2.0 mm i.d. quartz injector is held by a specially designed pass-through, injector support assembly to minimize contact with materials that could cause sample contamination, a must for determinations made at the parts-per-trillion level.

Quartz Injectors

For the NexION/ELAN DRC-e/9000/6x00/5000 when using the HF-Resistant Sample Introduction System (WE024782).

Description	Recommended Use	Part No.
1.2 mm i.d.	Organic Solvents	N0681631
1.6 mm i.d.	Organic Solvents	00473292
2.0 mm i.d.	Clinical Samples	N8125029

Quartz Ball Joint Injectors



For NexION/ELAN DRC/DRCplus/DRC II. For use with Pass-Through Ball Joint Injector Support Adapters (WE023951 or W1012406).

Description	Recommended Use	Part No.
0.85 mm i.d.*	Volatile Organics	WE027030
1.5 mm i.d.*	Organics	WE027005
2.0 mm i.d.	General Purpose	WE023948

*For reduced sample loading.

Sapphire Injectors



Sapphire Injector Tube, 2.0 mm i.d.

Demountable injector for use with the HF-resistant sample introduction system. Not for use with PFA sample introduction system.

Dimension	Part No.
NexION/ELAN DRC-e/9000/6x00/5000	N0695495

PFA Injector Assemblies

PFA/Quartz Torch Injector Assembly

Description	Dimension	Part No.
PFA/Quartz Twist Type	1.5 mm i.d.	N8122394
PFA/Quartz Cassette	1.5 mm i.d.	N8122413

PFA/Sapphire Torch Injector Assembly

Description	Dimension	Part No.
PFA/Sapphire Twist Type	1.8 mm i.d.	N8122358
PFA/Sapphire Cassette	1.8 mm i.d.	N8122411

PFA/Platinum Torch Injector Assembly

Description	Dimension	Part No.
PFA/Platinum Twist Type	2.0 mm i.d.	N8122359
PFA/Platinum Cassette	2.0 mm i.d.	N8122412

Injector Support Adapters



ICP-MS Model	Part No.
ELAN DRC/DRCplus/DRC II	
Ball Joint Twist Type Torch Injector Support Adapter	WE023951
ELAN DRC II	
Ball Joint Cassette Torch Injector Support Adapter	W1012406
ELAN 9000/6x00/5000/DRC-e	
Twist Type Torch Injector Support Adapter	N8122007
Twist Type Torch Injector Support Adapter (Assembled with O-Rings)	N8120116
NexION/ELAN 9000/6x00/5000/DRCs	
Injector Support Adapter O-Ring Kit	N8120100
Cassette Torch Injector Support Adapter For Non-Ball Joint Injectors	W1013266
Cassette Torch Injector Support Adapter For Ball Joint Injectors	W1012406

Injector Support Adapter O-Rings

Position	Torch Type	Part No.
Internal	Twist/Cassette	09210011
External (large)	Cassette	W1013545
External	Twist/Cassette	09210012
Internal	Cassette (non-Ball Joint only)	N8122010
Internal	Twist (non-Ball Joint)	WE013060

Injector Adapter Kits and O-Rings can be found on the next page.

Injector Adapter Kits and O-Rings

Description	Qty	Part No.
For NexION Injector Adapter Kit (Includes items listed below) N8140360		
Adapter	1	W1012406
O-Ring 3/8 inch i.d. x 1/16 inch	1	W1008572
O-Ring 1/4 inch i.d. x 1/16 inch	1	W1008573
Injector Spacer	1	W1012409
Injector Nut	1	W1012408
For NexION Injector Adapter Kit 2 (Includes items listed below) N8140527		
Injector O-Ring 0.239 i.d. x 0.070 WD	1	09210011
O-Ring 0.551 i.d. x 0.070 WD	1	N8122010
O-Ring 3/8 inch i.d. x 1/16 inch	1	W1008572
Adapter	1	W1012406
Injector Nut	1	W1012408
Injector Spacer	1	W1012409
O-Ring 5/8 inch i.d. x 1/8 inch WD	1	W1013545
For ELAN Cassette O-Ring Kit for Injector Support (Includes items listed below) N8120100		
Injector O-Ring 0.239 i.d. x 0.070 WD	2	09210011
Torch O-Ring 0.364 i.d. x 0.070 WD	2	09210012
O-Ring 0.551 i.d. x 0.070 WD	1	N8122010
O-Ring 5/8 inch i.d. x 1/8 inch WD	1	W1013545

Demountable Quartz Torch

The EasyGlide™ torch mount and alignment system used in the ELAN and NexION ICP-MS system. It is a demountable design that incorporates a quartz torch with a fully replaceable sample injector made of fused alumina, quartz or sapphire.



ICP-MS Model	Part No.
NexION/ELAN	N8122006

High Efficiency Demountable Quartz Torch

Demountable Quartz Torch only. Operates at 25% reduced argon gas flows compared to the Demountable Quartz Torch (N8122006). The ELAN 9000 and 6x00 require the High Efficiency Torch Kit (W1007468) for first time installation.



ICP-MS Model	Part No.
ELAN 9000/6x00/DRCs	W1008384
NexION	N8145318

High Efficiency Torch Kit

Includes the High Efficiency Torch (W1008384) and flow restrictors required for use with the ELAN 9000 and 6x00.

ICP-MS Model	Part No.
ELAN 9000 and 6x00	W1007468

O-Ring-Free Demountable Quartz Torch

Demountable quartz torch for o-ring-free injectors. Use with ESI o-ring-free injectors.

ICP-MS Model	Part No.
ELAN/NexION	N8145106



Ceramic D-Torch

Part No. N0777415

Part No. N0777419

The D-Torch is a revolutionary new demountable torch design. With the D-Torch, you need only replace the outer tube with interchangeable quartz and ceramic outer tubes.

Description	Part No.
D-Torch complete with Quartz Outer Tube	N0777419
D-Torch complete with Ceramic Outer Tube	N0777415
Base and Inner Tube	N0777416
Ceramic Outer Tube	N0777417
Quartz Outer Tube	N0777420
Retaining Ring	N0777055

Torch Alignment Tool

Used to align the torch in the load coil.

ICP-MS Model	Part No.
NexION/ELAN 9000/6x00/DRCs	WE015554

Cassette Torch Mount

The Cassette Torch Mount is an innovative torch design that is fully modular, demountable, rugged and easy to maintain.



ICP-MS Model	Part No.
NexION	W1037485
ELAN DRC II	W1020672
ELAN 9000/DRC-e	W1020668

Does not include Demountable Quartz Torch or Injector.

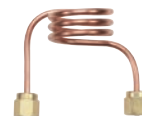

RF Load Coil Assemblies

ICP-MS Model	Part No.
NexION/ELAN 9000/6x00/DRCs	WE021816
ELAN 5000	WE012411

Power Amplifier Tube (Ceramic)

ICP-MS Model	Part No.
NexION/ELAN 9000/6x00/DRCs and ELAN 5000As manufactured after September, 1992	N0695477

NexION SimulScan Dual-Stage Detector

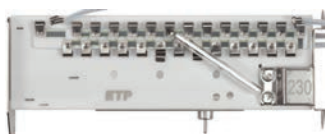

The dual-stage detector is an integral part of the NexION 300 ICP-MS SimulScan™ system. This electron multiplier measures both high- and low-level analytes simultaneously. This conserves valuable or limited samples, eliminates the need to perform time-consuming sample dilutions and allows you to quickly characterize unknown samples.

ICP-MS Model	Part No.
NexION*	N8145000

Original SimulScan Dual-Stage Detector



The original dual-stage detector is an integral part of the ELAN SimulScan™ system. This electron multiplier measures both high- and low-level analytes simultaneously. This conserves valuable or limited samples, eliminates the need to perform time-consuming sample dilutions and allows you to quickly characterize unknown samples.

ICP-MS Model	Part No.
ELAN 9000/6x00/DRCs* manufactured prior to April, 2005	N8125001

Improved SimulScan Dual-Stage Detector

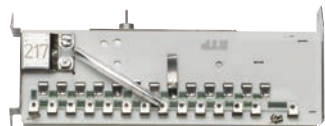

The improved Dual-Stage Detector is designed for better stability and longer lifetime than its predecessor. ELAN instruments produced after April, 2005 have the proper electronics to accept this detector without modification. ELAN instruments manufactured before April, 2005 will require a one-time upgrade to the Detector Electronics (W1013195). Using this detector in an instrument without the upgraded electronics will result in higher noise levels and shorter lifetime.

ICP-MS Model	Part No.
ELAN 9000/6x00/DRCs*	N8125050

Detector Electronics Upgrade Kit

Boosts detector life at least 20%.

ICP-MS Model	Part No.
ELAN 9000/6x00/DRCs* manufactured prior to April, 2005	W1013195

* Service installation is required, but not included.

Ion Optics

PerkinElmer offers the industry's only single-ion lens with the exclusive SwiftMount™ II cassette lens mount. No tools are required as the design incorporates a clean capture-and-release concept.

Ion Lens

Description	ICP-MS Model	Part No.
Cassette Ion Lens Upgrade Kit	ELANs manufactured before April, 2005	W1017871
Series II Ion Lens	ELAN 9000/6x00/DRCs manufactured after January, 1998	WE018034
Ion Lens	ELAN 6000s manufactured before January, 1998	WE014777
Series II Lens Removal Tool	ELAN 9000/6x00/DRCs manufactured between January, 1998 and April, 2005	W1010620

Series II Ion Lens



Series II ShadowStop

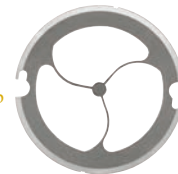

ShadowStop

Description	ICP-MS Model	Part No.
Cassette Lens ShadowStop	ELAN 9000/DRCs manufactured after April, 2005	W1013361
Series II ShadowStop	ELAN 9000/6X00/DRCs manufactured between January, 1998 and April, 2005	WE029011

Vacuum Pump Fluid for ELAN

For use with roughing pumps.

Pump Model	Part No.
Leybold	N8122004
Varian	N8122308

Fomblin (PFPE) Vacuum Pump Fluid

For use with NexION ICP-MS only. One liter Fomblin GV80 fluid (perfluoro polyether). 1L required per pump.

Description	Part No.
NexION Vacuum Pump Fluid	N8145003

High Vacuum Silicon Grease

For lubrication of vacuum system O-Rings.

Description	Part No.
High Vacuum Silicon Grease	09905147

TESTED AND APPROVED

Sampler and Skimmer Cones

Precision-designed and manufactured, large-orifice sampler and skimmer cones provide superior long-term stability and resist clogging, allowing analysis under both high and low sample-uptake conditions. Nickel is a very rugged, long-lasting material for the majority of sample types, while platinum is the material of choice for more corrosive samples. The ELAN sampler cone, with a 1.1 mm orifice diameter, and the skimmer cone, with a 0.9 mm orifice diameter, are the largest in the industry. They have been designed to maximize signal stability and to minimize clogging during extended runs of samples containing high dissolved solids. The sampler cone, which is continually exposed to the plasma and the sample, utilizes a threadless pop-in, pop-out design for rapid removal.



NexION Cones



ELAN Cones

Nickel Sampler and Skimmer Cones

ICP-MS Model	Type	Part No.
NexION	Sampler	W1033612
NexION	Skimmer	W1026356
ELAN 9000/6x00/DRC	Sampler	WE021140
ELAN 9000/6x00/DRC	Skimmer	WE021137

Platinum Sampler and Skimmer Cones*

ICP-MS Model	Type	Part No.
NexION	Sampler	W1033614
NexION	Skimmer	W1026907
ELAN 9000/6x00/DRC	Sampler	WE027802
ELAN 9000/6x00/DRC	Skimmer	WE027803

* Prices subject to change based on volatile precious metal prices.



Cone Removal Tool

ICP-MS Model	Part No.
NexION	W1034694
ELAN 9000/6x00/DRC	WE017142

Hyper Skimmer Cone and Spares



Description	ICP-MS Model	Part No.
Hyper Skimmer Cone	NexION	W1033995
Hyper Skimmer O-Ring	NexION	09902123
Hyper Skimmer Screw	NexION	WE027484
Hyper Skimmer Sampler Gasket	NexION	W1040148



Part No.
N8145319



Part No.
N8145320

ConeGuard Thread Protector

When cleaning cones which have a screw thread, it is important that the thread is not contacted by any corrosive solution. If the thread gets corroded, the cone may not seal correctly or it may bond to the base and be difficult to remove.

Sampler and Skimmer Cone O-Rings



ICP-MS Model	Type	Qty.	Part No.
ELAN 9000/6x00/DRC	Sampler	5	N8120511
ELAN 9000/6x00/DRC	Skimmer	5	N8120512

ICP-MS Model	Type	Part No.
NexION	Sampler ConeGuard	N8145319
NexION	Skimmer ConeGuard	N8145320
ELAN	Skimmer ConeGuard	N8121086

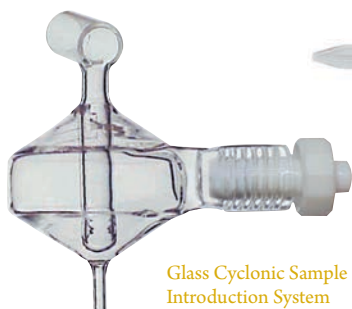

Glass Cyclonic Sample Introduction System

Glass Cyclonic Sample Introduction System for ELAN

Description	Part No.
Glass Cyclonic Sample Introduction System	N8120518
Kit includes (1 of each):	
Baffled Glass Cyclonic Spray Chamber O-Ring Free	N0775352
Cyclonic Spray Chamber Mount	WE014034
MicroMist Micro-uptake Glass Concentric Nebulizer 0.2 mL/min.	N0775342
Quartz Injector 2.0 mm i.d.	N8125029
Tygon Tubing (1 foot)	02506516
Insert	09903094
¼ in. Front Ferrule	09903456
Fitting	09903464
Tube Fitting	09903465
Red/Red Standard PVC Tubing 1.14 mm i.d. (Pkg. 12)	09908585
Green/Yellow Flared End PVC Tubing 0.44 mm i.d. (Pkg. 6)	N0773113

Quartz Cyclonic Sample Introduction System for ELAN

Description	Part No.
Quartz Cyclonic Sample Introduction System	N8120519
Kit includes (1 of each):	
Baffled Quartz Cyclonic Spray Chamber Baffled Quartz Spray Chamber (PTFE O-Ring Type) with Ball Joint.	WE025221
MicroMist Micro-uptake Glass Concentric Nebulizer Offers High Performance for Limited Sample Volumes. Fitted with an EzyFit Connector with 1.3 o.d. x 0.50 mm i.d. x 700 mm Long Sample Tubing.	N0775342
Quartz Ball Injector 2.0 mm i.d.	WE023948
Tygon Tubing (1 foot)	02506516
Insert	09903094
¼ in. Front Ferrule	09903456
Fitting	09903464
Tube Fitting	09903465
Red/Red Standard PVC Tubing 1.14 mm i.d. (Pkg. 12)	09908585
Green/Yellow Flared End PVC Tubing 0.44 mm i.d. (Pkg. 6)	N0773113
Ball Joint Cassette Torch Injector Support Adapter	W1012406
UV Safety Shield	W1020996
Connector 1A	B0199233



ELAN® DRC-e/9000 Spares Kit

Description	Qty	Part No.
ELAN® DRC-e/9000 Spares Kit		N8120610
Kit Includes:		
Demountable Quartz Torch	1	N8122006
RF Coil Assembly	1	WE021816
Alumina Injector 2.0 mm i.d.	1	N8126041
Cross-Flow II Replacement GemTips™	1	N8120515
Series II Ion Lens	1	WE018034
Nickel Sampler Cones	2	WE021140
Nickel Skimmer Cones	2	WE021137
Sampler Cone O-Rings (Pkg. 5)	1	N8120511
Skimmer Cone O-Rings (Pkg. 5)	1	N8120512



ELAN® DRC II Spares Kit

Description	Qty	Part No.
ELAN® DRC II Spares Kit		N8120611
Kit Includes:		
Demountable Quartz Torch	1	N8122006
RF Coil Assembly	1	WE021816
Quartz Ball Joint Injector 2.0 mm i.d.	1	WE023948
Series II Ion Lens	1	WE018034
Platinum Sampler Cone	1	WE027802
Platinum Skimmer Cone	1	WE027803
Sampler Cone O-Rings (Pkg. 5)	1	N8120511
Skimmer Cone O-Rings (Pkg. 5)	1	N8120512
Skimmer Cone O-Rings (Pkg. 5)	1	N8120512





NexION 300/350Q/X/D Consumables Kit

Typical one year's supply of consumables.

Description	Qty	Part No.
NexION 300/350Q/X/D Consumables Kit		N8140513
Kit Includes:		
Demountable Quartz Torch	2	N8122006
Load Coil	1	WE021816
Quartz Ball Joint Injector 2.0 mm i.d.	2	WE023948
Cassette Torch Injector Support Adapter for Ball Joint Injectors	1	W1012406
Glass Cyclonic Spray Chamber	1	N8145014
Nickel Skimmer Cone	2	W1026356
Nickel Sampler Cone	2	W1033612
Hyper Skimmer Cone	1	W1033995
Sampler Cone Gasket	3	W1040148
Hyper Skimmer O-Ring	2	09902123
Hyper Skimmer Screw	2	09919737
Santoprene® 1.30 mm Gray/Gray Pump Tubing	4	N0777444
Flared PVC 0.38 mm Green/Orange Pump Tubing	4	N0777042
Drain Tubing (feet)	6	02506495
Sample Uptake Tubing (cm)	12	WE024375
Instrument Filter (left)	2	W1036712
Instrument Filter (back right)	2	W1036713
Spray Chamber Drain Fitting	2	N8145015
Nebulizer Fitting	2	N8145016
Male Barb CTFE Fitting	2	N8145017
Female Barb CTFE Fitting	2	N8145018



NexION 300/350S Consumables Kit

Typical one year's supply of consumables.

Description	Qty	Part No.
NexION 300/350S Consumables Kit		N8140514
Kit Includes:		
Demountable Quartz Torch	2	N8122006
Load Coil	1	WE021816
Quartz Ball Joint Injector 2.0 mm i.d.	2	WE023948
Cassette Torch Injector Support Adapter for Ball Joint Injectors	1	W1012406
Quartz Cyclonic Spray Chamber	1	N8145013
Platinum Skimmer Cone	1	W1026907
Platinum Sampler Cone	1	W1033614
Hyper Skimmer Cone	1	W1033995
Sampler Cone Gasket	3	W1040148
Hyper Skimmer O-Ring	2	09902123
Hyper Skimmer Screw	2	09919737
Santoprene® 1.30 mm Gray/Gray Pump Tubing	4	N0777444
Flared PVC 0.38 mm Green/Orange Pump Tubing	4	N0777042
Drain Tubing (feet)	6	02506495
Sample Uptake Tubing (cm)	12	WE024375
Instrument Filter (left)	1	W1036712
Instrument Filter (back right)	1	W1036713
Spray Chamber Drain Fitting	2	N8145015
Nebulizer Fitting	2	N8145016
Male Barb CTFE Fitting	2	N8145017
Female Barb CTFE Fitting	2	N8145018



NexION Spares

Description	Part No.
Metal Spill Tray for vacuum pump	N8145022
UV Shield/Spray Chamber Nut	W1037267
Instrument Filter (left)	W1036712
Instrument Filter (back right)	W1036713
NexION Sample Tray	N8141206
Sample Spill Tray	W5005586

ENSURE INSTRUMENT REPRODUCIBILITY

Two-Stop Peristaltic Pump Tubing

PerkinElmer offers a wide range of high-quality peristaltic pump tubing for all of your ICP-OES and ICP-MS applications. Remember to replace your tubing frequently and always keep spares on hand.



Two-Stop Peristaltic Pump Tubing

i.d. (mm)	Stop Colors	Standard PVC (Pkg 12)	Flared PVC (Pkg 12)	Solvent Flex (Pkg 12)	Viton® (Pkg 12)	Santoprene® (Pkg 12)	Silicone (Pkg 6)
0.19	orange red	N0695476	N0773111				
0.25	orange blue	N0773117	N0773112				
0.38	orange green	N0777110	N0777042	N0777874			
0.44	green yellow		N0773113				
0.51	orange yellow		N0777476		N0777446		
0.64	orange white		N0777711				
0.76	black black	09908587	N0777043	00473550	N0773118		00473552
1.02	white white				N0777442		N0777441
1.14	red red	09908585		09923037	N0773115	N0773119	N0691595
1.30	grey grey				N0777445	N0777444	N0777443
1.42	yellow yellow	N0777521					
1.52	yellow blue	09923536					
1.65	blue blue				N0777447		
1.85	green green	N0777518				N0773116	
2.06	purple purple	N0777561					
2.79	purple white			02508080			09923448
3.18	black white	N8122012					



Internal Standard Kits

In-line Standard Additions kits, one which includes a glass mixing chamber/combiner for solutions which do not contain HF and another which includes an inert mixing chamber/combiner. Both kits are completely modular so that damaged or worn components can easily be replaced. The heart of the kit is the mixing chamber/combiner. It is designed for zero dead volume on the input ends which accommodate the sample and addition lines. The output end is designed with a small mixing chamber so that the sample and added reagent are intimately mixed prior to introduction to the nebulizer. All connections to the mixing chamber/combiner use EzyFit connectors. A sampling probe for the reagent addition bottle is included so that it remains well anchored in the bottle. Inline addition of internal standards and ionization buffers provides an efficient means of accurately and precisely dosing all of your samples without extra effort or the risk of error or contamination. Internal standardization is often used to compensate for physical and mass-space interferences in ICP spectrometry. In many cases, it also enhances short-term and long-term reproducibility.

HF-Resistant Internal Standard Kit

Description	Part No.
HF-Resistant Internal Standard Kit	N0774067
Includes:	
HF Mixing T-piece	N0777466
Internal Standard Sample Probe 0.25 mm ID	N0777465
EzyFit Sample Tube 0.5 mm ID	N0777463
EzyFit with 1/16 inch OD x 0.50 mm ID x 700 mm Long Sample Tube	N0777436
EzyFit Internal Standard Tube 0.25 mm ID	N0777464
Vitex® Gripper Paper - Qty. 6	N0777848
Orange-Blue Flared End PVC Tubing 0.25 mm ID – Qty. 12	N0773112

HF-Resistant Internal Standard Kit

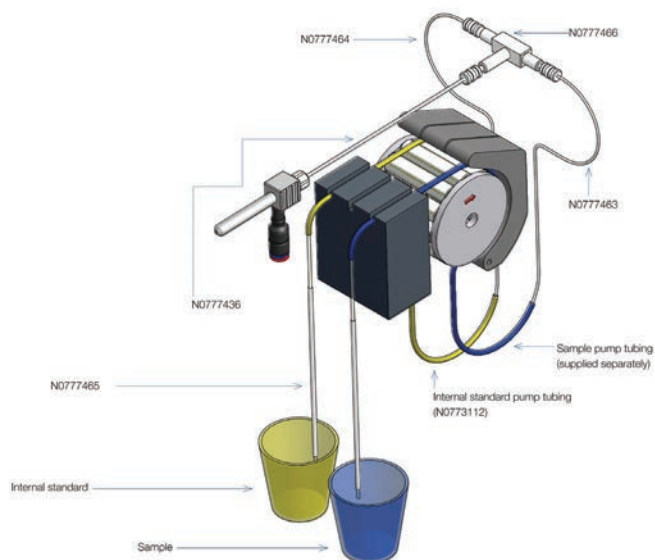

Non HF-Resistant Internal Standard Kit

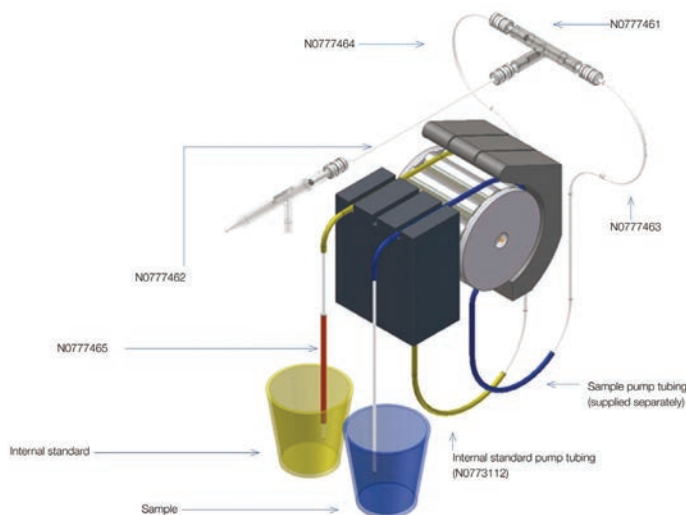

Non HF-Resistant Internal Standard Kit

Description	Part No.
Non HF-Resistant Internal Standard Kit	N0774068
Includes:	
HF Mixing T-piece	N0777466
Internal Standard Sample Probe 0.25 mm ID	N0777465
EzyFit Sample Tube 0.5 mm ID	N0777463
EzyFit with 1/16 inch OD x 0.50 mm ID x 700 mm Long Sample Tube	N0777436
EzyFit Internal Standard Tube 0.25 mm ID	N0777464
Vitex® Gripper Paper - Qty. 6	N0777848
Orange-Blue Flared End PVC Tubing 0.25 mm ID – Qty. 12	N0773112

ESI MP² Two-Stop Peristaltic Pump Tubing



i.d. (mm)	Stop Colors	Calibration Slope ($\mu\text{L}/\text{min}$ per RPM)	Non-Flared			Flared*	
			PVC 2-stop	Santoprene 2-stop	Solva 2-stop	PVC 2-stop	Solva 2-stop
0.13	orange black	0.6	N8145145			N8145194	N8145208
0.19	orange red	1.3	N8145146			N8145195	N8145209
0.27	orange blue	2.7	N8145147			N8145196	N8145210
0.38	orange green	4.7	N8145148	N8145171		N8145197	N8145211
0.44	green yellow	7.6	N8145149			N8145198	N8145212
0.51	orange yellow	9.5	N8145150			N8145199	N8145213
0.57	white yellow	11	N8145151			N8145200	N8145214
0.64	orange white	14	N8145152			N8145201	N8145215
0.76	black black	19	N8145153	N8145172	N8145176	N8145202	N8145216
0.89	orange orange	24	N8145154			N8145177	N8145217
0.95	white black	28	N8145155			N8145178	N8145218
1.02	white white	31	N8145156			N8145179	N8145219
1.09	white red	33	N8145157			N8145180	N8145220
1.14	red red	35	N8145158			N8145181	N8145207
1.22	red grey	46	N8145159			N8145182	
1.30	grey grey	47	N8145160	N8145173	N8145183		
1.42	yellow yellow	50	N8145161			N8145184	
1.52	yellow blue	51	N8145162	N8145174	N8145185		
1.65	blue blue	55	N8145163			N8145186	
1.75	blue green	58	N8145164			N8145187	
1.85	green green	61	N8145165			N8145188	
2.06	purple purple	64	N8145166			N8145189	
2.20	purple black	65	N8145167			N8145190	
2.54	purple orange	67	N8145168			N8145191	
2.79	purple white	69	N8145169			N8145192	
3.17	black white	70	N8145170	N8145175	N8145193		
Bridge Length			72 mm	72 mm	72 mm	72 mm	72 mm

* For easy insertion of PFA capillaries

i.d. = internal diameter

Non-Flared



PVC

Santoprene

SOLVA

Three-Stop Peristaltic Pump Tubing

i.d. (mm)	Stop Colors	Standard PVC Clear (Pkg 12)	Pharmed Tan (Pkg 12)	Solvent Resistant Yellow (Pkg 12)
1.65	black black black	B0506058		
1.75	white white white			B0507692
1.85	red red red	B0193160	*B3140730	
2.06	yellow blue yellow	B0193161		
2.20	purple purple purple	B0199034		
2.54	purple white purple		*B3140721	
2.79	black white black	B0508310		
0.51	orange yellow orange	B0506737		

* Used for S10 and AS9X autosamplers

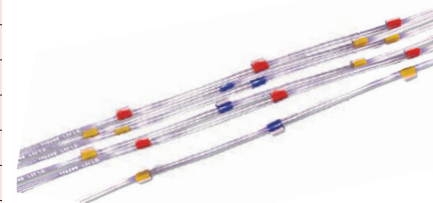

AUTOSAMPLER PROBES AND COMPONENTS

PerkinElmer AS-90/90A/90plus/ 91/93plus/S10 Sampling Probe Assemblies Stainless Steel



Description	Part No.
Flame Sampling Probe Assembly, 0.6 mm i.d. Includes Stainless Steel Sampling Probe and Screw Fitting (B3000152) and Flame Capillary (B3000157 – replaces B0196963) Tubing Assembly.	B3000159
FIAS™ Sampling Probe Assembly, 0.6 mm i.d. Includes Stainless Steel Sampling Probe and Screw Fitting (B3000152) and FIAS Capillary Tubing Assembly (B3000158 – replaces B0196966).	B3000160
FIAS Standard Sampling Probe Assembly, 1.0 mm i.d. Includes Stainless Steel Sampling Probe and Screw Fitting (B3000152) and FIAS Capillary Tubing Assembly (B0191060 – replaces B0501044).	B3000161

Corrosion-Resistant

Corrosion-resistant probes are suitable for inorganic acids and most organic solvents, except NMP.

Description	Part No.
Flame Sampling Probe Assembly, 0.6 mm i.d.* Includes Sampling Probe with FEP Tube and Screw Fitting (B3000055) and Capillary Tubing Assembly (B3000157). Standard with AS93plus/S10.	B3001770
FIAS Sampling Probe Assembly, 0.6 mm i.d.* Includes Sampling Probe with FEP Tube and Screw Fitting (B3000055) and FIAS Capillary Tubing Assembly (B3000158).	B3001771
FIAS Standard Sampling Probe Assembly, 1.0 mm i.d.* Includes Sampling Probe with FEP Tube and Screw Fitting (B3001769) and Capillary Tubing Assembly (B0191060).	B3001772

*This probe cannot be used with AS-90s, with the older sampling probe holder.

Sampling Probe Assembly Components

Description	Part No.
Stainless Steel Sampling Probe with Screw Fitting Requires, but does not include, one of the capillary tubing assemblies described below.	B3000152
Flame Capillary Tubing Assembly 1 m length, 0.6 mm i.d., one fitting (red)	B3000157
FIAS Capillary Tubing Assembly 1 m length, 0.6 mm i.d., two fittings (red)	B3000158
FIAS Capillary Tubing Assembly 1 m length, 1.0 mm i.d., two fittings (blue)	B0191060

Description	Part No.
Corrosion-Resistant Probe only 0.6 mm	B3000055
Corrosion-Resistant Probe only 0.1.0 mm	B3001769
O-Ring to hold Probe	B0172053
Probe Holder (white plastic)	B3000151

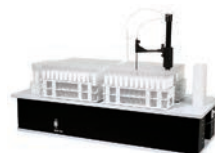

ESI Autosampler Probes

Description	Part No.
Autosampler Probes	
Autosampler Probe, 0.15 mm	N0777221
Autosampler Probe, 0.20 mm	N0777222
Autosampler Probe, 0.25 mm	N0777223
Autosampler Probe, 0.30 mm	N0777224
Autosampler Probe, 0.50 mm	N0777225
Autosampler Probe, 0.80 mm	N0777226
Sample Probes	
High Flow, Carbon Fiber Support, 0.8 mm i.d. (blue)	N0777285
Low Flow, Carbon Fiber Support, 0.8 mm i.d. (blue)	N0777266
Sample Probe Line Holder	N0777227
Carrier Probes	
High Flow, Carbon Fiber Support, 0.5 mm i.d. (orange)	N0777286
Low Flow, Carbon Fiber Support, 0.5 mm i.d. (orange)	N0777267



Cetac Carbon Fiber Autosampler Probes

Probes reinforced with rigid carbon fiber to ensure probe accuracy without the use of a guide plate when mounted to a Z-drive with double probe clamps.

Description	Part No.
0.5 Blue 0.5 mm ID x 108 in - Teflon	N0777547
1.0 2 Blue 1.0 mm ID x 75 in - Teflon	N0777568

Cetac Ultem Autosampler Probes

Probes made with Ultem brand polyetherimide resin are more flexible than the carbon fiber reinforced probes. Use of a Z-drive-mounted guide plate is required.

Description	Part No.
0.5 mm Blue 0.5 mm ID x 108 in - Teflon	N0774088
1.0 mm 2 Blue 1.0 mm ID x 75 in - Teflon	N0777565

Cetac Stainless Steel Autosampler Probe

Description	Part No.
Steel probe with screen tip (100 mesh) designed for oil analysis.	N0771529

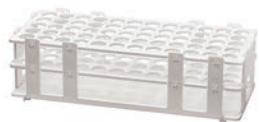

PerkinElmer Sample Trays

AS-93plus/S10 Sample Trays

Description/Capacity	Sample Vessel Size	Part No.
Tray F – 9/29* ¹	50 mL/15 mL	B3001647
Tray E – 90 ²	4.5 mL, 6 mL, 8 mL	B3140617
Tray H & Tray F – 60 ³	15 mL, 16 mL	B3140618
Tray E, H & Tray G – 21 ⁴	50 mL	B3140621

* AS-93plus/S10 sample trays are polypropylene.

¹ Rack B3001647 (rinsing-port rack) with rinsing port location (location 0), 8 locations for 50 mL solution containers (calibration and/or test sample solutions), and 29 locations for 15 mL solution containers (test sample solutions).

² Rack B3140617 each with 90 locations for 6 mL and 8 mL solution containers (test sample solutions).

³ Rack B3140618 with 60 locations for 15 mL solution containers (test sample solutions).

⁴ Rack B3140621 with 21 locations each for 50 mL solution containers (calibration and/or test sample solutions). Location 0 in the first rack is for the rinsing port.

AS-90/90A/90plus Sample Trays

Description/Capacity	Sample Vessel Size	Part No.
Tray A – 144	4.5 mL, 6 mL, 8 mL	B3000133
Tray B – 98*	15 mL, 16 mL	B3000132
Tray C – 36	50 mL	B3000135
Blank Tray		B0501056

*Polypropylene sample tray.

AS-91 Sample Trays

Description/Capacity	Sample Vessel Size	Part No.
Tray E – 218	4.5 mL, 6 mL, 8 mL	B0509554
8 - 50 mL spots & Tray F – 152 / 8 (160)	15 mL, 16 mL	B0509555
Tray G – 55	50 mL	B0508520

Trays A, C, E, F and G are powder-coated, corrosion-resistant aluminum.

AS-93plus/S10 Rinsing Kit

Description/Capacity	Part No.
AS-93plus/S10 Rinsing Kit	B3140236

Spare Parts

Rinsing Port	B3140622
Adapter M	B0507919
Pump Tube – 2.79 mm i.d. (pkg. 6) purple-white	B3140721
Pump Tube – 1.14 mm i.d. (pkg. 6)	B3140730
Tygon® Drain Tube – 2 m red-red-red	B0018283
PVC Rinse Liquid Feed Tube – 1 m	B0048139
Connector	B3140715



Cetac Autosampler Racks

Racks

Rack	Vial Size	Part No.
21-Position, 30.5 mm square opening	50 mL	N0777152
24-Position, 25.2 mm square opening	30 mL	N0777151
40-Position, 20.6 mm square opening	20 mL	N0777150
30-Position Tall Rack, square opening	14 mL	N0777062
40-Position	20 mL	N0777169
40-Position/Gilson 29	20 mL	N0777155
45-Position/120 cc Sample Rack (oils)		N0777298
60-Position, 17.0 mm square opening	14 mL or 15mL	N0777149
80-Position Collection Metal for Oil	15mL	N0774085
90-Position, 13.5 mm square opening	7 mL or 8 mL	N0777148
90-Position, 13.3 mm round opening	7 mL or 8 mL	N0777153
90-Position Collection Metal for Oil	8 mL	N0777154



ESI Autosampler Racks

Racks and Rack Covers

Description	Size	Diameter	Part No.
Standard Racks			
10-Position		28 mm	N0777228
24-Position	4 x 6	14 mm	N0777234
Adapter Plate**			N0777235

**For Gemetec/Cetac ASX-100's racks

Micro Racks

21-Position	3 x 7	14 mm	N0777229
40-Position	4 x 10	14 mm	N0777230
60-Position	5 x 12	8 mm	N0777231
90-Position	5 x 12		N0777232
Cover for Micro Racks			N0777233

Large Racks

21-Position	3 x 7	30 mm	N0777242
40-Position	4 x 10	20 mm	N0777243
60-Position	5 x 12	16 mm	N0777244
90-Position	6 x 15	13 mm	N0777245

Super Racks

10-Position***	2 x 5	61 mm	N0777253
12-Position	2 x 6	50 mm	N0777252
21-Position	3 x 7	22 mm	N0777251
21-Position	3 x 7	28 mm	N0777250
21-Position	3 x 7	30 mm	N0777249
27-Position	3 x 9	28 mm	N0777248
80-Position	5 x 16	16 mm	N0777247
120-Position	6 x 20	13 mm	N0777246

***Holds 205 mL bottles.

Polypropylene Autosampler Tubes

PerkinElmer translucent polypropylene tubes are designed to provide excellent chemical resistance. PerformR™ 15 mL and 50 mL conical tubes are designed for your routine everyday applications and storage needs. SuperClear™ tubes are made from a unique medical grade resin. PerformR and SuperClear tubes are available with either a flat cap with a two stage seal, or a plug style cap that includes a very deep sealing area.



Round Bottom Tubes



Description	Type	Size	Pack	Qty	Part No.
5 mL without caps	Standard	12 mm x 75 mm	Bulk	500	B0193235
8 mL without caps	Standard	13 mm x 100 mm	Bulk	1200	N0777156
8 mL without caps	Standard	13 mm x 100 mm	250/bag	1000	N0777159
8 mL without caps	Standard	13 mm x 100 mm	Bulk	1000	B0508901
14 mL without caps	Standard	17 mm x 100 mm	Bulk	1000	N0777940
14 mL with Dual Position, Polyethylene Caps included	Standard	17 mm x 100 mm	Bulk	1000	N0777941
Dual Position Caps for 14 mL, N0777940 Tubes (clear) Caps Only	Standard		Bulk	1000	N0777942
14 mL without caps	Standard	17 mm x 100 mm	250/bag	1000	N0777168
15 mL without plugs	Standard	17 mm x 100 mm	Bulk	1200	N0777167
Plugs for 15 mL N0777167 Tubes, (blue) Plugs Only	Standard		Bulk	1200	N0777599
15 mL Graduated without plugs	Standard	17 mm x 100 mm	Bulk	2000	N0777071
Plugs for 15 mL N0777071 Tubes, (white) Plugs Only	Standard		Bulk	1000	N0777072
16 mL without caps	Standard	17 mm x 100 mm	250/bag	1000	N9301205

Conical Bottom Tubes with Graduation



Description	Type	Size	Pack	Qty	Part No.
15 mL with Red Flat Caps attached, (Standard PerkinElmer S10 Tubes)	Standard	17 mm x 120 mm	50/bag	500	B0193233
15 mL Sterile Tubes, with Teal Flat Caps attached	Sterile	17 mm x 118 mm	50/bag	500	N0774095
15 mL Metal Free Sterile Tubes Racked with White Flat Caps	Sterile	17 mm x 118 mm	25/Rack	500	N0776118
15 mL with Teal Flat Caps attached	SuperClear	17 mm x 118 mm	50/bag	500	N0777701
15 mL with Teal Flat Caps attached	SuperClear	17 mm x 118 mm	Racked 50/bag	500	N0777702
15 mL with Teal Flat Caps attached	SuperClear	17 mm x 118 mm	Bulk	500	N0777703
15 mL with Teal Flat Caps attached	SuperClear	17 mm x 118 mm	50/bag	500	N0777704
15 mL with Teal Flat Caps attached	SuperClear		Racked 50/bag	500	N0777705
15 mL with Teal Plug Caps	SuperClear	17 mm x 118 mm	Bulk	500	N0777706
50 mL with Red Flat Caps attached, (Standard PerkinElmer S10 Tubes), Freestanding	Standard	28 mm x 115 mm	25/bag	500	B0193234
50 mL with Red Flat Caps attached	Standard	28 mm x 114 mm	25/bag	300	N0777901
50 mL with Teal Flat Caps attached, Freestanding	PerformR	30 mm x 116 mm	50/bag	500	N0777697
50 mL with Teal Flat Caps attached, Freestanding	PerformR	30 mm x 116 mm	Bulk	500	N0777698
50 mL with Teal Plug Caps attached, Freestanding	PerformR	30 mm x 116 mm	50/bag	500	N0777699
50 mL with Teal Plug Caps included, Freestanding	PerformR	30 mm x 116 mm	Bulk	500	N0777700
50 mL Sterile Tubes with Teal Flat Caps attached	Sterile	29 mm x 115 mm	50/bag	500	N0774096
50 mL Metal Free Sterile Tubes Racked with White Flat Caps	Sterile	30 mm x 116 mm	25/Rack	500	N0776116
50 mL with Teal Flat Caps attached	SuperClear	29 mm x 115 mm	50/bag	500	N0777691
50 mL with Teal Flat Caps attached	SuperClear	29 mm x 115 mm	Racked 50/bag	500	N0777692
50 mL with Teal Flat Caps included	SuperClear	29 mm x 115 mm	Bulk	500	N0777693
50 mL with Teal Plug Caps attached	SuperClear	29 mm x 115 mm	50/bag	500	N0777694
50 mL with Teal Plug Caps attached	SuperClear	29 mm x 115 mm	Racked 50/bag	500	N0777695
50 mL with Teal Plug Caps included	SuperClear	29 mm x 115 mm	Bulk	500	N0777696

PIONEERED THE USE OF FLOW INJECTION TECHNIQUES



FIMS



FIAS

The use of flow injection saves time, money and manpower — while at the same time, extending your analytical flexibility and capabilities.

PerkinElmer carries a wide selection of genuine supplies and accessories for your FIMS-100, FIMS-400, FIAS-100 or FIAS-400. Keeping your system in good working order by using only the best replacement parts is the first step in assuring quality analytical performance. Regular maintenance and/or replacement of consumables such as tubing, connectors and adapters will maximize the lifetime and productivity of your PerkinElmer flow injection system.

Adapters with Internal Thread

¼ in (6.4 mm) Internal Screw Thread

Type*	Description	Part No.
A B	A 1.8 mm o.d. nipple B 3.3 mm o.d. nipple	B0193342 B0506716
C	4 mm o.d. nipple	B0196850
E	For the quartz cell	B0196857
F	0.7 mm o.d. Pt/Ir capillary nipple	B0193873
G	Two nipples to connect tubes to the pre-concentration accessory	B0501580

Connectors

Type*	Description	Part No.
IA	Connector with nipples for 1.7 to 3.2 mm i.d. tubes	B0199233
IB	Connector with nipples for 2.4 to 3.2 mm i.d. tubes	B0196882
II	Connector with ¼ in (6.4 mm) internal screw thread	B0196704
IIIA	T-piece with nipples for 1.5 to 2.5 mm i.d. tubes	B0199035
IIIB	T-piece with nipples for 3.5 to 4.5 mm i.d. tubes	B0198201

Adapters with External Thread

¼ in (6.4 mm) External Screw Thread

Type*	Description	Part No.
K L	K 1.8 mm o.d. nipple L 2.8 mm o.d. nipple	B0507918 B0507920
M	4 mm o.d. nipple	B0507919
N	0.7 mm o.d. Pt/Ir capillary nipple	B0507949
	Screw Plug	B0507921

*Type designation refers to diagrams in instrument manuals.

FIAS/FIMS Cell Replacement Parts

Description	Part No.
Complete FIAS Cell and Windows	B0507486
FIAS Cell only (no windows)	B0507487
Quartz Windows for FIAS or FIMS	B0066549
FIMS Complete Cell and Windows	B0510334
FIMS Cell Only (no windows)	B0510370
FIMS Hg Lamp	B3000243
FIMS Hg Filter Replacement for Hg Scrubber	B3000274

Mixing/Separation Assembly

Complete modular unit, consisting of two mixing manifolds with tubing adapters, a gas liquid separator with a PTFE membrane, five spare PTFE membranes, one PTFE tube (110 mm long) and one PTFE tube (300 mm long).

Description	Part No.
Mixing/Separation Assembly	B0507957

Mixing Block

Modular “building block” type mixing manifold with one mixing channel and three connections, two inlet and one outlet. Made from chemically-resistant plastic. Several of these blocks can be “plugged” together easily to create a single unit with enhanced mixing capabilities.



Description	Part No.
Mixing Block	B0507962

Gas/Liquid Separator

Modular “building block” type gas-liquid separator made from chemically-resistant plastic. An exchangeable PTFE membrane in the screw cap of the separator prevents liquid from being carried into the quartz cell when working with strong foaming samples.



Description	Part No.
Gas/Liquid Separator	B0507959
Glass Gas/Liquid Separator	B0193772
Gas/Liquid Separator Holder for Glass Separator	B0509479
PTFE Membrane (pkg. 50)	B0508306
Mixing Manifold for Glass Gas/Liquid Separator	B0187258

Tool, Screw Connectors

Description	Part No.
Tool, Screw Connectors	B0501315

Flow Injection Furnace Supplies

Description	Part No.
FIAS-Furnace Sample Transfer Tube	B0509612
Quartz Pipette Tip/20 mm (pkg. 1)	B0510032
Silicone Tube	B0029796

Sample Loops

Description	Part No.
200 µL	B0194048
500 µL	B0194049
1,000 µL	B0501000

Tubing

Standard PVC clear peristaltic pump tubing has a wall thickness of 0.84 mm.

Three-Stop Peristaltic Pump Tubing, Pkg. 12

Tubing i.d.	Color Code	Part No.
0.76 mm	Black/black	B0506058
1.14 mm	Red/red	B0193160
1.52 mm	Yellow/blue	B0193161
2.06 mm	Violet/violet	B0199034
3.18 mm	Black/white	B0508310

Solvent Resistant Yellow Peristaltic Pump Tubing, Pkg. 12

Tubing i.d.	Color Code	Part No.
1.02mm	White/white	B0507692

PTFE Tubing

Tubing i.d.	Length	Part No.
0.35 mm	1 m	B0506060
0.5 mm	1 m	B0507020
0.7 mm	1 m	B0507021
1.0 mm	1 m	B0029792
1.75 mm	1 m	B0017998

PTFE Tubing Assemblies

Tubing i.d.	Screw Fittings Color	Length	Part No.
0.35 mm	White	60 mm	B0501594
1.0 mm	Blue	110 mm	B0191058
1.0 mm	Blue	300 mm	B0198097
1.0 mm	Blue	700 mm	B0191059
1.0 mm	Blue	1,000 mm	B0191060
1.75 mm	Black	250 mm	B0198099
1.75 mm	Black	450 mm	B0198100
3-dimensional reactor 0.35 mm (two flanged ends)			B0501595

PVC Tubing

Description	Part No.
3 mm i.d. with 1 mm wall thickness, no fittings	B0048139

Price per meter.

Silicone Tubing

Description	Part No.
1 m x 5 mm i.d., no fittings	B0018283
1 m x 3 mm i.d.	B0070126
For FIMS Cell Exhaust Outlet, 3 m	B0046948

EXPERIENCE RELIABLE, ACCURATE RESULTS



Inorganic Aqueous Standards

PerkinElmer offers a complete selection of atomic spectroscopy aqueous standards. Each solution is supplied with a comprehensive Certificate of Analysis that documents the quality and reliability.

Single-Element Standards – 1,000 µg/mL

Element	Symbol	Matrix	Pure Grade 125 mL Part No.	Pure Grade 500 mL Part No.	Pure Plus Grade 125 mL Part No.
Aluminum	Al	2% HNO ₃	N9300184	N9300100	N9303726
Antimony	Sb	2% HNO ₃	N9300207	N9300101	N9303750
Arsenic	As	2% HNO ₃	N9300180	N9300102	N9303727
Barium	Ba	2% HNO ₃	N9300181	N9300103	N9303729
Beryllium	Be	2% HNO ₃	N9300172	N9300104	N9303730
Bismuth	Bi	10% HNO ₃	N9303761	N9300105	N9303731
Boron	B	H ₂ O		N9303760	N9300106
Cadmium	Cd	2% HNO ₃	N9300176	N9300107	N9303734
Calcium	Ca	2% HNO ₃	N9303763	N9300108	N9303733
Carbon	C	H ₂ O		N9303762	N9300109
Cerium	Ce	2% HNO ₃	N9303765	N9300110	
Cesium	Cs	2% HNO ₃	N9303767	N9300111	
Chromium	Cr	2% HNO ₃	N9300173	N9300112	N9303736
Cobalt	Co	2% HNO ₃	N9303766	N9300113	N9303735
Copper	Cu	2% HNO ₃	N9300183	N9300114	N9303737
Dysprosium	Dy	2% HNO ₃	N9303768	N9300115	
Erbium	Er	2% HNO ₃	N9303769	N9300116	
Europium	Eu	2% HNO ₃	N9303770	N9300117	
Gadolinium	Gd	2% HNO ₃	N9303773	N9300118	
Gallium	Ga	2% HNO ₃	N9303772	N9300119	
Germanium	Ge	H ₂ O/0.16% F-	N9303774	N9300120	N9303739
Gold	Au	10% HCl	N9303759	N9300121	N9303728
Hafnium	Hf	2% HCl		N9303775	N9300122
Holmium	Ho	2% HNO ₃	N9303776	N9300123	
Indium	In	2% HNO ₃	N9303777	N9300124	N9303741

Pure Grade Standards for AA and ICP-OES

- Analyzed by ICP-OES
- Analyzed by Classical Wet Assay
- 32 trace impurities analyzed by ICP-MS of the final solution and reported on the certificate
- Impurities reported at ppm level
- All Standards are prepared and certified under ISO Guide 34 and ISO 17025



Pure Plus Grade Standards for ICP-MS

- Analyzed by ICP-OES
- Analyzed by Classical Wet Assay
- 67 trace impurities analyzed by ICP-MS of the final solution and reported on the certificate
- Impurities reported at ppb level
- All Standards are prepared and certified under ISO Guide 34 and ISO 17025

Single-Element Standards – 1,000 µg/mL (con't)

Element	Symbol	Matrix	Pure Grade 125 mL Part No.	Pure Grade 500 mL Part No.	Pure Plus Grade 125 mL Part No.
Iridium	Ir	10% HCl	N9303778	N9300125	
Iron	Fe	2% HNO ₃	N9303771	N9300126	N9303738
Lanthanum	La	2% HNO ₃	N9303780	N9300127	
Lead	Pb	2% HNO ₃	N9300175	N9300128	N9303748
Lithium	Li	2% HNO ₃	N9303781	N9300129	
Lutetium	Lu	2% HNO ₃	N9303782	N9300130	
Magnesium	Mg	2% HNO ₃	N9300179	N9300131	N9303743
Manganese	Mn	2% HNO ₃	N9303783	N9300132	N9303744
Mercury	Hg	10% HNO ₃	N9300174	N9300133	N9303740
Molybdenum	Mo	H ₂ O	N9303784	N9300134	N9303745
Neodymium	Nd	2% HNO ₃	N9303787	N9300135	
Nickel	Ni	2% HNO ₃	N9300177	N9300136	N9303747
Niobium	Nb	H ₂ O/0.4% HF	N9303786	N9300137	
Palladium	Pd	10% HCl	N9303789	N9300138	
Phosphorus	P	H ₂ O	N9303788	N9300139	
Platinum	Pt	10% HCl	N9303791	N9300140	
Potassium	K	2% HNO ₃	N9303779	N9300141	N9303742
Praseodymium	Pr	2% HNO ₃	N9303790	N9300142	
Rhenium	Re	H ₂ O	N9303793	N9300143	
Rhodium	Rh	10% HCl	N9303794	N9300144	N9303749
Rubidium	Rb	2% HNO ₃	N9303792	N9300145	
Ruthenium	Ru	10% HCl	N9303795	N9300146	
Samarium	Sm	2% HNO ₃	N9303800	N9300147	
Scandium	Sc	2% HNO ₃	N9303798	N9300148	N9303751
Selenium	Se	2% HNO ₃	N9300182	N9300149	N9303752

Single-Element Standards – 1,000 µg/mL (con't)

Element	Symbol	Matrix	Pure Grade 125 mL Part No.	Pure Grade 500 mL Part No.	Pure Plus Grade 125 mL Part No.
Silicon	Si	H ₂ O	N9303799	N9300150	
Silver	Ag	2% HNO ₃	N9300171	N9300151	N9303725
Sodium	Na	2% HNO ₃	N9303785	N9300152	N9303746
Strontium	Sr	2% HNO ₃	N9303802	N9300153	
Sulfur	S	H ₂ O	N9303796	N9300154	
Tantalum	Ta	H ₂ O/0.8% HF	N9303803	N9300155	
Tellurium	Te	5% HNO ₃	N9303805	N9300156	
Terbium	Tb	2% HNO ₃	N9303804	N9300157	N9303753
Tin	Sn	20% HCl	N9303801	N9300161	N9303838
Thallium	Tl	2% HNO ₃	N9300170	N9300158	N9303755
Thorium	Th	2% HNO ₃	N9303842		
Thulium	Tm	2% HNO ₃	N9303807	N9300160	
Titanium	Ti	H ₂ O/0.24% F-	N9303806	N9300162	N9303754
Tungsten	W	H ₂ O	N9303809	N9300163	
Uranium	U	2% HNO ₃	N9303844		
Vanadium	V	2% HNO ₃	N9303808	N9300165	N9303756
Ytterbium	Yb	2% HNO ₃	N9303811	N9300166	
Yttrium	Y	2% HNO ₃	N9303810	N9300167	N9303757
Zinc	Zn	2% HNO ₃	N9300178	N9300168	N9303758
Zirconium	Zr	2% HNO ₃	N9303812	N9300169	

Single-Element Standards – 1 µg/mL

Element	Symbol	Matrix	Pure Grade 125 mL Part No.
Aluminum	Al	2% HCl	N9304200
Aluminum	Al	2% HNO ₃	N9304201
Antimony	Sb	2% HCl	N9304202
Antimony	Sb	H ₂ O/Tr.HNO ₃ /Tr.Tart	N9304203
Arsenic	As	2% HCl	N9304204
Arsenic	As	2% HNO ₃	N9304205
Barium	Ba	2% HCl	N9304206
Barium	Ba	2% HNO ₃	N9304207
Beryllium	Be	2% HNO ₃	N9304208
Bismuth	Bi	2% HNO ₃	N9304209
Boron	B	H ₂ O	N9304210
Cadmium	Cd	2% HCl	N9304211
Cadmium	Cd	2% HNO ₃	N9304212
Calcium	Ca	2% HCl	N9304213
Calcium	Ca	2% HNO ₃	N9304214
Carbon	C	H ₂ O	N9304215
Cerium	Ce	2% HNO ₃	N9304216
Cesium	Cs	2% HNO ₃	N9304217
Chromium	Cr	2% HCl	N9304218
Chromium	Cr	2% HNO ₃	N9304219
Chromium	Cr	H ₂ O	N9304220

Single-Element Standards – 1 µg/mL (con't)

Element	Symbol	Matrix	Pure Grade 125 mL Part No.
Cobalt	Co	2% HCl	N9304221
Cobalt	Co	2% HNO ₃	N9304222
Copper	Cu	2% HCl	N9304223
Copper	Cu	2% HNO ₃	N9304224
Dysprosium	Dy	2% HNO ₃	N9304225
Erbium	Er	2% HNO ₃	N9304226
Europium	Eu	2% HNO ₃	N9304227
Gadolinium	Gd	2% HNO ₃	N9304228
Gallium	Ga	2% HNO ₃	N9304229
Germanium	Ge	H ₂ O	N9304230
Gold	Au	2% HCl	N9304231
Hafnium	Hf	2% HCl	N9304232
Holmium	Ho	2% HNO ₃	N9304233
Indium	In	2% HNO ₃	N9304234
Iridium	Ir	2% HCl	N9304235
Iron	Fe	2% HCl	N9304236
Iron	Fe	2% HNO ₃	N9304237
Lanthanum	La	2% HNO ₃	N9304238
Lead	Pb	2% HNO ₃	N9304239
Lithium	Li	2% HCl	N9304240
Lithium	Li	2% HNO ₃	N9304241
Lutetium	Lu	2% HNO ₃	N9304242
Magnesium	Mg	2% HCl	N9304243
Magnesium	Mg	2% HNO ₃	N9304244
Manganese	Mn	2% HNO ₃	N9304245
Potassium	K	2% HCl	N9304247
Potassium	K	2% HNO ₃	N9304248
Molybdenum	Mo	H ₂ O	N9304249
Niobium	Nb	H ₂ O/tr HF	N9304250
Neodymium	Nd	2% HNO ₃	N9304251
Nickel	Ni	2% HNO ₃	N9304252
Palladium	Pd	2% HCl	N9304253
Phosphorus	P	H ₂ O	N9304254
Platinum	Pt	2% HCl	N9304255
Praseodymium	Pr	2% HNO ₃	N9304256
Rubidium	Rb	2% HNO ₃	N9304257
Rhenium	Re	H ₂ O	N9304258
Rhodium	Rh	2% HCl	N9304259
Ruthenium	Ru	2% HCl	N9304260
Samarium	Sm	2% HNO ₃	N9304261
Scandium	Sc	2% HNO ₃	N9304262
Selenium	Se	2% HNO ₃	N9304263
Silicon	Si	H ₂ O/tr HF	N9304264
Silver	Ag	2% HNO ₃	N9304265
Sodium	Na	2% HCl	N9304266

Single-Element Standards – 1 µg/mL (con't)

Element	Symbol	Matrix	Pure Grade 125 mL Part No.
Sodium	Na	2% HNO ₃	N9304267
Strontium	Sr	2% HCl	N9304268
Strontium	Sr	2% HNO ₃	N9304269
Sulfur	S	H ₂ O	N9304270
Tantalum	Ta	H ₂ O/tr HF	N9304271
Tellurium	Te	5% HCl	N9304272
Tellurium	Te	2% HNO ₃	N9304273
Terbium	Tb	2% HNO ₃	N9304274
Thallium	Tl	2% HNO ₃	N9304275
Thorium	Th	2% HNO ₃	N9304276
Thulium	Tm	2% HNO ₃	N9304277
Tin	Sn	5% HCl	N9304278
Tin	Sn	2% HNO ₃ /tr HF	N9304279
Titanium	Ti	H ₂ O/tr HF	N9304280
Tungsten	W	2% HNO ₃ /tr HF	N9304281
Tungsten	W	H ₂ O	N9304282
Uranium	U	2% HNO ₃	N9304283
Vanadium	V	2% HCl	N9304284
Vanadium	V	2% HNO ₃	N9304285
Ytterbium	Yb	2% HNO ₃	N9304286
Yttrium	Y	2% HNO ₃	N9304287
Zinc	Zn	2% HCl	N9304288
Zinc	Zn	2% HNO ₃	N9304289
Zirconium	Zr	2% HCl	N9304290
Zirconium	Zr	2% HNO ₃	N9304291

Single-Element Pure Plus Standards - 10 µg/mL

Element	Symbol	Matrix	Pure Plus Grade 125 mL Part No.
Bismuth	Bi	2% HNO ₃	N9303731
Germanium	Ge	H ₂ O tr HF	N9303739
Indium	In	2% HNO ₃	N9303741
Rhodium	Rh	2% HCl	N9303749
Scandium	Sc	2% HNO ₃	N9303751
Terbium	Tb	2% HNO ₃	N9303753
Yttrium	Y	2% HNO ₃	N9303757

Single-Element Pure Standards - 10,000 µg/mL

Element	Symbol	Matrix	Pure Grade 125 mL Part No.	Pure Grade 500 mL Part No.
Aluminum	Al	5% HNO ₃	N9304111	N9304110
Antimony	Sb	20% HCl		N9304292
Antimony	Sb	H ₂ O/Tartaric Acid/Tr HNO ₃	N9304294	
Arsenic	As	5% HNO ₃	N9304295	N9304296

Single-Element Pure Standards - 10,000 µg/mL (con't)

Element	Symbol	Matrix	Pure Grade 125 mL Part No.	Pure Grade 500 mL Part No.
Barium	Ba	5% HNO ₃	N9304297	N9304298
Beryllium	Be	5% HNO ₃	N9304299	N9304300
Boron	B	H ₂ O	N9304301	N9304302
Cadmium	Cd	5% HNO ₃	N9304303	N9304304
Calcium	Ca	5% HNO ₃	N0691581	N9303764
Cerium	Ce	5% HNO ₃	N9304305	N9304306
Cesium	Cs	5% HNO ₃	N9304307	N9304308
Chromium	Cr	2% HNO ₃	N9304309	N9304311
Chromium	Cr	5% HCl		N9304310
Chromium	Cr	H ₂ O		N9304312
Cobalt	Co	5% HNO ₃	N9304313	N9304314
Copper	Cu	5% HNO ₃	N9304112	N9300283
Erbium	Er	5% HNO ₃		N9304315
Gadolinium	Gd	5% HNO ₃	N9304316	N9304317
Iron	Fe	5% HNO ₃	N9304113	N9307117
Lanthanum	La	5% HNO ₃	N9304318	N9304319
Lead	Pb	5% HNO ₃	N9304321	N9304320
Lithium	Li	5% HCl		N9304322
Lithium	Li	5% HNO ₃	N9304323	N9304324
Magnesium	Mg	5% HNO ₃	N0691745	N9304114
Manganese	Mn	5% HNO ₃	N9304115	
Mercury	Hg	10% HNO ₃	N9304325	N9304326
Molybdenum	Mo	H ₂ O	N9304327	N9304328
Nickel	Ni	5% HNO ₃	N9304117	N9304116
Niobium	Nb	H ₂ O		N9304329
Niobium	Nb	H ₂ O/tr HF	N9304330	
Phosphorus	P	H ₂ O	N9304119	N9304118
Potassium	K	5% HNO ₃	N9304121	N9304120
Rubidium	Rb	2% HNO ₃	N9304331	N9304332
Scandium	Sc	2% HNO ₃	N9304333	
Scandium	Sc	5% HNO ₃	N9304334	
Selenium	Se	5% HNO ₃	N9304335	N9304336
Silicon	Si	H ₂ O/4% F-	N9304122	
Silver	Ag	5% HNO ₃	N9304337	N9304338
Sodium	Na	5% HNO ₃	N9304124	N9304123
Strontium	Sr	5% HCl	N9304339	
Strontium	Sr	5% HNO ₃	N9304340	N9304341
Sulfur	S	H ₂ O	N9304126	N9304125
Tantalum	Ta	H ₂ O		N9304342
Tantalum	Ta	H ₂ O/tr HF	N9304343	
Tin	Sn	HNO ₃ /2% HF		N9304344
Tin	Sn	20% HCl	N9304345	N9304346
Titanium	Ti	40% HCl		N9304347
Titanium	Ti	H ₂ O	N9304348	N9304349
Tungsten	W	2% HNO ₃ /5% HF		N9304350

Single-Element Pure Standards - 10,000 µg/mL (con't)

Element	Symbol	Matrix	Pure Grade 125 mL Part No.	Pure Grade 500 mL Part No.
Tungsten	W	H ₂ O	N9304351	N9304352
Uranium	U	5% HNO ₃	N9304353	N9304354
Vanadium	V	15% HCl		N9304355
Vanadium	V	15% HNO ₃	N9304356	N9304357
Yttrium	Y	5% HNO ₃	N9304128	N9304127
Zinc	Zn	5% HNO ₃	N9304129	
Zirconium	Zr	10% HCl		N9304358
Zirconium	Zr	5% HNO ₃	N9304359	N9304360

STANDARDS FOR ALL YOUR LABORATORY NEEDS

Our go-to multi-element standards are suitable for your daily laboratory needs. Spanning across a wide range of applications and methods, you'll find the right solution to help you achieve laboratory success.

Multi-Element Standards

Matrix	Contents	Vol.	Part No.
Multi-Element Solution			
5% HNO ₃	1,000 µg/mL: Al, Ca, Fe, Mg	500 mL	N9307113
Multi-Element Solution			
5% HNO ₃	1,000 µg/mL: K, Na, P	500 mL	N9307114
Multi-Element Solution			
5% HNO ₃	1,000 µg/mL: Mo, Sb, Sn, W, Zr	500 mL	N9307115
Multi-Element Solution			
5% HNO ₃	1,000 µg/mL: As, Ba, Be, Cd, Cr, Co, Cu, La, Pb, Li, Mn, Ni, Sc, Sr, V, Y, Zn	500 mL	N9307116
5% HNO ₃ / trace HF	100 µg/mL: Ge, Mo, S, Si, Ti	125 mL	N9308541
20% HCl/ 1% HNO ₃	100 µg/mL: Au, Cr, Sb, Sn, Te	125 mL	N9308542
5% HNO ₃	100 µg/mL: Ag, As, B, Ba, Be, Bi, Ca, Cd, Co, Cu, Fe, K, Li, Mg, Mn, Na, Ni, P, Pb, Se, Sr, Tl, U, V, Zn	125 mL	N9308543
Multi-Element Solution 1			
2% HNO ₃	10 µg/mL: Be, Bi, Ce, Co, In, Mg, Ni, Pb, U	125 mL	N9300231
Multi-Element Solution 2			
5% HNO ₃	10 µg/mL: Ce, Dy, Er, Eu, Gd, Ho, La, Lu, Nd, Pr, Sc, Sm, Tb, Th, Tm, Y, Yb	125 mL	N9300232

Multi-Element Standards (con't)

Matrix	Contents	Vol.	Part No.
Multi-Element Solution 3			
5% HNO ₃	10 µg/mL: Ag, Al, As, Ba, Be, Bi, Ca, Cd, Co, Cr, Cs, Cu, Fe, Ga, Hg*, In, K, Li, Mg, Mn, Na, Ni, Pb, Rb, Se, Sr, Tl, U, V, Zn *Supplied in separate bottle.	125 mL	N9300233
Multi-Element Solution 3 without Mercury			N9301720
Multi-Element Solution 4			
10% HCl/1% HNO ₃	10 µg/mL: Au, Hf, Ir, Pd, Pt, Rh, Ru, Sb, Sn, Te	125 mL	N9300234
Multi-Element Solution 5			
H ₂ O/tr HF/ tr HNO ₃	10 µg/mL: B, Ge, Mo, Nb, P, Re, S, Si, Ta, Ti, W, Zr	125 mL	N9300234
Set of Multi-Element Solutions			
Includes: (1 bottle of each)			N9300236
	Multi-Element Solution 2	125 mL	N9300232
	Multi-Element Solution 3	125 mL	N9300233
	Multi-Element Solution 4	125 mL	N9300234
	Multi-Element Solution 5	125 mL	N9300235
	Water Blank	125 mL	N9303814
	Hydrochloric Acid Blank	125 mL	N9300238
	2% Nitric Acid Blank	125 mL	N9300239
PerkinElmer Pure I			
5% HNO ₃	400 µg/mL: Tl 200 µg/mL: Bi, In, Pb 150 µg/mL: Ga 100 µg/mL: Al 50 µg/mL: Ag, Ni 25 µg/mL: Cr 20 µg/mL: Cd, Co, Cu, Zn 15 µg/mL: B, Fe 5 µg/mL: Ba, Mn 1 µg/mL: Be, Sr	125 mL	N9303940
PerkinElmer Pure IV (Quality Control Standard 23)			
10% HNO ₃	1,000 µg/mL: Ag, Al, B, Ba, Bi, Ca, Cd, Co, Cr, Cu, Fe, Ga, In, K, Li, Mg, Mn, Na, Ni, Pb, Sr, Tl, Zn	125 mL	N9303941
PerkinElmer Pure VIII			
5% HNO ₃	100 µg/mL: Al, B, Ba, Be, Bi, Ca, Cd, Co, Cr, Cu, Fe, Ga, K, Li, Mg, Mn, Na, Ni, Pb, Se, Sr, Te, Tl, Zn	125 mL	N9303942
PerkinElmer Pure IX			
5% HNO ₃	100 µg/mL: As, Be, Pb, Cd	125 mL	N9303943
PerkinElmer Pure X			
2% HNO ₃	35,000 µg/mL: Ca 15,000 µg/mL: Mg 8,000 µg/mL: Na 3,000 µg/mL: K 100 µg/mL: B, Fe, Mo, Sr 50 µg/mL: As, Ba, Ni, V, Zn 30 µg/mL: Mn 25 µg/mL: Co, Pb 20 µg/mL: Be, Cd, Cr, Cu 10 µg/mL: Bi, Se, Tl 8 µg/mL Mercury in 5% HNO ₃	125 mL	N9303944

Multi-Element Standards (con't)

Matrix	Contents	Vol.	Part No.
8 µg/mL Mercury in 5% HNO₃			
5% HNO ₃	8 µg/mL: Hg	125 mL	N9303954
PerkinElmer Pure XI			
5% HNO ₃	2,500 µg/mL: Zn 900 µg/mL: Cr, Pb 800 µg/mL: Cu 200 µg/mL: Ni 10 µg/mL: Cd	125 mL	N9303945
5 µg/mL Mercury in 5% HNO₃			
5% HNO ₃	5 µg/mL: Hg in 5% HNO ₃	125 mL	N9303949
PerkinElmer Pure XIII			
5% HNO ₃	500 µg/mL: Al 250 µg/mL: V 100 µg/mL: As, Be, Co, Cr, Cu, Fe, Mn, Ni, Pb, Zn 25 µg/mL: Cd, Se	125 mL	N9303946
PerkinElmer Pure XVI (Quality Control Standard, 21 Elements)			
5% HNO ₃ / tr Tartaric Acid/ tr HF	100 µg/mL: As, Be, Ca, Cd, Co, Cr, Cu, Fe, Li, Mg, Mn, Mo, Ni, Pb, Sb, Se, Sr, Ti, Tl, V, Zn	125 mL	N9300281
PerkinElmer Pure XVII			
15% HCl/ trace HF	100 µg/mL: Hf, Ir, Sb, Sn, Ta, Tl, Zr	125 mL	N9303948
PerkinElmer Pure VI			
1 mol/L HNO ₃ / tr Tartaric Acid	10 µg/mL: Ag, Al, Ba, Bi, Cd, Co, Cr, Cu, Ga, K, Li, Mg, Mn, Mo, Na, Ni, Pb, Rb, Sr, Te, Tl, U, V 100 µg/mL: As, B, Be, Fe, Se, Zn 1000 µg/mL: Ca	125 mL	N9307741

Mixed Calibration Standards

Matrix	Contents	Vol.	Part No.
Mixed Calibration Standard			
2% HNO ₃	50 µg/mL: As, K 10 µg/mL: La, Li, Mn, Ni, Sr, Zn 1 µg/mL: Ba, Mg	500 mL	N0691579
Mixed Calibration Standard 1			
2% HNO ₃	500 µg/mL: Pb 200 µg/mL: Se 150 µg/mL: Cd, Zn 100 µg/mL: Mn 50 µg/mL: Be	125 mL	N9300200
Mixed Calibration Standard 2			
5% HNO ₃	10,000 µg/mL: Fe 100 µg/mL: Ba, Co, Cu, V	125 mL	N9300201
Mixed Calibration Standard 3			
2% HNO ₃ / tr HF	500 µg/mL: As 100 µg/mL: Mo, Si	125 mL	N9300202
Mixed Calibration Standard 4			
5% HNO ₃	1,000 µg/mL: Ca 400 µg/mL: K 200 µg/mL: Al, Na 20 µg/mL: Cr, Ni	125 mL	N9300203

Mixed Calibration Standards (con't)

Matrix	Contents	Vol.	Part No.
Mixed Calibration Standard 5			
5% HNO ₃ tr Tartaric Acid/ tr HF	1,000 µg/mL: Mg 200 µg/mL: Sb, Tl 100 µg/mL: B 50 µg/mL: Ag	125 mL	N9300204

Spike Standards

Matrix	Contents	Vol.	Part No.
Spike Sample Standard I			
5% HNO ₃ tr Tartaric Acid/ tr HF	200 µg/mL: Al, As, Ba, Se, Tl 100 µg/mL: Fe 50 µg/mL: Co, Mn, Ni, Pb, Sb, V, Zn	125 mL	N9300230
Spike Sample Standard I (water)			
5% HNO ₃ tr Tartaric Acid/ tr HF	500 µg/mL: Fe 250 µg/mL: Ba, Zn 100 µg/mL: Co, Cr, Cu, Mn, Ni, Sb, V 50 µg/mL: As, Pb 25 µg/mL: Ag, Be, Cd, Se, Tl	125 mL	N9303839
Spike Sample Standard 2 (soil)			
5% HNO ₃ tr Tartaric Acid/ tr HF	250 µg/mL: Ba, Cr, Cu, Zn 150 µg/mL: V 125 µg/mL: Ni 100 µg/mL: Co, Pb, Sb 50 µg/mL: As, Cd 25 µg/mL: Ag, Be, Se, Tl	125 mL	N9303840
Spike Sample Standard 3 (for ILM 05.2)			
5% HNO ₃ tr Tartaric Acid/ tr HF	200 µg/mL: Al, Ba 50 µg/mL: Co, Mn, Ni, V, Zn 25 µg/mL: Cu 20 µg/mL: Cr 10 µg/mL: Sb 5 µg/mL: Ag, Be, Cd, Tl 4 µg/mL: As 2 µg/mL: Pb 1 µg/mL: Se	125 mL	N9303841

Quality Control Standards

Matrix	Contents	Vol.	Part No.
Quality Control Standard 1A			
5% HNO ₃ /tr Tartaric Acid HF	1,000 µg/mL: Sb, Ti	125 mL	N9304130
Quality Control Standard 1B			
10% HNO ₃	1,000 µg/mL: As, Be, Ca, Cd, Co, Cr, Cu, Fe, Li, Mg, Mn, Mo, Ni, Pb, Se, Sr, Ti, Tl, V, Zn	125 mL	N9304131
Quality Control Standard, 21 Elements Pure (Pure XVI)			
5% HNO ₃ / tr Tartaric Acid/ tr HF	100 µg/mL: As, Be, Ca, Cd, Co, Cr, Cu, Fe, Li, Mg, Mn, Mo, Ni, Pb, Sb, Se, Sr, Ti, Tl, V, Zn	125 mL	N9300281
Quality Control Standard, 21 Elements Pure Plus			
5% HNO ₃ / tr Tartaric Acid/ tr HF	100 µg/mL: As, Be, Ca, Cd, Co, Cr, Cu, Fe, Li, Mg, Mn, Mo, Ni, Pb, Sb, Se, Sr, Ti, Tl, V, Zn	125 mL	N9303837
Quality Control Standard, 7A Elements			
5% HNO ₃ / tr HF	1,000 µg/mL: K 500 µg/mL: Si 100 µg/mL: Al, B, Ba, Na 50 µg/mL: Ag	125 mL	N9300280

MATRIX MODIFIERS AND AA TEST MIXES



We offer standards specifically for your Atomic Absorption (AA) instrument. From mixed standards to reagents, we have what you need for your AA analysis.

GFAAS Mixed Standard

Matrix	Contents	Vol.	Part No.
5% HNO ₃ w/trace HF	100 µg/mL: Al, As, Pb, Sb, Se, Tl 50 µg/mL: Ba, Co, Cu, Ni 20 µg/mL: Cr, Fe, Mn 10 µg/mL: Ag 5 µg/mL: Be, Cd	125 mL	N9300244

AA Test Mix

Matrix	Contents	Vol.	Part No.
2% HCl	50 µg/mL: Ca, Cr, Cu, Fe, Ni 20 µg/mL: K 10 µg/mL: Na, Zn	125 mL	02900540

Matrix Modifiers for Graphite Furnace AA

Matrix	Contents	Vol.	Part No.
Mg(NO ₃) ₂	1% Mg (NO ₃) ₂ (as nitrate)	100 mL	B0190634
Pd	1% Pd (as nitrate)	50 mL	B0190635
NH ₄ H ₂ PO ₄	10% NH ₄ H ₂ PO ₄	100 mL	N9303445

Reagents

Description	Vol.	Part No.
Triton® X-100 Wetting Agent	100 mL	N9300260
Antifoaming Silicone Emulsion	500 mL	B0507226
Glycerol	1 L	B3141064

Order your FREE PerkinElmer Pure Standards Periodic Table Poster

Our standards periodic table poster is a great addition to any lab. Aside from its modern design,

we provide you with more than just a table of elements. In order to make a better periodic table, we highlighted all the elements for which we offer standards for, increasing the functionality and utility of the poster.

Go to www.perkinelmer.com/periodic and fill out the form to receive your standards periodic table poster.

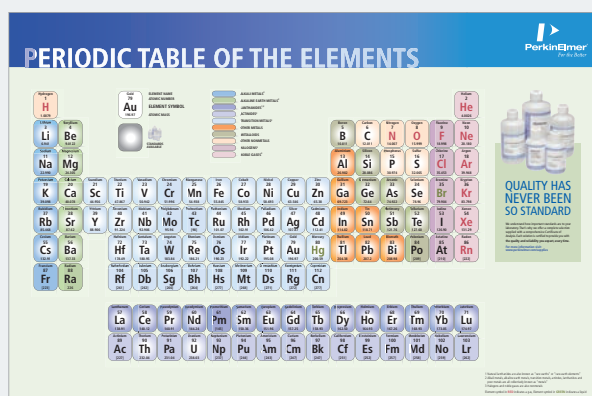

ENVIRONMENTAL ANALYSIS STANDARDS



We offer a variety of environmental analysis standards for all your environmental application needs.

Environmental Method Sets

Matrix	Contents	Vol.	Part No.
Environmental Standard Kit for NexION Standard Mode			N9307118
1 bottle each:			
5% HNO ₃	1,000 µg/mL: Ca, K, Mg, Na	125 mL	N9307805
5% HNO ₃	1,000 µg/mL: Al, Fe	125 mL	N9307806
5% HNO ₃ / tr Tartaric Acid/ tr HF	100 µg/mL: Ag, Al, As, Ba, Be, Ca, Cd, Co, Cr, Cu, Fe, K, Mg, Mn, Mo, Na, Ni, Pb, Sb, Se, Sn, Sr, Ti, Tl, V, Zn	125 mL	N9301721
2% HNO ₃	100 µg/mL: B, Th, U	125 mL	N9307807
5% HNO ₃	10 µg/mL: Hg	125 mL	N9300253
2% HNO ₃	50 µg/mL: Sc, Ge 10 µg/mL: Rh, In, Tb	125 mL	N9308591
Environmental Standard Kit for NexION KED/DRC Mode			N9307119
1 bottle each:			
5% HNO ₃	1,000 µg/mL: Ca, K, Mg, Na	125 mL	N9307805
5% HNO ₃	1,000 µg/mL: Al, Fe	125 mL	N9307806
5% HNO ₃ / tr Tartaric Acid/ tr HF	100 µg/mL: Ag, Al, As, Ba, Be, Ca, Cd, Co, Cr, Cu, Fe, K, Mg, Mn, Mo, Na, Ni, Pb, Sb, Se, Sn, Sr, Ti, Tl, V, Zn	125 mL	N9301721
2% HNO ₃	100 µg/mL: B, Th, U	125 mL	N9307807
5% HNO ₃	10 µg/mL: Hg	125 mL	N9300253
2% HNO ₃	100 µg/mL: Sc 50 µg/mL: Ge 1 µg/mL: Rh, In, Tb	125 mL	N9308592

Environmental Method Sets (con't)

Matrix	Contents	Vol.	Part No.
Environmental Standard Kit for ELAN non-DRC/ Standard ICP-MS Instruments			N9307111
1 bottle each:			
5% HNO ₃	1,000 µg/mL: Ca, K, Mg, Na	125 mL	N9307805
5% HNO ₃	1,000 µg/mL: Al, Fe	125 mL	N9307806
5% HNO ₃ / tr Tartaric Acid/ tr HF	100 µg/mL: Ag, Al, As, Ba, Be, Ca, Cd, Co, Cr, Cu, Fe, K, Mg, Mn, Mo, Na, Ni, Pb, Sb, Se, Sn, Sr, Ti, Tl, V, Zn	125 mL	N9301721
2% HNO ₃	100 µg/mL: B, Th, U	125 mL	N9307807
5% HNO ₃	10 µg/mL: Hg	125 mL	N9300253
Internal Standard Mix			
5% HNO ₃ / tr HCL	50 µg/mL: Sc 20 µg/mL: Ge 10 µg/mL: In, Ir, Li6, Rh, Tb, Y	125 mL	N9307808
Environmental Standard Kit for ELAN DRC Instruments			N9307112
1 bottle each:			
5% HNO ₃	1,000 µg/mL: Ca, K, Mg, Na	125 mL	N9307805
5% HNO ₃	1,000 µg/mL: Al, Fe	125 mL	N9307806
5% HNO ₃ / tr Tartaric Acid/ tr HF	100 µg/mL: Ag, Al, As, Ba, Be, Ca, Cd, Co, Cr, Cu, Fe, K, Mg, Mn, Mo, Na, Ni, Pb, Sb, Se, Sn, Sr, Ti, Tl, V, Zn	125 mL	N9301721
2% HNO ₃	100 µg/mL: B, Th, U	125 mL	N9307807
5% HNO ₃	10 µg/mL: Hg	125 mL	N9300253
5% HNO ₃ / tr HCL	Internal Standard Mix 200 µg/mL: Sc 20 µg/mL: Ga 10 µg/mL: In, Ir, Rh, Tm	125 mL	N9307738
Contract Lab Program Modification Set			N9307103
1 bottle each:			
2% HNO ₃ / 5% HCl	10 µg/mL: Ba, Be, Ce, Co, In, Li, Mg, Pb, Rh, Tl, U, Y	125 mL	N9303843
2% HNO ₃ / tr Tartaric Acid/ tr HF	20 µg/mL: Ag, Al, As, Ba, Be, Cd, Co, Cr, Cu, Mn, Mo, Ni, Pb, Sb, Se, Th, Tl, U, V, Zn	125 mL	N9303816
5% HNO ₃ / tr Tartaric Acid/ tr HF	100 µg/mL: Ag, Al, As, Ba, Be, Ca, Cd, Co, Cr, Cu, Fe, K, Mg, Mn, Mo, Na, Ni, Pb, Sb, Se, Sn, Sr, Ti, Tl, V, Zn	125 mL	N9301721
5% HNO ₃ / tr Tartaric Acid	500 µg/mL: Ca, K, Mg, Na 20 µg/mL: Al, Ba 10 µg/mL: Fe 6 µg/mL: Sb 5 µg/mL: Co, V 4 µg/mL: Ni 2.5 µg/mL: Cu 2 µg/mL: Zn 1.5 µg/mL: Mn 1 µg/mL: Ag, As, Cr, Tl 0.5 µg/mL: Be, Cd, Se 0.3 µg/mL: Pb	125 mL	N9303819
2% HNO ₃ / tr Tartaric Acid/ tr HF	10 µg/mL: Ag, Al, As, Ba, Be, Cd, Co, Cr, Cu, Mn, Ni, Pb, Sb, Se, Tl, V, Zn	125 mL	N9303821
5% HNO ₃	10 µg/mL: Hg	125 mL	N9300253
2% HNO ₃	200 µg/mL: Ca, Fe, K, Mg, Na		N9303822
2% HNO ₃	10 µg/mL: Mo, Th, U		N9303823
2% HNO ₃ / tr HF	10 µg/mL: Mo, Sn, Sr, Ti	125 mL	N9303824

Environmental Method Sets (con't)

Matrix	Contents	Vol.	Part No.
5% HNO ₃ / tr HF	21,215 µg/mL: Cl 3,000 µg/mL: Ca 2,500 µg/mL: Fe, Na 2,000 µg/mL: C 1,000 µg/mL: Al, K, Mg, P, S 20 µg/mL: Mo, Ti	125 mL	N9303827
2% HNO ₃	20 µg/mL: Co, Cr, Cu, Mn, Ni, V 10 µg/mL: As, Cd, Se, Zn 5 µg/mL: Ag	125 mL	N9303829
5% HNO ₃ / tr Tartaric Acid/ tr HF	500 µg/mL: Fe 250 µg/mL: Ba, Zn 100 µg/mL: Co, Cr, Cu, Mn, Ni, Sb, V 50 µg/mL: As, Pb 25 µg/mL: Ag, Be, Cd, Se, Ti	125 mL	N9303839
5% HNO ₃ / tr Tartaric Acid/ tr HF	250 µg/mL: Ba, Cr, Cu, Zn 150 µg/mL: V 125 µg/mL: Ni 100 µg/mL: Co, Pb, Sb 50 µg/mL: As, Cd 5 µg/mL: Ag, Be, Se, Ti	125 mL	N9303840
5% HNO ₃	1,000 µg/mL: Al, Ca, Fe, K, Mg, Na 20 µg/mL: Ag, As, Ba, Be, Cd, Co, Cr, Cu, Mn, Ni, Pb, Se, Ti, V, Zn	125 mL	N9303835
H ₂ O/tr HF	7,200 µg/mL: Cl 2,000 µg/mL: C 1,000 µg/mL: P, S 20 µg/mL: Mo, Sb, Ti	125 mL	N9303836
Calibration Standards Set for Method 6010			N9307104
1 bottle each:			
5% HNO ₃	5,000 µg/mL: Ca, K, Mg, Na	125 mL	N9300218
5% HNO ₃	400 µg/mL: Ni 200 µg/mL: Zn 150 µg/mL: Mn 100 µg/mL: Ag, Cr	125 mL	N9300219
5% HNO ₃	2,000 µg/mL: Al, Ba 1,000 µg/mL: Fe 500 µg/mL: Co, V 250 µg/mL: Cu 50 µg/mL: Be	125 mL	N9300220
5% HNO ₃	100 µg/mL: As, Tl 50 µg/mL: Cd, Pb, Se	125 mL	N9300221
H ₂ O/tr HF	10 µg/mL: B, Ge, Mo, Nb, P, Re, S, Si, Ta, Ti, W, Zr	125 mL	N9300235
2% HNO ₃	1,000 µg/mL: Li	500 mL	N9300129
2% HNO ₃	1,000 µg/mL: Sb	500 mL	N9300101
2% HNO ₃	1,000 µg/mL: Sr	500 mL	N9300153
20% HNO ₃	1,000 µg/mL: Sn	500 mL	N9300161
2% HNO ₃	1,000 µg/mL: Cr	500 mL	N9300112
2% HNO ₃	1,000 µg/mL: Cu	500 mL	N9300114
2% HNO ₃	1,000 µg/mL: Mn	500 mL	N9300132
2% HNO ₃	1,000 µg/mL: Ni	500 mL	N9300136
H ₂ O/tr HF	1,000 µg/mL: Ti	500 mL	N9300162
2% HNO ₃	1,000 µg/mL: V	500 mL	N9300165
2% HNO ₃	1,000 µg/mL: Al	500 mL	N9300100
2% HNO ₃	1,000 µg/mL: Ca	500 mL	N9300108
2% HNO ₃	1,000 µg/mL: Fe	500 mL	N9300126
2% HNO ₃	1,000 µg/mL: Mg	500 mL	N9300131

Environmental Method Sets (con't)

Matrix	Contents	Vol.	Part No.
Internal Standard Set for Method 6010 & 200.7			N9307105
1 bottle each:			
2% HNO ₃	1,000 µg/mL: Y	500 mL	N9300167
2% HNO ₃	1,000 µg/mL: Sc	500 mL	N9300148
Interference Solutions for Method 6010			N9307106
1 bottle each:			
2% HNO ₃	1,000 µg/mL: Al	125 mL	N9300184
2% HNO ₃	1,000 µg/mL: Ca	500 mL	N9300108
2% HNO ₃	1,000 µg/mL: Mg	125 mL	N9300179
2% HNO ₃	1,000 µg/mL: Fe	500 mL	N9300126
2% HNO ₃	1,000 µg/mL: K	500 mL	N9300141
2% HNO ₃	1,000 µg/mL: Na	500 mL	N9300152
2% HNO ₃	1,000 µg/mL: Cr	500 mL	N9300112
2% HNO ₃	1,000 µg/mL: Cu	500 mL	N9300114
2% HNO ₃	1,000 µg/mL: Mn	500 mL	N9300132
2% HNO ₃	1,000 µg/mL: Ni	500 mL	N9300136
H ₂ O/tr HF	1,000 µg/mL: Ti	500 mL	N9300162
2% HNO ₃	1,000 µg/mL: V	500 mL	N9300165
5% HNO ₃	5,000 µg/mL: Al, Ca, Mg 2,000 µg/mL: Fe	500 mL	N9300226
5% HNO ₃ / tr Tart-HF	100 µg/mL: Cd, Ni, Zn 60 µg/mL: Sb 50 µg/mL: Ba, Be, Co, Cr, Cu, Mn, V 20 µg/mL: Ag 10 µg/mL: As, Tl 5 µg/mL: Pb, Se	125 mL	N9300227
5% HNO ₃	1,000 µg/mL: Cr, Cu, Mn, Ni, Ti, V	500 mL	N9300228
5% HNO ₃ / tr Tartaric Acid/ tr HF	100 µg/mL: Al, As, B, Mo, Na, Sb, Se, Tl 10 µg/mL: Ca, Fe, Mg, Si	125 mL	N9300229
Calibration Standards for Method 200.7			N9307107
5% HNO ₃	5,000 µg/mL: Ca, K, Mg, Na	125 mL	N9300218
5% HNO ₃	400 µg/mL: Ni 200 µg/mL: Zn 150 µg/mL: Mn 100 µg/mL: Ag, Cr	125 mL	N9300219
5% HNO ₃	2,000 µg/mL: Al, Ba 1,000 µg/mL: Fe 500 µg/mL: Co, V 250 µg/mL: Cu 50 µg/mL: Be	125 mL	N9300220
5% HNO ₃	100 µg/mL: As, Tl 50 µg/mL: Cd, Pb, Se	125 mL	N9300221
H ₂ O/tr HF	10 µg/mL: B, Ge, Mo, Nb, P, Re, S, Si, Ta, Ti, W, Zr	125 mL	N9300235
2% HNO ₃	1,000 µg/mL: Li	500 mL	N9300129
2% HNO ₃	1,000 µg/mL: Sb	500 mL	N9300101
2% HNO ₃	1,000 µg/mL: Sr	500 mL	N9300153
20% HNO ₃	1,000 µg/mL: Sn	500 mL	N9300161

Environmental Method Sets (con't)

Matrix	Contents	Vol.	Part No.
Interference Solutions for Method 200.7			N9307108
2% HNO ₃	1,000 µg/mL: Al	125 mL	N9300184
2% HNO ₃	1,000 µg/mL: Ca	500 mL	N9300108
2% HNO ₃	1,000 µg/mL: Mg	125 mL	N9300179
2% HNO ₃	1,000 µg/mL: Fe	500 mL	N9300126
2% HNO ₃	1,000 µg/mL: K	500 mL	N9300141
2% HNO ₃	1,000 µg/mL: Na	500 mL	N9300152
5% HNO ₃	5,000 µg/mL: Al, Ca, Mg 2,000 µg/mL: Fe	500 mL	N9300226
5% HNO ₃ / tr Tart-HF	100 µg/mL: Cd, Ni, Zn 60 µg/mL: Sb 50 µg/mL: Ba, Be, Co, Cr, Cu, Mn, V 20 µg/mL: Ag 10 µg/mL: As, Tl 5 µg/mL: Pb, Se	125 mL	N9300227
Environmental EPA Set 1			N9307110
2% HNO ₃	500 µg/mL: Pb 200 µg/mL: Se 150 µg/mL: Cd, Zn 100 µg/mL: Mn 50 µg/mL: Be	125 mL	N9300200
5% HNO ₃	10,000 µg/mL: Fe 100 µg/mL: Ba, Co, Cu, V	125 mL	N9300201
2% HNO ₃ / tr HF	500 µg/mL: As 100 µg/mL: Mo, Si	125 mL	N9300202
5% HNO ₃	1,000 µg/mL: Ca 400 µg/mL: K 200 µg/mL: Al, Na 20 µg/mL: Cr, Ni	125 mL	N9300203
5% HNO ₃ / tr Tart-HF	1,000 µg/mL: Mg 200 µg/mL: Sb, Tl 100 µg/mL: B 50 µg/mL: Ag	125 mL	N9300204
5% HNO ₃	20,000 µg/mL: K 1,000 µg/mL: As, Pb, Tl 500 µg/mL: Se 300 µg/mL: Ag, Ba, Cd, Co, Cr, Cu, Ni, V, Zn 200 µg/mL: Mn 100 µg/mL: Be	125 mL	N9300205
5% HNO ₃	100 µg/mL: Hg	125 mL	N9300223
5% HNO ₃	6,000 µg/mL: Ca 5,000 µg/mL: Fe 3,000 µg/mL: Mgs 1,200 µg/mL: Al 1,000 µg/mL: Na	125 mL	N9300208
H ₂ O/tr HNO ₃ / 0.6% Tartaric Acid	1,000 µg/mL: Sb	125 mL	N9300207
5% HNO ₃	ASTM® Type I Water	500 mL	N9307809
5% HCl	ASTM® Type I Water	500 mL	N9307810
Environmental EPA Set 2			N9307109
2% HNO ₃	500 µg/mL: Pb 200 µg/mL: Se 150 µg/mL: Cd, Zn 100 µg/mL: Mn 50 µg/mL: Be	125 mL	N9300200
5% HNO ₃	10,000 µg/mL: Fe 100 µg/mL: Ba, Co, Cu, V	125 mL	N9300201
2% HNO ₃ / tr HF	500 µg/mL: As 100 mg/mL: Mo, Si	125 mL	N9300202

Matrix	Contents	Vol.	Part No.
5% HNO ₃	1,000 µg/mL: Ca 400 µg/mL: K 200 µg/mL: Al, Na 20 µg/mL: Cr, Ni	125 mL	N9300203
5% HNO ₃ / tr Tart-HF	1,000 µg/mL: Mg 200 µg/mL: Sb, Tl 100 µg/mL: B 50 µg/mL: Ag	125 mL	N9300204
5% HNO ₃	20,000 µg/mL: K 1,000 µg/mL: As, Pb, Tl 500 µg/mL: Se 300 µg/mL: Ag, Ba, Cd, Co, Cr, Cu, Ni, V, Zn 200 µg/mL: Mn 100 µg/mL: Be	125 mL	N9300205
5% HNO ₃	6,000 µg/mL: Ca 5,000 µg/mL: Fe 3,000 µg/mL: Mgs 1,200 µg/mL: Al 1,000 µg/mL: Na	125 mL	N9300208
H ₂ O/tr HNO ₃ / 0.6% Tartaric Acid	1,000 µg/mL: Sb	125 mL	N9300207
5% HNO ₃	ASTM® Type I Water	500 mL	N9307809
5% HCL	ASTM® Type I Water	500 mL	N9307810

Water Pollutant Standards

Matrix	Contents	Vol.	Part No.
Primary Drinking Water Metals			
2% HNO ₃	100 µg/mL: Ba 10 µg/mL: Ag, As, Cr, Hg*, Pb 5 µg/mL: Cd, Se	125 mL	N9300216
Secondary Drinking Water Metals			
2% HNO ₃	500 µg/mL: Zn 100 µg/mL: Cu 30 µg/mL: Fe 5 µg/mL: Mn	125 mL	N9300217
Trace Metals I			
5% HNO ₃	500 µg/mL: Al 250 µg/mL: V 100 µg/mL: As, Be, Co, Cr, Cu, Fe Mn, Ni, Pb, Zn 25 µg/mL: Cd, Se 10 µg/mL: Hg*	125 mL	N9300211
*Supplied in separate bottle.			
Trace Metals II			
2% HNO ₃	20 µg/mL: Sb, Tl 10 µg/mL: Ag	125 mL	N9300212
Trace Metals III			
2% HNO ₃	500 µg/mL: Ba, Ca, Mo, Na 100 µg/mL: K, Mg	125 mL	N9300213
Alternate Metals I			
2% HNO ₃	20 µg/mL: Al, Fe, V 10 µg/mL: Co, Cu, Mn, Ni, Zn 5 µg/mL: Be, Sb, Tl	125 mL	N9300214
Alternate Metals II			
2% HNO ₃	500 µg/mL: Ca, Na 100 µg/mL: K, Mg	125 mL	N9300215
Alternate Metals II			
2% HNO ₃	500 µg/mL: Ca, Na 100 µg/mL: K, Mg	500 mL	N9303952

Toxicity Characteristic Leachate Procedure (TCLP) Standard

Matrix	Contents	Vol.	Part No.
TCLP Standard 1			
2% HNO ₃	500 µg/mL: Ba 25 µg/mL: Ag, As, Cr, Pb 100 µg/mL: Hg* 5 µg/mL: Cd, Se <small>*Supplied in separate bottle.</small>	500 mL	N9300241

PHARMACEUTICAL ANALYSIS STANDARDS



USP Standards

As a part of our United States Pharmacopeia (USP) compliant offering, we provide calibration and check standards for the analysis of metals in drugs, pharmaceutical substances and raw materials to verify Oral Daily Dose PDE, Parenteral Component Limit and Parenteral Daily Dose PDE.

Our trace metal USP standards can be used to calibrate Arsenic, Cadmium, Lead and Mercury, the four toxic metals as part of the USP regulations. When you couple our accurate and reliable USP standards with your ICP-MS you will remain compliant with the new and changing regulations.

ICH Standards

In conjunction with our United States Pharmacopeia (USP) calibration standards, we offer six calibration standards for the analysis of metals in pharmaceutical materials and products following the International Conference on Harmonization (ICH) guidelines.

The ICH standards verify Elemental Impurities, Precious Metals Impurities and Parenteral Elemental Impurities. Couple our accurate and reliable ICH standards with your ICP-MS and you will remain compliant with the new and changing regulations.

USP AND ICH STANDARDS

Description	Matrix	Contents	Vol.	Part No.
USP Oral Elemental Impurities A (Big 4)	5% HNO ₃	25 mg/kg: Cd 15 mg/kg Hg 5 mg/kg Pb 1.5 mg/kg As	125 mL	N9304150
USP Precious Metal Impurities B (with Os)	15% HCl	100 mg/kg: Ir, Pd, Pt, Rh, Ru, Os	125 mL	N9304151
USP Precious Metals Impurities B	15% HCl	100 mg/kg: Ir, Pd, Pt, Rh, Ru	125 mL	N9304152
USP Oral /Parenteral Elemental Impurities C	5% HNO ₃	1000 mg/kg: Cu 500 mg/kg Ni 100 mg/kg Mo, V	125 mL	N9304153
USP Parenteral Elemental Impurities D (Big 4)	5% HNO ₃	5 mg/kg: Pb 2.5 mg/kg Cd 1.5 mg/kg As, Hg	125 mL	N9304154
USP Dietary Supplement Metal Impurities	5% HNO ₃	15 mg/kg: As 5 mg/kg Pb 2.5 mg/kg Cd 1.5 mg/kg Hg	125 mL	N8145322
USP Inhalation Metal Impurities A	5% HNO ₃	1.5 mg/kg: As, Cd, Hg, 5 mg/kg Pb,	125 mL	N8145323
USP Inhalation Metal Impurities B	5% HNO ₃	250 mg/kg: Mo 70 mg/kg Cu 30 mg/kg V 25 mg/kg Cr, 1.5 mg/kg Ni	125 mL	N8145324
ICH Oral Elemental Impurities A (Big 4)	5% HNO ₃	25 mg/kg: Cd 15 mg/kg Hg 5 mg/kg Pb 1.5 mg/kg As	125 mL	N9304155
ICH Precious Metal Impurities B (with Os)	15% HCl	100 mg/kg: Ir, Pd, Pt, Rh, Ru, Os	125 mL	N9304156
ICH Precious Metals Impurities B	15% HCl	100 mg/kg: Ir, Pd, Pt, Rh, Ru	125 mL	N9304157
ICH Parenteral Elemental Impurities D (Big 4)	5% HNO ₃	5 mg/kg: Pb 2.5 mg/kg Cd 1.5 mg/kg As, Hg	125 mL	N9304158
Global/ICH Elemental Impurities E	5% HNO ₃	2500 mg/kg: Mn 1000 mg/kg Cu 250 mg/kg Cr, Ni 100 mg/kg Co, Mo, V	125 mL	N9304159
Global/ICH Elemental Impurities F	5% HNO ₃	13,000 mg/kg: Fe, Zn	125 mL	N9304160



GOLD NANOPARTICLE STANDARDS

Description	Diam (nm)	Number of Particles/mL	Vol. (mL)	Part No.
30 nm Spherical Au Nanoparticle in DI Water	30	2.00E+11	25	N8142300
40 nm Spherical Au Nanoparticle in DI Water	40	8.70E+10	25	N8142301
50 nm Spherical Au Nanoparticle in DI Water	50	4.50E+10	25	N8142302
60 nm Spherical Au Nanoparticle in DI Water	60	2.60E+10	25	N8142303
70 nm Spherical Au Nanoparticle in DI Water	70	1.60E+10	25	N8142304
80 nm Spherical Au Nanoparticle in DI Water	80	1.10E+10	25	N8142305
90 nm Spherical Au Nanoparticle in DI Water	90	7.80E+09	25	N8142306
100 nm Spherical Au Nanoparticle in DI Water	100	5.70E+09	25	N8142307

INSTRUMENT SET-UP AND CALIBRATION STANDARDS



From instrument installation to instrument calibration, we provide quality set-up, check and calibration standards to ensure instrument performance.

Instrument Calibration Standards

Matrix	Contents	Vol.	Part No.
Instrument Calibration Standard 1			
5% HNO ₃ / tr Tartaric Acid	20 µg/mL: Ag, Al, As, Ba, Be, Cd, Co, Cr, Cu, Mn, Mo, Ni, Pb, Sb, Se, Th, Tl, U, V, Zn	125 mL	N9303816
Instrument Calibration Standard 2			
5% HNO ₃ / tr Tartaric Acid/ tr HF	100 µg/mL: Ag, Al, As, Ba, Be, Ca, Cd, Co, Cr, Cu, Fe, K, Mg, Mn, Mo, Na, Ni, Pb, Sb, Se, Sn, Sr, Ti, Tl, V, Zn	125 mL	N9301721
Instrument Calibration Standard 3			
5% HNO ₃	1,000 µg/mL: Ca, Fe, K, Mg, Na	125 mL	N9303818
Initial Calibration Verification Standard 1			
5% HNO ₃ / tr Tartaric Acid	1,000 µg/mL: Ca, Fe, K, Mg, Na, Sr 10 µg/mL: Ag, Al, As, Ba, Be, Cd, Co, Cr, Cu, Mn, Mo, Ni, Pb, Sb, Se, Ti, V, Zn, Th, U	125 mL	N9303825
Initial Calibration Verification Standard 2			
2% HNO ₃ / tr HF	10 µg/mL: Sn, Ti	125 mL	N9303826
ELAN® 6100 DRC Setup/Stab/Masscal Solution			
0.5% HNO ₃	10 µg/L: Ba 1 µg/L: Al, Cd, Ce, Cr, Cu, In, Pb, Mg, Mn, Rh, Th	1,000 mL	N8125035
ELAN DRC/DRCplus/DRC II Solution Kit			
Solution Kit (Includes items listed below)			N8120541
2 x 1,000 mL: Setup/Stability/Masscal Solution			N8125035
2 x 250 mL: Wash Solution			N8125033
1 x 250 mL: Sensitivity/Detection Limit Solution			N8125034
1 x 125 mL: Methanol Blank Solution			N8125037
1 x 125 mL: Chromium in Methanol Solution			N8125038

Instrument Calibration Standards (con't)

Matrix	Contents	Part No.
ELAN 9000/6100 Solution Kit		
2 x 1,000 mL: Setup/Stability/Masscal Solution		N8125030
1 x 125 mL: Dual-Detector		N8125010
1 x 1,000 mL: Wash Solution		N8122038
1 x 250 mL: Detection Limit Solution		N8125031
ELAN 9000/6100 Setup/Stability/Masscal Solution		
1% HNO ₃	10 µg/L: Ba, Cd, Ce, Cu, In, Pb, Mg, Rh, U	1,000 mL N8125030
ELAN 9000/6x00 Dual-Detector Calibration Solution		
1% HNO ₃	200 µg/L: Cd, Cu, Pb, Mg, Rh	125 mL N8125032
ELAN 6000/5000 Plasma Setup Solution		
2% HNO ₃	10 µg/L: Ba, Cd, Ce, Cu, Ge, Rh, Sc, Pb, Mg, Rh, Sc, Tb, Tl	1,000 mL N8122014
ELAN 5000 Detection Limit Solution		
2% HNO ₃	10 µg/L: Be, Co, Ge, In, Tl, U	125 mL N8122017

SmartTune Standards

Matrix	Contents	Vol.	Part No.
SmartTune Solution for Standard ELANs/DRC-e			
1% HNO ₃	10 µg/L: Ba, Be, Ce, Co, In, Pb, Mg, Rh, U	1,000 mL	N8125040
SmartTune Solution for DRC/DRCplus/DRC II			
0.5% HNO ₃	10 µg/L: Ba 1 µg/L: Be, Ce, Co, In, Fe, Pb, Mg, Th, U	1,000 mL	N8125041
Tuning Solution 1			
2% HNO ₃ / 5% HCL	10 µg/mL: Ba, Be, Ce, Co, In, Li, Mg, Pb, Rh, Tl, U, Y	125 mL	N9303843
NexION Setup Solution			
1% HNO ₃	1 µg/L: Be, Ce, Fe, In, Li, Mg, Pb, U	500 mL	N8145051
1% HNO ₃	10 µg/L: Be, Ce, Fe, In, Li, Mg, Pb, U	500 mL	N8145284

Instrument Setup Solutions

Matrix	Contents	Vol.	Part No.
Vis Wavecal Solution			
2% HNO ₃	50 µg/mL: K 10 µg/mL: La, Li, Mn, Na, Sr 1 µg/mL: Ba, Ca	250 mL	N9302946
UV Wavecal Solution			
5% HCL	100 µg/mL: K, P, S 20 µg/mL: As, La, Li, Mn, Mo, Na, Mo, Na, Ni, Sc	250 mL	N0681470
5% HCL	100 µg/mL: K, P, S 20 µg/mL: As, La, Li, Mn, Mo, Na, Ni, Sc 1 µg/mL: Ca	500 mL	N0582152
Low UV Standard			
2% HNO ₃	10 µg/mL: Al, P, S	250 mL	N0691580
Calcium Stray Light Standard			
H ₂ O	10,000 µg/mL: Ca	125 mL	N0691581
1% HNO ₃	10 µg/L: Be, Ce, Fe, In, Li, Mg, Pb, U	500 mL	N8145284

Initial Calibration Verification Standards

Matrix	Contents	Vol.	Part No.
5% HNO ₃ / tr Tartaric Acid	500 µg/mL: Ca, K, Mg, Na 200 µg/mL: Al, Ba 100 µg/mL: Fe 60 µg/mL: Sb 50 µg/mL: Co, V 40 µg/mL: Ni 25 µg/mL: Cu 20 µg/mL: Zn 15 µg/mL: Mn 10 µg/mL: Ag, As, Cr, Tl 5 µg/mL: Be, Cd, Se 3 µg/mL: Pb	500 mL	N9300224
5% HNO ₃ / tr Tartaric Acid	500 µg/mL: Ca, K, Mg, Na 200 µg/mL: Al, Ba 100 µg/mL: Fe 60 µg/mL: Sb 50 µg/mL: Co, V 40 µg/mL: Ni 25 µg/mL: Cu 20 µg/mL: Zn 15 µg/mL: Mn 10 µg/mL: Ag, As, Cr, Tl 5 µg/mL: Be, Cd, Se 3 µg/mL: Pb	125 mL	N9303953

Instrument Calibration Standards for CLP

Matrix	Contents	Vol.	Part No.
Instrument Calibration Standard 1			
5% HNO ₃	5,000 µg/mL: Ca, K, Mg, Na	125 mL	N9300218
Instrument Calibration Standard 2			
5% HNO ₃	400 µg/mL: Ni 200 µg/mL: Zn 150 µg/mL: Mn 100 µg/mL: Ag, Cr	125 mL	N9300219
Instrument Calibration Standard 3			
5% HNO ₃	2,000 µg/mL: Al, Ba 1,000 µg/mL: Fe 500 µg/mL: Co, V 250 µg/mL: Cu 50 µg/mL: Be	125 mL	N9300220
Instrument Calibration Standard 4			
5% HNO ₃	100 µg/mL: As, Tl 50 µg/mL: Cd, Se 30 µg/mL: Pb	125 mL	N9300221

Instrument Check Standards

Matrix	Contents	Vol.	Part No.
Instrument Check Standard 1			
2% HNO ₃ / tr Tartaric Acid/ tr HF	10 µg/L: Ba 1 µg/L: Be, Ce, Co, In, Fe, Pb, Mg, Co, Cr, Cu, Mn, Ni, Pb, Sb, Se, Tl, V, Zn	125 mL	N9303821
Instrument Check Standard 3			
2% HNO ₃	200 µg/mL: Ca, Fe, K, Mg, Na	125 mL	N9303822
Instrument Check Standard 4			
2% HNO ₃	10 µg/mL: Mo, Th, U	125 mL	N9303823
Instrument Check Standard 5			
2% HNO ₃ / tr HF	10 µg/mL: Mo, Sn, Sr, Ti	125 mL	N9303824

Interference Check Standards

Matrix	Contents	Vol.	Part No.
Interference Check Standard 1			
H ₂ O/tr HNO ₃ / 0.6% Tartaric Acid	1,000 µg/mL: Sb	125 mL	N9300207
Interference Check Standard 5			
5% HNO ₃	6,000 µg/mL: Ca 5,000 µg/mL: Fe 3,000 µg/mL: Mg 1,200 µg/mL: Al 1,000 µg/mL: Na	125 mL	N9300208
Interference Check Standard 18			
5% HNO ₃	20,000 µg/mL: K 1,000 µg/mL: As, Pb, Tl 500 µg/mL: Se 300 µg/mL: Ag, Ba, Cd, Co, Cr, Cu, Ni, V, Zn 200 µg/mL: Mn 100 µg/mL: Be, Hg*	125 mL	N9300205
Interferents A			
5% HNO ₃	5,000 µg/mL: Al, Ca, Mg 2,000 µg/mL: Fe	500 mL	N9300226
Alternate Interferents A			
5% HNO ₃	1,000 µg/mL: Cr, Cu, Mn, Ni, Ti, V	500 mL	N9300228
Analytes B			
5% HNO ₃ / tr Tartaric Acid/ tr HF	100 µg/mL: Cd, Ni, Zn 60 µg/mL: Sb 50 µg/mL: Ba, Be, Co, Cr, Cu, Mn, V 20 µg/mL: Ag 10 µg/mL: As, Tl 5 µg/mL: Pb, Se	125 mL	N9300227
Alternate Analytes B			
5% HNO ₃ / tr Tartaric Acid/ tr HF	100 µg/mL: Al, As, B, Mo, Na, Sb, Se, Tl 10 µg/mL: Ca, Fe, Mg, Si	125 mL	N9300229
Interference Check Standards			
H ₂ O/tr HNO ₃ / 0.6% Tartaric Acid	1,000 µg/mL: Sb	500 mL	N9303797
Interference Check Solution 1 (for SW-846 & ILM 05.2)			
5% HNO ₃ / tr HF	10,000 µg/mL: Cl 2,000 µg/mL: C 1,000 µg/mL: Al, Ca, Fe, K, Mg, Na, P, S 20 µg/mL: Mo, Ti	125 mL	N9303828
Interference Check Solution 2 (for SW-846)			
2% HNO ₃	10 µg/mL: Ag, As, Cd, Co, Cr, Cu, Mn, Ni, Zn	125 mL	N9303830
Analytes C (for ILM 05.2)			
2% HNO ₃ / tr Tartaric Acid/ tr HF	2 µg/mL: Ag, As, Ba, Be, Cd, Co, Cr, Cu, Hg*, Mn, Ni, Pb, Sb, Se, Tl, V, Zn	125 mL	N9303831

*Supplied in separate bottle.

Internal Standard Solutions

Matrix	Contents	Vol.	Part No.
Multi-Element Internal Standard			
2% HNO ₃	10 µg/mL: Bi, Ho, In, Li6, Sc, Tb, Y	125 mL	N9303834
Internal Standard Mix			
5-10% HNO ₃	10 µg/mL: Bi, Ge, In, Li6, Sc, Tb, Y	125 mL	N9303832
Internal Standard Mix			
5-10% HNO ₃	10 µg/mL: Bi, Ge, In, Li6, Sc, Tb, Y	125 mL	N9303833

Contract Required Detection Limits (CRDL)

Matrix	Contents	Vol.	Part No.
5% HNO ₃ / tr Tartaric Acid/ tr HF	120 µg/mL: Sb 100 µg/mL: Co, V 80 µg/mL: Ni 50 µg/mL: Cu 40 µg/mL: Zn 30 µg/mL: Mn 20 µg/mL: Ag, As, Cr, Tl 10 µg/mL: Be, Cd, Se 6 µg/mL: Pb	125 mL	N9300225

Performance Verification Standards

Matrix	Contents	Vol.	Part No.
Methanol Blank Solution			
1% Semiconductor Grade	10 µg/mL: Cr	125 mL	N8125037
Chromium in Methanol Solution			
1% Semiconductor Grade Methanol	10 µg/mL: Cr	125 mL	N8125038
Selenium Solution			
5% HNO ₃	10 µg/mL: Se	250 mL	N8125039
NexION® 300Q Solution Kit – Non-Cell			
Solution Kit (Includes items listed below)			N8140503
1% HNO ₃	1 x 250 mL NexION Wash Solution		N8145050
	1 X 500 mL NexION Setup Solution		N8145051
	1 X 500 mL NexION 300Q Non-cell Stability Solution		N8145053
	1 x 100 mL NexION Standard/ DRC Mode Detection Limit Blank Solution		N8145055
	1 X 100 mL NexION Standard/ DRC Mode Detection Limit Solution		N8145056
	1 x 100 mL NexION Dual Detector Solution		N8145059
NexION 300 X/D/S Solution Kit – Cell Instruments			
Solution Kit (Includes items listed below)			N8140504
1% HNO ₃	1 x 250 mL NexION Wash Solution		N8145050
	1 X 500 mL NexION Setup Solution		N8145051
	1 x 250 mL NexION KED Setup Solution		N8145052
	1 x 500 mL NexION 300X/D/S Cell Stability Solution		N8145054
	1 x 100 mL NexION Standard/DRC Mode Detection Limit Blank Solution		N8145055
	1 x 100 mL NexION Standard/DRC Mode Detection Limit Solution		N8145056

Instrument Calibration Standards (con't)

Matrix	Contents	Vol.	Part No.
	1 x 100 mL NexION KED Mode Detection Limit Blank Solution		N8145057
	1 x 100 mL NexION KED Mode Detection Limit Solution		N8145058
	1 x 100 mL NexION Dual Detector Solution		N8145059
NexION Setup Solution			
1% HNO ₃	1 µg/L: Be, Ce, Fe, In, Li, Mg, Pb, U	500 mL	N8145051
1% HNO ₃	10 µg/L: Be, Ce, Fe, In, Li, Mg, Pb, U	500 mL	N8145284
NexION KED Setup Solution			
1% HNO ₃	10 µg/mL: Be, Ce, Fe, In, Li, Mg, Pb, U	500 mL	N8145289
1% HCL	10 µg/L: Co 1 µg/L: Ce	250 mL	N8145052
NexION 300Q Non-cell Stability Solution			
1% HNO ₃	1 µg/L: Cd, Cu, Mg, Pb	500 mL	N8145053
NexION 300X/D/S Cell Stability Solution			
1% HNO ₃	1 µg/L: Cd, Cr, Fe, In, Mg, Pb 10 µg/L: Co, Cu, Se	500 mL	N8145054
NexION 300X/D Internal Standard Stock Solution			
2% HNO ₃	100 µg/mL: Sc 50 µg/mL: Ge 1 µg/mL: Rh, In, Tb	125 mL	N9308592
NexION 300Q Internal Standard Stock Solution			
2% HNO ₃	50 µg/mL: Sc, Ge 10 µg/mL: Rh, In, Tb	125 mL	N9308591
NexION Standard/DRC Mode Detection Limit Blank Solution			
0.5% HNO ₃		100 mL	N8145055
NexION Standard/DRC Mode Detection Limit Solution			
0.5% HNO ₃	1 µg/L: Be, Ca, Co, Fe, In, U	100 mL	N8145056
NexION KED Mode Detection Limit Blank Solution			
1% HCL		100 mL	N8145057
NexION KED Mode Detection Limit Solution			
1% HCL	10 µg/L: V, As, Se	100 mL	N8145058
NexION Dual Detector Solution			
2% HNO ₃	200 µg/L: Al, Ba, Ce, Co, Cu, In, Li, Mg, Mn, Ni, Pb, Tb, U, Zn	100 mL	N8145059
NexION AFT Single-Element Solution			
2% HNO ₃	2 µg/L: Fe	100 mL	N8145060
NexION AFT Multi-Element Solution			
2% HNO ₃	2 µg/L: Ag, Al, As, Ba, Be, Bi, Ce, Bi, Ca, Cd, Co, Cr, Cs, Cu, Fe, Ga, In, K, Li, Mg, Mn, Na, Ni, Pb, Rb, Se, Sr, Tl, U, V, Zn	100 mL	N8145061



Universal Data Acquisition Standards Kit

Our Universal Data Acquisition Standards Kit includes 5 standards solutions in bottles of 125 mL.

Universal Data Acquisition Standards Kit

Matrix	Contents	Vol.	Part No.
Solution Kit (Includes items listed below)			
Solution Kit (Includes items listed below)			N9306225
5% HNO ₃	10 µg/mL: Ce, Dy, Er, Eu, Gd, Ho, La, Lu, Nd, Pr, Sm, Sc, Tb, Th, Tm, Y, Yb	125 mL	N9300232
5% HNO ₃	10 µg/mL: Al, Ag, As, Ba, Be, Bi, Ca, Cd, Co, Cr, Cs, Cu, Fe, Ga, Hg*, In, K, Li, Mg, Mn, Na, Ni, Pb, Rb, Se, Sr, Tl, U, V, Zn	125 mL	N9300233
10% HCL/ 1% HNO ₃	10 µg/mL: Au, Hf, Ir, Pd, Pt, Rh, Ru, Sb, Sn, Te	125 mL	N9300234
5% HNO ₃	10 µg/mL: Hg	125 mL	N9300253
H ₂ O/tr HF /tr HNO ₃	10 µg/mL: B, Ge, Mo, Nb, P, Re, S, Si, Ta, Ti, W, Zr	125 mL	N9300235

*Supplied in separate bottle.

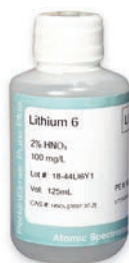

Isotope Standard

The PerkinElmer ICP and ICP-MS isotope standard comes in a 125 mL bottle and is supplied with a comprehensive Certificate of Analysis.

Isotope Standard

Matrix	Contents	Vol.	Part No.
Lithium 6 Standard			
2% HNO ₃	100 µg/mL: Li6	125 mL	N9303955



Matrix Blanks and Wash Standards

We offer wash standards and matrix blanks for your application needs.

Wash Standards

Matrix	Vol.	Part No.
ELAN DRC Wash Solution		
0.5% HNO ₃	250 mL	N8125033
ELAN 9000/6X00/DRC-e Wash Solution		
1% HNO ₃	1,000 mL	N8122038
NexION Wash Solution		
1% HNO ₃	250 mL	N8145050

Matrix Blanks

Matrix	Vol.	Part No.
Water Blank		
ASTM® Type I Water, 18 megohm	125 mL	N9303814
ASTM® Type I Water, 18 megohm	250 mL	N9303813
Hydrochloric Acid Blanks		
2% HCl in ASTM® Type I Water	125 mL	N9300238
5% HNO ₃ in ASTM® Type I Water	500 mL	N9308571
Nitric Acid Blanks		
1% HNO ₃ in ASTM® Type I Water	125 mL	N9303732
2% HNO ₃ in ASTM® Type I Water	125 mL	N0773120
5% HNO ₃ in ASTM® Type I Water	500 mL	N9308571

METALLO-ORGANIC STANDARDS



PerkinElmer Metallo-Organic Standards provide a comprehensive solution to your application needs.

Our product offering includes:

- Single and multi-element standards for the analysis of wear metals and metal additives in oil
- Reference materials for used oil analysis of fuel, soot, water, acid number, base number, or viscosity
- Sulfur standards made from polysulfide oil
- High purity matrix oils and solvents
- Proficiency testing standards with instant feedback

Each product is shipped with a comprehensive Certificate of Analysis.

Our Metallo-Organic Standards have been designed to give you the confidence you need when analyzing difficult samples.

Lubricants Guide



For more information on our Lubricants consumables offering visit www.PerkinElmer.com/lubricants. You'll find everything from application notes to a comprehensive guide of consumables for all your Lubricants analysis needs.

Single-Element, Metallo-Organic Standards

Element Name	Symbol	Matrix	Size	Part No.
Aluminum 1000 µg/g	Al	hydrocarbon oil	50 g	N9308200
Antimony 1000 µg/g	Sb	hydrocarbon oil	50 g	N9308201
Arsenic 1000 µg/g	As	hydrocarbon oil	50 g	N9308202
Barium 1000 µg/g	Ba	hydrocarbon oil	50 g	N9308203
Beryllium 1000 µg/g	Be	hydrocarbon oil	50 g	N9308204
Bismuth 1000 µg/g	Bi	hydrocarbon oil	50 g	N9308205
Boron 1000 µg/g	B	hydrocarbon oil	50 g	N9308206
Cadmium 1000 µg/g	Cd	hydrocarbon oil	50 g	N9308207
Calcium 1000 µg/g	Ca	hydrocarbon oil	50 g	N9308208
Calcium 5000 µg/g	Ca	hydrocarbon oil	50 g	N9308322
Chromium 1000 µg/g	Cr	hydrocarbon oil	50 g	N9308209
Cobalt 1000 µg/g	Co	hydrocarbon oil	50 g	N9308210
Copper 1000 µg/g	Cu	hydrocarbon oil	50 g	N9308211
Iron 1000 µg/g	Fe	hydrocarbon oil	50 g	N9308212
Lanthanum 1000 µg/g	La	hydrocarbon oil	50 g	N9308213
Lead 1000 µg/g	Pb	hydrocarbon oil	50 g	N9308214
Lithium 1000 µg/g	Li	hydrocarbon oil	50 g	N9308215
Magnesium 1000 µg/g	Mg	hydrocarbon oil	50 g	N9308216
Manganese 1000 µg/g	Mn	hydrocarbon oil	50 g	N9308217
Mercury 1000 µg/g	Hg	hydrocarbon oil	50 g	N9308218
Molybdenum 1000 µg/g	Mo	hydrocarbon oil	50 g	N9308219
Nickel 1000 µg/g	Ni	hydrocarbon oil	50 g	N9308220
Phosphorus 1000 µg/g	P	hydrocarbon oil	50 g	N9308221
Potassium 1000 µg/g	K	hydrocarbon oil	50 g	N9308222
Scandium 1000 µg/g	Sc	hydrocarbon oil	10 g	N9308255
Scandium 1000 µg/g	Sc	hydrocarbon oil	50 g	N9308223
Selenium 1000 µg/g	Se	hydrocarbon oil	50 g	N9308224
Silicon 1000 µg/g	Si	hydrocarbon oil	50 g	N9308225
Silver 1000 µg/g	Ag	hydrocarbon oil	50 g	N9308226
Sodium 1000 µg/g	Na	hydrocarbon oil	50 g	N9308227
Strontium 1000 µg/g	Sr	hydrocarbon oil	50 g	N9308228
Sulfur 10 µg/g	S	hydrocarbon oil	50 g	N9308229
Sulfur 100 µg/g	S	hydrocarbon oil	50 g	N9308230
Sulfur 1000 µg/g	S	hydrocarbon oil	50 g	N9308231
Thallium 1000 µg/g	Tl	hydrocarbon oil	50 g	N9308232
Tin 1000 µg/g	Sn	hydrocarbon oil	50 g	N9308233
Titanium 1000 µg/g	Ti	hydrocarbon oil	50 g	N9308234
Vanadium 1000 µg/g	V	hydrocarbon oil	50 g	N9308235
Yttrium 1000 µg/g	Y	hydrocarbon oil	50 g	N9308236
Yttrium 5000 µg/g	Y	hydrocarbon oil	50 g	N9308323
Zinc 1000 µg/g	Zn	hydrocarbon oil	50 g	N9308237
Zirconium 1000 µg/g	Zr	hydrocarbon oil	50 g	N9308238

V-21 Wear Metal Standards

Includes: Ag, Al, B, Ba, Ca, Cd, Cr, Cu, Fe, Mg, Mn, Mo, Na, Ni, P, Pb, Si, Sn, Ti, V, Zn

Description	Matrix	Size	Part No.
V-21 Wear Metals Standard 10 µg/g	hydrocarbon oil	100 g	N9308300
V-21 Wear Metals Standard 10 µg/g	hydrocarbon oil	200 g	N9308301
V-21 Wear Metals Standard 10 µg/g	hydrocarbon oil	400 g	N9308324
V-21 Wear Metals Standard 30 µg/g	hydrocarbon oil	100 g	N9308302
V-21 Wear Metals Standard 30 µg/g	hydrocarbon oil	200 g	N9308303
V-21 Wear Metals Standard 30 µg/g	hydrocarbon oil	400 g	N9308325
V-21 Wear Metals Standard 50 µg/g	hydrocarbon oil	100 g	N9308304
V-21 Wear Metals Standard 50 µg/g	hydrocarbon oil	200 g	N9308305
V-21 Wear Metals Standard 50 µg/g	hydrocarbon oil	400 g	N9308326
V-21 Wear Metals Standard 100 µg/g	hydrocarbon oil	100 g	N9308306
V-21 Wear Metals Standard 100 µg/g	hydrocarbon oil	200 g	N9308307
V-21 Wear Metals Standard 100 µg/g	hydrocarbon oil	400 g	N9308327
V-21 Wear Metals Standard 300 µg/g	hydrocarbon oil	100 g	N9308308
V-21 Wear Metals Standard 300 µg/g	hydrocarbon oil	200 g	N9308309
V-21 Wear Metals Standard 300 µg/g	hydrocarbon oil	400 g	N9308328
V-21 Wear Metals Standard 500 µg/g	hydrocarbon oil	100 g	N9308310
V-21 Wear Metals Standard 500 µg/g	hydrocarbon oil	200 g	N9308311
V-21 Wear Metals Standard 500 µg/g	hydrocarbon oil	400 g	N9308329
V-21 Wear Metals Standard 900 µg/g	hydrocarbon oil	100 g	N9308312
V-21 Wear Metals Standard 900 µg/g	hydrocarbon oil	200 g	N9308313
V-21 Wear Metals Standard 900 µg/g	hydrocarbon oil	400 g	N9308330

V-21+K Wear Metal Standards

Includes: Ag, Al, B, Ba, Ca, Cd, Cr, Cu, Fe, K, Mg, Mn, Mo, Na, Ni, P, Pb, Si, Sn, Ti, V, Zn

Description	Matrix	Size	Part No.
V-21+K Wear Metals Standard 10 µg/g	hydrocarbon oil	100 g	N9308355
V-21+K Wear Metals Standard 10 µg/g	hydrocarbon oil	200 g	N9308356
V-21+K Wear Metals Standard 30 µg/g	hydrocarbon oil	100 g	N9308357
V-21+K Wear Metals Standard 30 µg/g	hydrocarbon oil	200 g	N9308358
V-21+K Wear Metals Standard 30 µg/g	hydrocarbon oil	400 g	N9308371
V-21+K Wear Metals Standard 50 µg/g	hydrocarbon oil	100 g	N9308359
V-21+K Wear Metals Standard 50 µg/g	hydrocarbon oil	200 g	N9308360
V-21+K Wear Metals Standard 50 µg/g	hydrocarbon oil	400 g	N9308372
V-21+K Wear Metals Standard 100 µg/g	hydrocarbon oil	100 g	N9308361
V-21+K Wear Metals Standard 100 µg/g	hydrocarbon oil	200 g	N9308362
V-21+K Wear Metals Standard 100 µg/g	hydrocarbon oil	400 g	N9308373
V-21+K Wear Metals Standard 300 µg/g	hydrocarbon oil	100 g	N9308363
V-21+K Wear Metals Standard 300 µg/g	hydrocarbon oil	200 g	N9308364
V-21+K Wear Metals Standard 500 µg/g	hydrocarbon oil	100 g	N9308365
V-21+K Wear Metals Standard 500 µg/g	hydrocarbon oil	200 g	N9308366
V-21+K Wear Metals Standard 500 µg/g	hydrocarbon oil	400 g	N9308374
V-21+K Wear Metals Standard 900 µg/g	hydrocarbon oil	100 g	N9308367
V-21+K Wear Metals Standard 900 µg/g	hydrocarbon oil	200 g	N9308368

V-23 Wear Metal Standards

Includes: Ag, Al, B, Ba, Ca, Cd, Cr, Cu, Fe, K, Mg, Mn, Mo, Na, Ni, P, Pb, Sb, Si, Sn, Ti, V, Zn

Description	Matrix	Size	Part No.
V-23 Wear Metals Standard 10 µg/g	hydrocarbon oil	100 g	N9308239
V-23 Wear Metals Standard 10 µg/g	hydrocarbon oil	200 g	N0776109
V-23 Wear Metals Standard 10 µg/g	hydrocarbon oil	400 g	N9308315
V-23 Wear Metals Standard 30 µg/g	hydrocarbon oil	100 g	N9308241
V-23 Wear Metals Standard 30 µg/g	hydrocarbon oil	200 g	N9308242
V-23 Wear Metals Standard 30 µg/g	hydrocarbon oil	400 g	N9308316
V-23 Wear Metals Standard 50 µg/g	hydrocarbon oil	100 g	N9308243
V-23 Wear Metals Standard 50 µg/g	hydrocarbon oil	200 g	N0776104
V-23 Wear Metals Standard 50 µg/g	hydrocarbon oil	400 g	N9308317
V-23 Wear Metals Standard 100 µg/g	hydrocarbon oil	100 g	N9308245
V-23 Wear Metals Standard 100 µg/g	hydrocarbon oil	200 g	N0776105
V-23 Wear Metals Standard 100 µg/g	hydrocarbon oil	400 g	N9308318
V-23 Wear Metals Standard 300 µg/g	hydrocarbon oil	100 g	N9308247
V-23 Wear Metals Standard 300 µg/g	hydrocarbon oil	200 g	N9308248
V-23 Wear Metals Standard 300 µg/g	hydrocarbon oil	400 g	N9308319
V-23 Wear Metals Standard 500 µg/g	hydrocarbon oil	100 g	N9308249
V-23 Wear Metals Standard 500 µg/g	hydrocarbon oil	200 g	N0776106
V-23 Wear Metals Standard 500 µg/g	hydrocarbon oil	400 g	N9308320
V-23 Wear Metals Standard 900 µg/g	hydrocarbon oil	100 g	N9308251
V-23 Wear Metals Standard 900 µg/g	hydrocarbon oil	200 g	N9308252
V-23 Wear Metals Standard 900 µg/g	hydrocarbon oil	400 g	N9308321

Internal Standards

Description	Matrix	Size	Part No.
Cobalt (Co) Internal Standard, 6%	mineral spirits	200 g	N0776107
Cobalt (Co) Internal Standard, 6%	mineral spirits	400 g	N9308334
Cobalt (Co) Internal Standard, 5000 µg/g	hydrocarbon oil	50 g	N9308258
Cobalt Sulfur-Free Metallo-Organic Concentrate: Co @ approx 3%	hydrocarbon oil	400 g	N9304168



Metal Additive Standards

Description	Matrix	Size	Part No.
Metal Additive Standard 3: Ca @ 5000 µg/g; P, Zn @ 1600 µg/g	hydrocarbon oil	100 g	N9308369
Metal Additive Standard 3: Ca @ 5000 µg/g; P, Zn @ 1600 µg/g	hydrocarbon oil	200 g	N9308370
Metal Additive Standard 3: Ca @ 5000 µg/g; P, Zn @ 1600 µg/g	hydrocarbon oil	400 g	N9308552
Metal Additive Standard 4: Ca @ 5000 µg/g; Mg, P, Zn @ 1600 µg/g	hydrocarbon oil	100 g	N9308259
Metal Additive Standard 4: Ca @ 5000 µg/g; Mg, P, Zn @ 1600 µg/g	hydrocarbon oil	200 g	N0776108
Metal Additive Standard 4: Ca @ 5000 µg/g; Mg, P, Zn @ 1600 µg/g	hydrocarbon oil	400 g	N9308333



V-Solv™ ICP Solvent 1 Gallon



V-Solv™ ICP Solvent 5 Gallon

V-Solv™ ICP Solvent is a proprietary solvent that is used for diluting oil and other organic liquids for analysis by ICP and ICP-MS. Use V-Solv™ as a matrix blank and as a diluent for your calibration standards and samples for outstanding nebulization characteristics.

Citrajel cleaner is ideal for use in labware washers, manual and ultrasonic cleaning. Use on glassware, metals, plastics, ceramics, porcelain, rubber and fiberglass. Corrosion inhibiting formula removes metal oxides, scale, salts, inorganic residues, trace metals and amphoteric proteins. Suitable for acid washing and rinsing.

Matrix Oils and Solvents

Description	Matrix	Size	Part No.
Hydrocarbon Oil	75 cSt oil	500 mL	N0776103
Hydrocarbon Oil	75 cSt oil	1 Gal.	N9308262
Mineral Oil (low sulfur)	20 cSt mineral oil	500 mL	N9308263
Mineral Oil (low sulfur)	20 cSt mineral oil	1/2 Gal.	N9308264
V-Solv™ ICP Solvent	hydrocarbon oil	1 Gal.	N9308265
V-Solv™ ICP Solvent	hydrocarbon oil	5 Gal.	N9308378
Citrajel® Liquid Acid Cleaner		1 Gal.	N0777063
Citrajel® Liquid Acid Cleaner		5 Gal.	N0777064

Fuel Dilution Standards

Description	Matrix	Size	Part No.
Blank for Diesel Fuel Dilution Standard	75 cSt hydrocarbon oil	100 mL	N9308266
2% (v/v) Devolatilized Diesel Fuel in Hydrocarbon Oil	75 cSt hydrocarbon oil	100 mL	N9308267
4% (v/v) Devolatilized Diesel Fuel in Hydrocarbon Oil	75 cSt hydrocarbon oil	100 mL	N9308297
5% (v/v) Devolatilized Diesel Fuel in Hydrocarbon Oil	75 cSt hydrocarbon oil	100 mL	N9308268
10% (v/v) Devolatilized Diesel Fuel in Hydrocarbon Oil	75 cSt hydrocarbon oil	100 mL	N9308269
Blank for Gas Fuel Dilution Standard	75 cSt hydrocarbon oil	100 mL	N9308270
2% (v/v) Devolatilized Gasoline in Hydrocarbon Oil	75 cSt hydrocarbon oil	100 mL	N9308271
5% (v/v) Devolatilized Gasoline in Hydrocarbon Oil	75 cSt hydrocarbon oil	100 mL	N9308272
10% (v/v) Devolatilized Gasoline in Hydrocarbon Oil	75 cSt hydrocarbon oil	100 mL	N9308273
Blank	20 cSt hydrocarbon oil	100 mL	N9308274

Acid Number Standards

Description	Matrix	Size	Part No.
Acid Number (AN) Reference Material, 0.1 mg KOH/g	hydrocarbon Oil	100 g	N9308160
Acid Number (AN) Reference Material, 0.1 mg KOH/g	hydrocarbon Oil	400 g	N9308161
Acid Number (AN) Reference Material, 1 mg KOH/g	hydrocarbon Oil	100 g	N9308162
Acid Number (AN) Reference Material, 1 mg KOH/g	hydrocarbon Oil	400 g	N9308163
Acid Number (AN) Reference Material, 1.5 mg KOH/g	hydrocarbon Oil	100 g	N9308164
Acid Number (AN) Reference Material, 1.5 mg KOH/g	hydrocarbon Oil	400 g	N9308165
Acid Number (AN) Reference Material, 0.5 mg KOH/g	hydrocarbon Oil	100 g	N9308166
Acid Number (AN) Reference Material, 0.5 mg KOH/g	hydrocarbon Oil	400 g	N9308167
Acid Number (AN) Reference Material, 3 mg KOH/g	hydrocarbon Oil	50 g	N9308168
Acid Number (AN) Reference Material, 3 mg KOH/g	hydrocarbon Oil	400 g	N9308169
Acid Number (AN) Reference Material, 2 mg KOH/g	hydrocarbon Oil	50 g	N9308170

Base Number Standards

Description	Matrix	Size	Part No.
Base Number (BN) Reference Material, 10 mg KOH/g	hydrocarbon Oil	50 g	N9308555
Base Number (BN) Reference Material, 10 mg KOH/g	hydrocarbon Oil	400 g	N9308173
Base Number (BN) Reference Material, 15 mg KOH/g	hydrocarbon Oil	50 g	N9308174
Base Number (BN) Reference Material, 30 mg KOH/g	hydrocarbon Oil	50 g	N9308176
Base Number (BN) Reference Material, 30 mg KOH/g	hydrocarbon Oil	400 g	N9308177
Base Number (BN) Reference Material, 40 mg KOH/g	hydrocarbon Oil	50 g	N9308178
Base Number (BN) Reference Material, 6 mg KOH/g	hydrocarbon Oil	50 g	N9308554
Base Number (BN) Reference Material, 6 mg KOH/g	hydrocarbon Oil	400 g	N9308181
Base Number (BN) Reference Material, 70 mg KOH/g	hydrocarbon Oil	50 g	N9308182



Karl Fischer Standards

Nominal Water Concentration (%)	Matrix	Size	Part No.
Karl Fischer Water in Oil, Blank	10W30 motor oil	50 g	N9308278
Karl Fischer Water in Oil, 0.1%	10W30 motor oil	400 g	N9308279
Karl Fischer Water in Oil, 0.5%	10W30 motor oil	50 g	N9308280
Karl Fischer Water in Oil, 1.0%	10W30 motor oil	50 g	N9308281

Soot Content Standards

Nominal Water Concentration (%)	Matrix	Size	Part No.
Nominal Soot Content Range: Blank	15W40 diesel oil	50 mL	N9308282
Nominal Soot Content Range: 0.5-2%	15W40 diesel oil	50 mL	N9308283
Nominal Soot Content Range: 2-4%	15W40 diesel oil	50 mL	N9308284
Nominal Soot Content Range: 4-6%	15W40 diesel oil	50 mL	N9308285

Biodiesel Standards

Description	Matrix	Size	Part No.
Biodiesel Blank	B100 biodiesel	100 mL	N9308286
Biodiesel Blank	B100 biodiesel	500 mL	N9308287
Sulfur @ 20 µg/g in Biodiesel	B100 biodiesel	100 mL	N9308288
Metals in Biodiesel – Ca, K, Mg, Na, P @ 20 µg/g	B100 biodiesel	100 g	N9308289
Metals in Biodiesel - Ca, K, Mg, Na, P @ 5µg/g	B100 Biodiesel	100 g	N9308726

Coolant Standards

Description	Matrix	Size	Part No.
Custom HI 1A: Al @ 10µg/mL; Mg @ 20µg/mL; Ca @ 32µg/mL; Cu, Fe, Pb, Zn @ 50µg/mL; B @ 1000µg/mL; P @ 2000µg/mL; K @ 5000µg/mL; Na @ 10,000µg/mL 3% HNO3 (v/v)		500mL	N9308341
Custom QC 1A: Al, Cu @ 5µg/mL; Mg @ 10µg/mL; Zn @ 20µg/mL; Fe, Pb @ 25µg/mL; Ca @ 50µg/mL; B @ 250µg/mL; P @ 1000µg/mL; K @ 2500µg/mL; Na @ 5000µg/mL 3% HNO3 (v/v)		500mL	N9308342
Custom LO 1A: Al, Cu @ 2µg/mL; Mg, Zn @ 4µg/mL; Fe @ 5µg/mL; Ca, Pb @ 10µg/mL; B @ 50µg/mL; P @ 400µg/mL; K, Na @ 1000µg/mL 3% HNO3 (v/v)		500mL	N9308343
Custom QC 1B: Sn @ 10µg/mL; Si @ 30µg/mL; Mo @ 50µg/mL 3% HNO3 (v/v)/tr HF 500mL		500mL	N9308344
Custom LO 1B: Sn @ 5µg/mL; Si @ 10µg/mL; Mo @ 20µg/mL 3% HNO3 (v/v)/tr HF		500mL	N9308345
Custom HI 1B: Sn @ 20µg/mL; Mo, Si @ 100µg/mL 3% HNO3 (v/v)/tr HF		500mL	N9308346

Sulfur Standards

Description	Matrix	Size	Part No.
Polysulfide Oil Blank	13 cSt Mineral Oil	500 mL	N9308390
Sulfur @ 500 µg/g, from Polysulfide Oil	13 cSt Mineral Oil	500 mL	N9308391
Sulfur @ 1000 µg/g, from Polysulfide Oil	13 cSt Mineral Oil	500 mL	N9308392
Sulfur @ 5000 µg/g, from Polysulfide Oil	13 cSt Mineral Oil	500 mL	N9308393
Sulfur @ 1 wt%, from Polysulfide Oil	13 cSt Mineral Oil	500 mL	N9308394
Sulfur @ 5 wt%, from Polysulfide Oil	13 cSt Mineral Oil	500 mL	N9308395
Sulfur @ 0 µg/g (Blank)	#2 Diesel Fuel	500 mL	N9308714
Sulfur @ 5 µg/g, from Polysulfide Oil	#2 Diesel Fuel	500 mL	N9308715
Sulfur @ 10 µg/g, from Polysulfide Oil	#2 Diesel Fuel	500 mL	N9308716
Sulfur @ 15 µg/g, from Polysulfide Oil	#2 Diesel Fuel	500 mL	N9308717
Sulfur @ 20 µg/g, from Polysulfide Oil	#2 Diesel Fuel	500 mL	N9308718
Sulfur @ 25 µg/g, from Polysulfide Oil	#2 Diesel Fuel	500 mL	N9308719
Sulfur @ 50 µg/g, from Polysulfide Oil	#2 Diesel Fuel	500 mL	N9308720
Sulfur @ 100 µg/g, from Polysulfide Oil	#2 Diesel Fuel	500 mL	N9308721
Sulfur @ 500 µg/g, from Polysulfide Oil	#2 Diesel Fuel	500 mL	N9308722
Sulfur @ 1000 µg/g, from Polysulfide Oil	#2 Diesel Fuel	500 mL	N9308723
Sulfur @ 1500 µg/g, from Polysulfide Oil	#2 Diesel Fuel	500 mL	N9308724



OilExpress Standards

Description	Matrix	Size	Part No.
In-Service Lubricants FT-IR Control Standard	15W40 Diesel Oil	100 g	N9308350
In-Service Lubricants FT-IR Control Standard	15W40 Diesel Oil	500 g	N9308375
OilExpress 4 Test Oil 120 cSt	PAO Oils	500 g	N9308351
OilExpress 4 Test Oil 360 cSt	PAO Oils	100 g	N9308352
OilExpress 4 System Liquid Detergent Additive		100 g	N9308354
OilExpress 4 System Liquid Detergent Additive		500 mL	N9308376
OilExpress 4 System Liquid Detergent Additive		1 Gal.	N9308380
Pathlength Calibration Fluid (Squalane)		50 mL	N9308377
OilExpress 4 Installation Kit (includes N9308350, N9308351, N9308352, N9308354, and N9308377)		Kit	N9300850

Biodiesel Blends for IR

Description	Matrix	Size	Part No.
100% High Cetane Diesel	High Cetane Diesel Fuel	20 mL	N9308290
2% (v/v) Biodiesel	High Cetane Diesel Fuel	20 mL	N9308291
5% (v/v) Biodiesel	High Cetane Diesel Fuel	20 mL	N9308292
10% (v/v) Biodiesel	High Cetane Diesel Fuel	20 mL	N9308293
15% (v/v) Biodiesel	High Cetane Diesel Fuel	20 mL	N9308294
20% (v/v) Biodiesel	High Cetane Diesel Fuel	20 mL	N9308295
100% (v/v) Biodiesel	B100 biodiesel	20 mL	N9308296

Viscosity Reference Standards



Viscosity Reference Standards

Description	Matrix	Size	Part No.
Viscosity Standard Reference Kit	Hydrocarbons	5 x 500 mL	N5316000
Nominal Viscosity: 4.5 cSt at 40 °C, and 1.6 cSt at 100 °C	Hydrocarbons	500 mL	N9307740
Nominal Viscosity: 10 cSt at 40 °C, and 2.7 cSt at 100 °C	Hydrocarbons	500 mL	N5316001
Nominal Viscosity: 30 cSt at 40 °C, and 5.3 cSt at 100 °C	Hydrocarbons	500 mL	N5316002
Nominal Viscosity: 30 cSt at 40 °C, and 5.3 cSt at 100 °C	Hydrocarbons	1 Gal.	N5316025
Nominal Viscosity: 100 cSt at 40 °C, and 16.8 cSt at 100 °C	Hydrocarbons	500 mL	N5316003
Nominal Viscosity: 100 cSt at 40 °C, and 16.8 cSt at 100 °C	Hydrocarbons	1 Gal.	N5316024
Nominal Viscosity: 360 cSt at 40 °C, and 42 cSt at 100 °C	Hydrocarbons	500 mL	N5316004
Nominal Viscosity: 930 cSt at 40 °C, and 82 cSt at 100 °C	Hydrocarbons	500 mL	N5316005

Proficiency Testing Standards



Proficiency Testing Standards

Proficiency Testing Program

The Proficiency Testing Program offered by PerkinElmer has been designed to provide laboratories with a method of monitoring their analytical performance as measured against Certified Reference Materials (CRMs).

1. Analyze a sample
2. Report the results online
3. Receive an instant response to submitted values

Confirm the accuracy of your analytical results, quickly, easily, and definitively.

Description	Size	Part No.
PTP Standard for Elemental Analysis of Oils	25 g	N9308314

Note: Analyze a sample for up to 23 common elements and report the concentrations in µg/g (ppm). Enter all elements or only those that are of interest to you. Results are color-coded pass/fail indications in green (pass), yellow (borderline), and red (fail).

Description	Size	Part No.
Sample for Particle Count Analysis	125 mL	N9308725

Note: Particle Count PTP test standard includes 8 channels (4, 6, 8, 14, 21, 38, 50 and 70 µm). One bottle for ISO 11171 only.

Description	Size	Part No.
Viscosity PTP Test Standard	50 mL	N9308540

Note: Report viscosity values in cSt at 40 °C, 100 °C, or both.

PolyScience® WhisperCool™ Refrigerated Chiller

The PolyScience® WhisperCool® Refrigerated Chiller is designed to deliver quiet and reliable performance over a broad range of operating temperatures and conditions. Extremely dependable and energy efficient, it features a -10 to 40 °C operating temperature range, built-in process and equipment protection, and highly intuitive user interface. This chiller is designed for use on both ICP-OES and ICP-MS instruments.

Key Advantages

- 50% quieter operation than comparable models (62 dB*)
 - 2900 watts (9889 BTU/hour) cooling capacity
 - Built-in temperature, pressure, and flow rate alarms
- * WhisperCool® environmental control reduces operational noise (62 dB)

ICP Chiller Coolant Mix
Part No: N0776099



Ordering Information

Part No.	N0772046	N0772045	
Electrical Requirements	208-230 V, 60 Hz, 12.2 A	240 V, 50 Hz, 12.2 A	
Operating Temperature Range	-10 to 40 °C	-10 to 40 °C	
Temperature Stability	±0.1 °C (±1.8 °F)	±0.1 °C (±1.8 °F)	
Cooling Capacity	at 20 °C at 10 °C at 0 °C	2900 Watts (9889 BTU/hr) 1925 Watts (6574 BTU/hr) 1000 Watts (3410 BTU/hr)	2650 Watts (9889 BTU/hr) 1900 Watts (6574 BTU/hr) 1200 Watts (3410 BTU/hr)
Compressor	1.0 HP	1.0 HP	
Reservoir Capacity	4.2 L	4.2 L	
Pump Type	Turbine	Turbine	
Maximum Pump Pressure	90 PSI	83 PSI	
Maximum Pump Flow	13.2 LPM	13.2 LPM	
Dimensions	22 5/8 x 14 1/2 x 27 5/8 in / 57.6 x 36.8 x 70.2 cm		
Shipping Weight	189 lb / 85.7 kg		
Replacement Air Filter	N0777095 (Air Filter with Frame, 13 x 14 in)		
ICP Chiller Coolant Mix	N0776099 (Five Half-gallon bottles)		
ICPMS Chiller Coolant Mix	WE016558 (1 liter bottles) for ELAN/NexION		
Stainless Steel Strainer for Reservoir	N0691907		

At-a-glance access to pressure and flow rate information

Adaptive environmental technology optimizes compressor and evaporator performance to reduce overall energy consumption

Smart electronics control fan speed based on cooling demand, reducing operating noise by as much as 50%

Louvered side and rear vents for added noise dampening

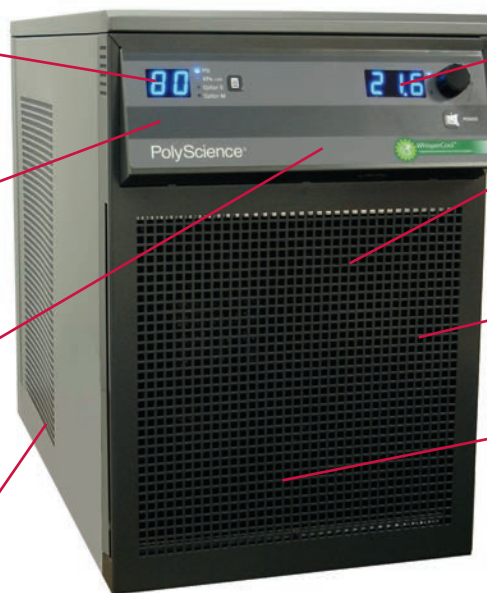

±0.1 °C temperature stability

High performance turbine pump with vibration isolators for quiet fluid flow

Compact portable design

Washable air filter removes quickly for easy cleaning



Heat Exchanger System

Cooling systems for the ELAN 9000/DRC II/e/NexION systems. Air cooled recirculator without refrigeration. Not to be placed in areas with temperatures above 30 °C (86 °F). Requires the use of Coolant Fluid (WE016558).

ICP-MS Power Requirement	Part No.
120 V, 60 Hz	N8122248
220/250 V, 50/60 Hz	N8122247

NOISE ENCLOSURES



For NexION® Leybold SV40 Vacuum Pump

External Dimensions	Centimeters	Inches
Depth	67.4	26.5
Width	45.6	17.95
Height	55	21.65
Height with oil tray	64.6	25.39
Weight	Kilograms	Pounds (lbs)
Enclosure	14	30.8
Oil tray	8	16.75

Description	Part No.
Noise enclosure (dolly not included)	N8121068
Noise enclosure with Built-in Overheating Temperature Alarm (dolly not included)	N8145407
Noise enclosure dolly (option)	N8121069
Noise reduction cover (dolly not included)	MZ321146
Noise reduction cover dolly (option)	MZ321147



Vacuum Pump
Noise Enclosure



Vacuum Pump
Noise Reduction Cover

Noise Enclosures for Vacuum Pumps and Chillers

Laboratories can be loud and noise in labs is distracting, stressful and potentially harmful to your hearing. While noise in labs may not be frequently talked about, it is something you should be concerned with.

Our noise reduction enclosures are designed specifically for your instrument. They provide noise reduction performance from -12 db(A) up to -20 db(A), equivalent to a 75% reduction in noise perception! Thick 50 mm Polyurethane acoustic open cell foam covers the interior part of the enclosure, delivering good noise absorption. The wave shape of the foam multiplies the absorption capacity, providing you with a quieter, safer lab. Each noise enclosure has efficient air circulation, is easy-to-install and maintain and is compatible with all electrical outlets worldwide.

Chiller Noise Enclosure Key Advantages

- Performance: average sound level decrease is - 15 dB(A) (equivalent to a 75% reduction in noise perception).
- Environment friendly noise adsorbing material, oil and water resistant.
- Heat exchange controlled by six internal silent fans.
- Worldwide electrical compatibility-enclosures are delivered with European, US, Japan, and UK plugs.
- Easy access to front monitor and switch (the transparent window can be opened).
- Easy water level check (window on the back panel).
- Includes Overheating temperature alarm.
- The noise reduction is in conformity with the European directive related to low voltage equipment(2006/95/EC) and electromagnetic compatibility (2004/108/EC).
- Power supply Csa, Ce and Ccc

For Model: Polyscience 6000 Series

External Dimensions	Centimeters	Inches
Depth	88	34.7
Width	57	23.7
Height	71	30.7

Description	Part No.
Chiller Enclosure	N077920



POWER CONDITIONERS AND UPS SYSTEMS

Damaged or compromised components, disrupted processes, lack of reliability – they all add up to frustration, broken schedules and costly downtime. The problem is caused by a host of power disturbances – some visible and many invisible – that threaten

your equipment’s operation every year. Power “disturbances” are simply those large and small variations in the quality of the electric power you use day in and day out. Some come from your local utility company, but most are created within your own facility as a result of the distribution and use of electrical power. These variations include high-energy voltage transients, sags and swells, electrical noise, and common mode voltage, as well as the power outages everyone witnesses when the lights go out.

Power Conditioners

Instrument Model	Description	Frequency (Hz)	Part No.
ATOMIC ABSORPTION			
AAAnalyst™ 100/200/300/400	520 VA	60	N9307504
AAAnalyst 100/200/300/400/PinAAcle™ 900 F	750 VA	50	N9307521
AAAnalyst 600/800	5.8 kVA	60	N9307511
AAAnalyst 600/800	6.0 kVA	50	N9307523
AAAnalyst 700	3.8 kVA	60	N9307509
AAAnalyst 700	3.6 kVA	50	N9307522
PinAAcle 900 H/T/Z	5.8 kVA	60	N9307760
PinAAcle 900 H/T/Z	6.0 kVA	50	N9307523
PinAAcle 900F	720 VA	60	N9307515
ICP-OES			
Optima™ 2x00/4x00/5x00/7x00/8x00	3.8 kVA	60	N9307512
Optima 2x00/4x00/5x00/7x00/8x00	3.6 kVA	50	N9307522
ICP-MS			
ELAN® 6x00/9000 Controller Side	3.8 kVA	60	N9307519
ELAN 6x00/9000 Controller Side	3.6 kVA	50	N9307522
AAAnalyst 600/800/ELAN 6x00/9000 RF Generator Side	5.8 kVA	60	N9307511
ELAN 6x00/9000/NexION® RF Generator Side	6.0 kVA	50	N9307523
NexION	5.0 kVA	60	N0777690
TITAN MPSTM			
Titan MPS	2.0 kVA	60	N9306758
Titan MPS	2.0 kVA	50	N9306755



On-Line Conditioned Uninterruptible Power Supply Systems

With the Security Plus Series, you get much more protection and a higher comfort level than you get with most other UPS systems. The Security Plus Series also provides complete power conditioning and, because the Security Plus Series features on-line inverter design, added peace of mind. And regardless of input fluctuations, the Security Plus Series insures that the output remains continuous and regulated.

UPS Systems

Instrument Model	Description	Frequency (Hz)	Part No.
ATOMIC ABSORPTION			
PinAAcle 900F/AAAnalyst 100/200/300/400	800 VA	60	N0777681
PinAAcle 900F/AAAnalyst 100/200/300/400	800 VA	50	N0777689
AAAnalyst 700/HGA 900	5.2 kVA	50/60	N9308150
PinAAcle 900 T/H/Z	10 kVA	50/60	N9306757
AAAnalyst 600/800	10 kVA	50/60	N0777613
ICP-OES			
Optima 2x00/4x00/5x00/7x00/8x00	5.2 kVA	50/60	N0777511
ICP-MS			
NexION	8.0 kVA	50/60	N0777682
ELAN	12 kVA	50/60	N0777719



TESTED AND APPROVED

Acetylene Regulator

For AA labs, this regulator includes an adapter so that the pressure regulator can be connected to cylinders requiring either CGA 300 or CGA 510 fittings and a connector for attaching the fuel hose assembly supplied with the instrument. Includes hose assembly.



Description	Part No.
Max Inlet Pressure: 400 psig	03030106

Air Regulator

For AA labs. Regulator to cylinder CGA no. 590. Includes hose assembly.



Description	Part No.
Max Inlet Pressure: 3,000 psig	03030264

Nitrous Oxide Regulator

For use in AA labs with gas cylinders with a CGA 326 connection. Provides pressure control from 350–520 kPa (50–75 psig) and contains an integral thermostatted heater to prevent freezing of the regulator diaphragm.



Description	Part No.
115 V	03030204
220 V	03030349

Argon/Nitrogen Regulator

For AA and ICP, this regulator can be used with argon or nitrogen and has a CGA 580 fitting. A color-coded hose with ¼" SWAGELOK® fittings is also included.



Description	Part No.
Max Inlet Pressure: 3,000 psig	03030284

Matheson Flashback Arrestor

Because acetylene is an extremely unstable gas, users can experience flashbacks at the instrument burner head. The flash arrestor prevents these potentially dangerous flashbacks from reaching the regulator or cylinder.



Description	Part No.
Acetylene Max Operating Pressure: 15 psig	N9300068

Hose Assemblies

Hose assemblies for connecting fuel, air and nitrous oxide from supply to instrument.



Description	Part No.
Acetylene, Red Neoprene, 3.7 m (12 ft)	00570559
Air/Argon, Black, 3.7 m (12 ft)	00570567
Nitrous Oxide, Blue, 3.7 m (12 ft)	00470258

Blower and Vent Assembly for AA and ICP

A venting system is required to remove fumes and vapors from the torch of ICP emission spectrometers. A vent is recommended for use over the power supply unit of most ICP spectrometers for removal of dissipated heat. Use exhaust venting to:

- Protect lab personnel from toxic vapors
- Protect your instrument from corrosive vapors
- Improve stability of the ICP torch



Includes Exhaust Hood, Adapter and Blower. Does not include ducting. PerkinElmer service engineers are not permitted to install this unit.

Description	Part No.
110 V	03030447
230 V	03030448

Parker Balston® 73-099 AA Gas Purifier

For AA labs, this wall-mounted system designed to purify the compressed air and acetylene gases used in atomic absorption. It consists of two independent filtration systems, one for compressed air and one for acetylene. The unit also has a flashback arrestor on the acetylene line and a pressure regulator on the compressed air line.



The 2-stage air filtration assembly consists of a Balston Grade DX coalescing filter and a Balston Grade BX coalescing filter. Together these filters remove oil, water and particulate contamination (99.99% at 0.01 micron) from the compressed air supply.

Description	Part No.
Parker Balston 73-099 AA Gas Purifier	N9301398

Parker Balston® Replacement Filters

Description	Cartridges Part No.	Seal Sets Part Part No.
1st Air Filter	N9301710	N9301712
2nd Air Filter	N9301711	N9301712
Acetylene Filter	N9301714	N9301715

Balston® 95A Acetylene Filter

For your AA lab, this filter includes a Balston Grade BQ filter cartridge to remove liquid and solid contaminants from the acetylene supply to 99.99% at 0.01 micron. Max working pressure: 15 psig.



Description	Part No.
Acetylene Filter	N9301399
Replacement Acetylene Filter Cartridge	N9301714

Balston® Air Filter Assembly Type A-82

For AA and ICP labs, this filter is specifically designed to remove water, oil and dirt particles down to 0.6 microns in diameter from compressed air lines. It is recommended for use with oil-type compressors and for removing moisture and dirt particles from air supplied by oil-less compressors. Also recommended to filter argon for the PinAAcle furnace.



Description	Part No.
Air Filter Assembly	N0580531
Replacement Filter Cartridge Element	N0582251

Air Dryer Filter Assembly with R250 Regulator

To filter compressed air for AA and ICP instrumentation. Replaces 00470652 and N0770198.



Description	Part No.
Air Dryer Filter Assembly with R250 Regulator	N0775325
Replacement Filter Element	N9306067
Float Assembly	N0777710
Bowl O-Ring	N0777328

Wilkerson® Air Dryer Filter Accessories*

Description	Pre-Filter Part Part No.	Final Filter Part No.
Filter Elements	09923464	09907120
Filter Bowls	N9302199	N9302199
Bowl O-Ring Kit, Final Filter	N9302197	N9301715

* For Wilkerson Filter PerkinElmer (00470652)

ICP Filter Replacement Parts

ICP Model	Filter Element	Part No.
2x00/3x00/4x00/5x00/7x00/8x00	Air filter in front of spectrometer fan	09995098
2x00/3x00/4x00	Water Filter	09904845
2x00/3x00/4x00	Cartridge for Water Filter	09904846
2x00/4x00/5x00/7x00/8x00	Air Filter for the RF Generator Inlet	N0775220
3x00	Washable Air Filter for the RF Generator Inlet	02509115
3x00	Disposable Air Filter for the RF Generator Inlet	09923517

Instrument Filters

Description	Part No.
For AAAnalyst 100/300/PinAAcle 900	09995097
For AAAnalyst 200/400/600/700/800	B0501696
For AAAnalyst 600/700/800 (80x80)	B0502706
For Optima 2x00/3x00/4x00/5x00/7x00/8x00	09995098
For NexION (left)	W1036712
For NexION (back right)	W1036713

Polyscience Replacement Air Filters

Description	Part No.
Polyscience Air Filter	N0777359
Polyscience Air Filter with Frame	N0777095
Heat Exchanger Air Filter	N0777360

SAMPLE PREPARATION BLOCK SYSTEMS



PerkinElmer offers a variety of sample preparation blocks and accessories for your lab needs.

Better laboratory practices demand modern techniques in sample preparation. In the past, hot plates were used to digest samples where common digestion problems involved rusting, cross contamination of digestion system to sample, and poor sample temperature control.

With no exposed metal components and an outer shell manufactured from acid-resistant thermoplastic, the SPB blocks reduce the chances of sample contamination. Each system is constructed with a solid, PTFE-coated, graphite block where a flat heater covers 95% of the block's base. This guarantees temperature uniformity and eliminates hot spots found in hot plates.

All PerkinElmer sample preparation blocks are manufactured to specific tolerances which operates under a Quality Management System that is certified ISO 9001:2008.

Features and Benefits

- Ideal for any digestion/heating method which requires a temperature below 180 °C.
- Provides uniform temperature (± 1.0 °C across the block).
- Delivers even sample evaporation results.
- PTFE-coated graphite block resists aggressive, corrosive attack.
- Choose from 8 different SPB blocks.

“The major advantage of the PerkinElmer Sample Preparation Block is its ability to provide me with accurate temperature across the entire block.

With every run, I am confident that I have excellent recovery rates from my samples and there is no chance of contamination – which is critical when I'm conducting lead testing on my ICP-AES.”

Michigan Department of Community Health
Mark Knottnerus
Trace Metals Manager

Sample Preparation Blocks

The SPB series of block digestion systems offers the latest in graphite block technology in many different packages. Graphite blocks are PTFE-coated to resist aggressive corrosive attack for guaranteed long life in harsh laboratory environments.

Our sample blocks operate with either a SPB Digital Controller or SPB Touch Controller*. Please select a controller below and the appropriate Start Up Kit* which includes RackLock DigiTUBE®, disposable watch glasses, DigiFILTER™s and much more. Each SPB Block includes one set of racks.

Sample Preparation Blocks

Description	Capacity	Part No.
SPB 15-40, (115 V/230 V)	40 Tubes/15 mL	N9308709
SPB 15-108, (115 V/230 V)	108 Tubes/15 mL	N9308710
SPB 50-24, (115 V/230 V)	24 Tubes/50 mL	N9308019
SPB 100-12, (115 V/230 V)	12 Tubes/100 mL	N9308010
SPB 50-48, (115 V/230 V)	48 Tubes/50 mL	N9308004
SPB 100-30, (115 V/230 V)	30 Tubes/100 mL	N9308012
SPB 50-72, (230 V)	72 Tubes/50 mL	N9308005
SPB 100-42, (230 V)	42 Tubes/100 mL	N9308014

*sold separately.



Controllers

The user friendly SPB Digital Controller includes programmable features such as: temperature set-point to 0.1 °C, even sample heating and evaporation results, timer shutdown option, and programmable alarm for end of cycle.

The SPB Touch Controller includes all of the SPB Digital Controller features and more. Added features include: a graphical representation of the heating profile in real-time to identify the current stage of the method heating program. Safety features include the ability of the controller to monitor the heating cycle of the block to prevent run away situations. The controller allows for the SPB Probe to be calibrated to meet your SOP requirements.

The SPB Probe, used with either the Digital or Touch models, can directly monitor and control the block's heating rate via sample temperature feedback to the controller.

Controllers

Description	Part No.
SPB Digital Controller	N9308006
SPB Touch Controller	N9308007



Start Up Kits

PerkinElmer's SPB Start Up kits contain all consumable items required to operate the system including: RackLock DigiTUBE[®]s and Caps, disposable Watch Glasses, DigiFILTER[™]s, RackLock Racks and Storage Racks.

Start Up Kits

Description	DigiTUBE [®] s/ Caps	Watch Glasses	Racks	Part No.
Start Up Kit for SPB 15-40	540		2	N9308704
Start Up Kit for SPB 15-108	540		2	N9308706
Start Up Kit for SPB 50-24	500	1000	1	N9308017
Start Up Kit for SPB 100-12	200	500	1	N9308011
Start Up Kit for SPB 50-48	500	1000	2	N9308002
Start Up Kit for SPB 100-30	200	500	2	N9308013
Start Up Kit for SPB 50-72	500	1000	3	N9308025
Start Up Kit for SPB 100-42	200	500	2	N9308015



DigiFILTER[™]

The vacuum assisted DigiFILTER[™] assembly provides a quick and easy way to filter samples prior to analysis. Increase lab productivity by filtering particulates from digested samples in a matter of seconds directly from the digestion tube. Available with a 0.45 or 1.0 micron hydrophilic PTFE membrane. Field Filtration Kit conforms to Item 8.2 in the EPA 200.7, 200.8 and 200.9 Methods.

DigiFILTERs[™]

Description	Quantity	Part No.
DigiFILTER [™] 0.45 micron for 50 mL DigiTUBE [®] s	100	N9308031
DigiFILTER [™] 1.0 micron for 50 mL DigiTUBE [®] s	100	N9308032
Field Filtration Kit 0.45 for 50 mL DigiTUBE [®] s*	1	N9308033
DigiFILTER [™] Manifold	1	N9308034

*Contains: 25 DigiFILTER[™]s, 30 DigiTUBE[®]s, 1x 6 mL eyedropper bottle to dispense 2 to 3 drops of (1+1) PlasmaPURE[®] Nitric acid, 1 storage rack, 1 Sharpie[®] pen and 2x 60 mL plastic syringes to create a vacuum to filter samples from the collection vessel to the sample tube.

Tubes, Caps and Watch Glasses

Why use a thermometer to monitor and manually adjust sample temperature when a SPB Probe will automatically do the job? The SPB Probe provides direct control and monitoring of actual sample temperature via a corrosion-resistant, PFA-coated temperature probe. Available with different holders in a 6" configuration for use with 50 and 100 mL DigiTUBE[®]s. Each probe is supplied with 5 Probe Watch Glasses and a probe holder.



Tubes, Caps and Watch Glasses

Description	Quantity	Part No.
Tubes		
DigiTUBE [®] s 15 mL with RackLock (incl. caps)	1620	N9308711
DigiTUBE [®] s 15 mL with RackLock (no caps)	1620	N9308712
DigiTUBE [®] s 15 mL with RackLock (incl. caps)	540	N9308713
DigiTUBE [®] s 50 mL with RackLock (incl. caps)	750	N9308008
DigiTUBE [®] s 50 mL with RackLock (no caps)	750	N9308340
DigiTUBE [®] s 50 mL with non-RackLock (incl. caps)	750	N9308037
DigiTUBE [®] s 100 mL with RackLock (incl. caps)	300	N9308016
DigiTUBE [®] s 100 mL with non-RackLock (incl. caps)	300	N9308066
PTFE Digestion Tube 50 mL (incl. blue caps)	6	N9308024
Tube, Quartz, 62.5 mL, Uncalibrated	6	N9308048
Tube, Borosilicate, 62.5 mL, Uncalibrated	6	N9308049
Tube, Borosilicate, 62.5 mL, Calibrated at 50 mL	6	N9308050
Caps		
Screw Caps, Blue, for 15 mL DigiTUBE [®] s	540	N9308705
Screw Caps, Clear, for 15 mL DigiTUBE [®] s	540	N9308708
Screw Caps, Orange, for 50 mL DigiTUBE [®] s	250	N9308058
Screw Caps, Red, for 50 mL DigiTUBE [®] s	250	N9308059
Screw Caps, Clear, for 50 mL DigiTUBE [®] s	250	N9308060
Screw Caps, Yellow, for 50 mL DigiTUBE [®] s	250	N9308056
PTFE Screw Cap for PTFE 50 mL, N9308024 replaces blue caps supplied	6	N9308027
Watch Glasses		
Disposable Watch Glasses, 50 mL	1000	N9308003
Disposable Watch Glasses, 100 mL	500	N9308030

DigiTUBE[®] Dimensions

Tube	Outside	Inside
15 mL DigiTUBE [®]	1.2 cm	1.1 cm
50 mL DigiTUBE [®]	30 mm	28 mm
100 mL DigiTUBE [®]	46 mm	44 mm



Temperature Probes

Why use a thermometer to monitor and manually adjust sample temperature when a SPB Probe will automatically do the job? The SPB Probe provides direct control and monitoring of actual sample temperature via a corrosion-resistant, PFA-coated temperature probe. Available with different holders in a 6" configuration for use with 50 and 100 mL DigiTUBE®s. Each probe is supplied with 5 Probe Watch Glasses and a probe holder.

Temperature Probes

Description	Quantity	Part No.
SPB Probe 6" for 15 mL Tubes	1	N9308707
SPB Probe 6" for 50 mL Tubes	1	N9308018
SPB Probe 6" for 100 mL Tubes	1	N9308009
SPB Probe Watch Glass (replacement) for 50 mL Tubes	25	N9308041
SPB Probe Watch Glass (replacement) for 100 mL Tubes	25	N9308073
SPB Probe Holder for DigiTUBES 15 mL	1	N9308703
SPB Probe Holder for DigiTUBES 50 mL	1	N9308044
SPB Probe Holder for DigiTUBES 100 mL	1	N9308045



Racks

For busy labs, additional acid resistant, polycarbonate Racks are available for all SPB systems. Exclusive RackLock feature locks DigiTUBE®s in position within the rack allowing for easy, one-handed closure of screw cap.

SPB Block Racks

Description	Quantity	Part No.
40 Position Rack for SPB 15-40, 15 mL	1	N9308700
54 Position Rack for SPB 15-108, 15 mL	1	N9308701
12 position Rack for SPB-100-12, 100 mL	1	N9308067
15 position Rack for SPB-100-30, 100 mL	1	N9308068
21 position Rack for SPB-100-42, 100 mL	1	N9308069
24 position Rack for SPB-50-24, 50 mL	1	N9308070
24 position Rack for SPB-50-48 and SPB-50-72, 50 mL	1	N9308042

Storage Racks

Description	Quantity	Part No.
Foam Storage Rack 15 mL	5	N9308702
Plastic Storage Rack 50 mL	5	N9308381
Foam Storage Rack 100 mL	5	N9308382

Automatic Shut-Off System



Designed to shut-off SPB systems with no lab supervision. Ideal for overnight digestions and evaporations where samples require volume reductions (volume control ± 2.5 mL). Increase lab efficiency by automatically digesting samples off-hours. Select appropriate Probe for Tube use.

Controllers

Description	Quantity	Part No.
TempSET, without Probe	1	N9308020
TempSET Probe for 50 mL Tubes	1	N9308023
TempSET Probe for 100 mL Tubes	1	N9308029
TempSET Probe Holder for 100 mL Tubes	1	N9308065

Fume Hoods and Accessories



The bench top fume hoods for SPB systems are the right choice for trace-metal digestions. Made from clear, acid resistant polycarbonate with a solid surface material base, the fume hood eliminates the risk of trace-metal contamination common with traditional fume hoods. HEPA® filters ensure clean input air. The fume hood can be connected to an in-house laboratory exhaust system or used with the SPB blower unit (N9308022). Fume hoods come flatpacked to save transport costs and can be assembled in minutes without tools.

Fume Hoods and Accessories

Description	Part No.
Fume Hood for SPB 50-24/100-12, 50-48/100-30	N9308000
Fume Hood for SPB 50-72/100-42 - Filter for SPB Fume Hoods N9308078	N9308001
Fume Hood II for AutoSampler	N9308036
DigiVAC™ Evacuation Hood, mounts directly on SPB 50-48/SPB 100-30	N9308021
SPB Blower Unit, for use with all systems	N9308022

GREAT RESULTS BEGIN WITH GOOD PREPARATION



Titan MPS™ Microwave Sample Preparation System

PerkinElmer offers the Titan MPS microwave sample preparation systems, consumables and accessories for your lab needs.

Microwave digestion provides the high-temperature, high-pressure digestion needed to deliver quick, complete sample digestion of the most difficult samples and allow for total elemental analysis. Using ultra-clean sealed digestion vessels, the Titan MPS avoids loss of volatile analytes and prevents sample contamination from the working environment. With its high performance, microwave digestion is ideal for nearly any sample including those from the challenging mining/geologic, metallurgical, environmental, petrochemical and pharmaceutical industries.

The Titan MPS microwave sample preparation system delivers the instrument-ready solutions you need for high throughput and reliable results. Using our Direct Pressure Control™ (DPC) and Direct Temperature Control™ (DTC) sensing technologies, the Titan MPS system accurately monitors digestion reactions and the sample temperature in each digestion vessel to provide outstanding reaction control and deliver consistent digestion results.

With the Titan MPS microwave sample preparation system, we're delivering on the promise of a simple, safe, cost-effective microwave – one that provides the quick return on investment that labs are looking for in these times of constrained budgets. And it's backed by PerkinElmer, the one-stop, go-to resource for all things atomic spectroscopy. With a team of support individuals who understand, in a deep-seated way, the science behind the goals your lab is trying to achieve.

The Titan MPS microwave sample preparation system. Yes, it's a microwave. But we think it's a whole lot more.

Features:

- A top-loading system that allows the easy loading and removal of vessels.
- The DTC and DPC optical temperature and pressure reaction monitoring technologies and a cylindrical oven chamber ensure the most reproducible results.
- Vessels are reusable and guaranteed for one year, for considerable savings on consumables.
- Integrated gas collection system efficiently vents the oven chamber to keep it free of gas or acidic vapors.
- Color touch-screen controller simplifies programming, data storage, and reaction control.
- The PFA-coated stainless steel body and lid, safety interlocks and unique vessels deliver the highest level of operator safety and unprecedented corrosion resistance.

Titan MPS Systems

Before you prepare your first sample, you'll notice the difference: The Titan MPS is a top-loading microwave sample preparation system protected by hardware interlocks to ensure safety during operation. And it's simple to load and unload samples, which keeps everyone more productive – and saves your lab time and money.

Titan MPS 16 Position



Includes: 16 position turntable, gas containment manifold, 16 standard pressure 75 mL digestion vessels, 15 vessel caps without pressure sensor, 1 vessel cap with pressure sensor, a lip seal forming tool, exhaust hose, consumables kit, and power cord (US)

Weight: 53 kg

Dimensions (WxDxH): 21 in. x 25 in. x 17 in.

Description	Part No.
Titan MPS 16 Position, (230V 50/60Hz)	N3130100

Titan MPS 8 Position



Includes: 8 position turntable, gas containment manifold, 8 high pressure 100 mL digestion vessels, 8 TFM sample vessel inserts, 8 ceramic pressure jackets, 7 Vessel Caps without pressure sensor, 1 vessel cap with pressure sensor, a vessel opening station, a lip seal forming tool, exhaust hose, consumables kit, and power cord (US)

Weight: 53 kg

Dimensions (WxDxH): 21 in. x 25 in. x 17 in.

Description	Part No.
Titan MPS 8 Position, (230V 50/60Hz)	N3130110

System Accessories



External Exhaust System

Optional accessory for exhausting Titan MPS oven cavity in laboratories that do not have exhaust systems.

Includes: one 1.5 m exhaust tube. ID = 76 mm, OD = 82 mm. and power cord (US)

Description	Part No.
External Exhaust System 230V 50/60 Hz	N3131009

Exhaust Tubes



Description	Part No.
Exhaust Tube 1.5 m (one included with Titan)	N3134015
Exhaust Tube 3 m (optional if longer is required)	N3134064

Titan MPS Bench



The Titan MPS bench is a heavy-duty Chemsurf laminated rolling cart. The top working surface is constructed with durable Chemsurf material, a chemically-resistant laminate specifically designed for applications in laboratories with routine exposure to chemicals. A full lower shelf with durable Chemsurf laminate provides storage space for digestion vessels and other Titan MPS spares and accessories. Locking 4" diameter casters provide stability and easy movement.

Dimensions: 32"D x 30"W x 29"H

Description	Part No.
Titan MPS Bench	N0777900



Turntables

Description	Part No.
16 Position	
16 position turntable with Standard 75 mL (40 Bar) Digestion Vessels, with DPC (complete)	N3131010
16 position turntable with Standard 75 mL (40 Bar) Digestion Vessels, without DPC (complete)	N3131005
16 position turntable for Standard 75 mL (40 Bar) Digestion Vessels (turntable only)	N3131006
8 Position	
8 position turntable with High Pressure 100 mL (100 Bar) Digestion Vessels, with DPC (complete)	N3131011
8 position turntable with High Pressure 100 mL (100 Bar) Digestion Vessels, without DPC (complete)	N3131007
8 position turntable for High Pressure 100 mL (100 Bar) Digestion Vessels (turntable only)	N3131008



Vessels and Spares

Description	Part No.
Standard (All Part No. Quantities are 1)	
Standard 75 mL (40 Bar) Digestion Vessel without DPC Consists of: Pressure seal, Vessel cap, Rupture disc and Vessel base	N3132009
Standard 75 mL (40 Bar) Digestion Vessel with DPC (Complete) Consists of: Pressure seal, Vessel cap with DPC, Rupture disc and Vessel base	N3132010
Standard 75 mL (40 Bar) Digestion Vessel TFM Base (base only)	N3132011
TFM Cap for Standard 75 mL (40 Bar) Digestion vessels without pressure sensor	N3132012
TFM DPC Cap for Standard 75 mL (40 Bar) Digestion vessels with pressure sensor	N3132013
High Pressure (All Part No. Quantities are 1)	
High Pressure 100 mL (100 Bar) Digestion Vessel without DPC (complete) Consists of: Pressure seal, Vessel cap, Rupture disc, TFM Vessel insert, Ceramic pressure jacket and Vessel base	N3133012
High Pressure 100 mL (100 Bar) Digestion Vessel with DPC (complete) Consists of: Pressure seal, Closure cap with DPC, Rupture disc, TFM Vessel insert, Ceramic pressure jacket and Vessel base	N3133013
High Pressure 100 mL (100 Bar) Digestion Vessel Base (base only)	N3133014
TFM Cap for High Pressure 100 mL (100 Bar) Digestion Vessels without pressure sensor	N3133015
TFM DPC for high pressure 100 mL (100 Bar) Digestion Vessels with pressure sensor	N3133016



Consumable Kits

Description	Part No.
Consumable Kit for Standard 75 mL Digestion Vessels	
Consumable Kit for Standard 75 mL (40 Bar) Digestion Vessels	N3132000

Includes: 10 Pressure Seals (N3132002), 4 Rupture Cap Discs (N3132001), and 5 Lip Seal Rings of the Gas Containment Manifold (N3134000)

Description	Part No.
Consumable Kit for High Pressure 100 mL Digestion Vessels	
Consumable Kit for High Pressure 100 mL (100 Bar) Digestion Vessels	N3133024

Includes: 10 Pressure Seals (N31330203), 7 Rupture Cap Discs (N3133022), 50 PEEK Ring Nuts (N3133011), and 5 Lip Seal Rings of the Gas Containment Manifold (N3134000)



Spares and Replacement Parts

Description	Part No.
Rupture Disc for Standard 75 mL (40 Bar) Digestion Vessels Made of aluminum, set of 25 pcs	N3132001
Pressure Seal for Standard 75 mL (40 Bar) Digestion Vessels Made of TFM, set of 10 pcs	N3132002
DPC Glass-Ring for Standard 75 mL (40 Bar) Digestion Vessel	N3132003
DPC Glass Prism for Standard 75 mL (40 Bar) Digestion Vessel	N3132004
DPC Polarization foil for Digestion Vessel caps with pressure control for Standard 75 mL (40 Bar) and High Pressure 100 mL (100 Bar) Digestion Vessel, set of 24 pcs	N3132005
DPC TFM Cap Insert for Standard 75 mL (40 Bar) Digestion Vessel	N3132006
DPC Clamp Screw for Glass Prism for Standard 75 mL (40 Bar) Digestion Vessel	N3132007
DPC Viton O-Ring (25 x 3 mm) for Digestion Vessel caps with pressure control for Standard 75 mL (40 Bar) Digestion Vessel, qty 1. Two are required per vessel cap	N3132008
Rupture Disc for High Pressure 100 mL (100 Bar) Digestion Vessels Made of titanium, set of 10 pcs	N3133022
Pressure Seal for High Pressure 100 mL (100 Bar) Digestion Vessels Made of TFM, set of 5 pcs	N3133023
DPC Glass-Ring for High Pressure 100 mL (100 Bar) Digestion Vessel	N3133003
DPC Glass Prism for High Pressure 100 mL (100 Bar) Digestion Vessel	N3132004
DPC TFM Cap Insert for High Pressure 100 mL (100 Bar) Digestion Vessel	N3133006
DPC Clamp Screw for Glass Prism for High Pressure 100 mL (100 Bar) Digestion Vessel	N3133007
DPC O-Ring for Digestion Vessel Caps with pressure control for High Pressure 100 mL (100 Bar) Digestion Vessel, qty 1. Two are required per vessel cap	N3133008
DPC Polarization foil for Digestion Vessel caps with pressure control for Standard 75 mL (40 Bar) and High Pressure 100 mL (100 Bar) Digestion Vessel, set of 24 pcs	N3132005



TFM Sample Vessel Insert for High Pressure 100 mL (100 Bar) Digestion Vessel	N3133009
Ceramic Pressure Jacket for High Pressure 100 mL (100 Bar) Digestion Vessel	N3133010
PEEK Ring Nut for High Pressure 100 mL (100 Bar) Digestion Vessel closure cap. (Left handed threads)	N3133011
PEEK Ring Nut Removal Tool for 100 mL	N3133021



Gas Containment Manifold Spares

Description	Part No.
End Cap Plug for Gas Containment Manifold Sealing plug for 8 and 16 position Gas Containment Manifold to seal the gas collection system at unused vessel positions	N3134004
Clamping Screw (PTFE) for the top seal of the 8 and 16 position Gas Containment Manifold	N3134002
Lip Seal Ring of the Gas Containment Manifold PTFE Sealing Ring for use with 8 and 16 position Gas Containment Manifolds Seals the top PFA gas tube to the Gas Containment Manifold	N3134000
Tube for connection of vessel to Gas Containment Manifold (PTFE) PTFE connecting tube for connection to digestion vessels with 8 and 16 position Gas Containment Manifold	N3134005
PTFE connector for use with 8 and 16 position Gas Containment Manifold	N3134007
Gas Containment Manifold PFA Vent Line 1M (O-Ring in picture not included)	N3134014
Gas Containment Manifold Vent Line replacement O-Ring (Qty. 2)	N3134072



Accessories

Description	Part No.
Single lip seal forming tool for Standard 75 mL (40 Bar) Digestion Vessel pressure seals	N3132015
Eight position lip seal forming tool for Standard 75 mL (40 Bar) Digestion Vessel pressure seals Forms up to 8 seals simultaneously	N3132014
Vessel cap disassembly tools for Standard 75 mL (40 Bar) Digestion Vessel	N3134011
High Pressure 100 mL (100 Bar) Digestion Vessel opening station	N3133017
Eight position lip seal forming tool for High Pressure 100 mL (100 Bar) Digestion Vessel pressure seals	N3133018
Single lip seal forming tool for High Pressure 100 mL (100 Bar) Digestion Vessel pressure seals Forms 1 seal	N3133019
Vessel cap disassembly tools for High Pressure 100 mL (100 Bar) Digestion Vessel	N3134012
PTFE 2 mL sample weighing cup for use in Standard 75 mL (40 Bar) or High Pressure 100 mL (100 Bar) Digestion Vessel, qty. 1	N3134009
PTFE 2 mL sample weighing cup for use in Standard 75 mL (40 Bar) or High Pressure 100 mL (100 Bar) Digestion Vessel, qty. 16	N3134010
Turntable Base Ring	N3134013

HUMAN HEALTH

ENVIRONMENTAL HEALTH



LEAPFROGGING EVERYONE IN SENSITIVITY AND STABILITY



CLARUS SQ 8 GC/MS

Experience world-leading performance with the new Clarus® SQ 8 GC/MS.

Engineered around the industry's most sensitive, long-lasting Clarifi™ detector and a unique SMARTsource™, the revolutionary Clarus SQ 8 has leapt to the front of the pack in GC/MS. No other instrument comes close to its detection limits, mass range or long-term stability. Nothing delivers greater confidence in your results, or greater productivity in your lab. Visit www.perkinelmer.com/ClarusGCMS. And take a giant leap forward with the Clarus SQ 8.

www.perkinelmer.com/ClarusGCMS

PerkinElmer[®]
For the Better



CHROMATOGRAPHY

PerkinElmer has been a leading provider of Chromatography solutions for over 50 years. Our team of dedicated Chromatography Specialists has an expertise that boasts years of knowledge in understanding a laboratory's product requirements. This knowledge allows us to give you a focused consumables portfolio to fit your applications. From colored inlet liners that help you easily identify the correct liner for your application to gas purification systems that remove up to 99.99% of contaminants, our precision-designed, genuine tested and approved consumables will provide you with solid, reliable support, giving you all you need to succeed. But our solutions don't stop there.

At PerkinElmer, we're committed to providing you with the best selection of solutions for all your Chromatography needs, regardless of make, model or manufacturer. We have invested heavily in growing our portfolio, at your request, to bring you the best performing and productivity enhancing consumables and accessories for all your gas chromatograph systems.

Sample Preparation

Crimping Tools and Vial Accessories	121
QuEChERS Dispersive SPE	110-111
Solid Phase Extraction (SPE)	101-109
Syringes	112
Syringe Filters	100
Vials, Caps and Septa	113-120

Our consumables can be depended upon to meet the most demanding performance and throughput needs for today's analytical, process monitoring and quality control facilities.

Liquid Chromatography

Autosamplers and Accessories	164-165
Columns - Cartridge	144-153
Columns - Cartridge Holders	153
Columns - Conventional	127-141
Columns- Conventional Guard Columns	142-143
Columns - SPP	124-126
Detector Lamps	155
Fittings	162
Flexar Consumables and Accessories	122-123
Flexar Supplies and Accessories	166-168
Flow Cells and Pump Accessory Kits	154
Injection Valves and Rotor Seals	163
Nitrogen Generators	169-171
Pumps	158-160
Sample Loops and Tubing	161
Vacuum Degassing Kits	156-157

Gas Chromatography

Autosampler Parts and Accessories	228
Capillary Columns	172 - 196
Capillary Columns - Arnel Analyzers	198
Capillary Columns - Cross Reference	174-175
Capillary Columns - General Purpose	176-188
Capillary Columns - Specialty Phase	189-195
Calibration Gas Blends - Arnel Analyzers	199
Custom Packed Columns	197
Detectors	214-220
Ferrules and Connectors	200
Fittings	201
Gas Management - Compressors	240
Gas Management - Filters	229-233
Gas Management - Flow Meters	243
Gas Management - Hydrogen Generators	234-237
Gas Management - Leak Detectors	242
Gas Management - Regulators	241
Gas Management - Zero Air Generators	238-239
Injection Port Septum	213
Injectors	204-209
Liners	210-211
Marathon Filament	221
Organic Standards	244-245
SMARTSource	222-223
Swafer	202-203
Syringes	212
Thermal Desorber Consumables	224-227

TESTED AND APPROVED



Syringe Filters

Our Syringe Filters are lab tested and certified to bring you the highest quality syringe filters available. Our membrane materials are supplied per ISO9001:2008 certified manufacturing practices, in certified clean room conditions, using the latest manufacturing technology to ensure you receive a high quality, consistent product every time.

Our superior premium 17 and 30 mm filters are suitable for coarse/crude samples or higher detection limit applications (such as food, beverage, or environmental analysis). Our 4, 13 and 25 mm syringe filters are ideal for routine QA/QC analysis

Nylon Syringe Filters

Ideal for aqueous (non-acidic) or organic sample preparation and HPLC, GC or dissolution sample analysis. With its excellent flow characteristics, very low extractable levels and mechanical stability, Nylon offers the best combination of physical parameters to meet the most stringent analytical needs.

Size	Pack Size	Color	0.22 µm Particle Part No.	0.45 µm Particle Part No.
4 mm	200	Clear	02542900	02542901
13 mm	100	Purple	02542902	02542903
17 mm	100	Yellow	02542881	02542880
25 mm	100	Purple	02542904	02542905
30 mm	100	Yellow	02542883	02542882

PTFE (Hydrophobic) Syringe Filters

Versatile filters for use with aggressive organic solvent-based solutions and are especially ideal for HPLC sample preparation. Hydrophobic PTFE syringe filters have broad chemical compatibility and high pH resistance.

Size	Pack Size	Color	0.22 µm Particle Part No.	0.45 µm Particle Part No.
4 mm	200	Clear	02542906	02542907
13 mm	100	Red	02542908	02542909
17 mm	100	Red	02542884	02542910
25 mm	100	Red	02542911	02542912
30 mm	100	Red	02542886	02542885

PVDF (Hydrophobic Polyvinylidene Fluoride) Syringe Filters

Ideal for a wide range of mild organic solutions. PVDF membranes are not recommended for use with acetone, DMF, DMSO, or bases >6N.

Size	Pack Size	Color	0.22 µm Particle Part No.	0.45 µm Particle Part No.
4 mm	200	Clear	02542913	02542914
13 mm	100	Yellow	02542915	02542783
17 mm	100	Maroon	02542916	02542917
25 mm	100	Yellow	02542918	02542919
30 mm	100	Maroon	02542920	02542921

PTFE (Hydrophilic) Syringe Filters

Versatile filters for use with aqueous and aggressive organic solvent-based solutions and are especially ideal for HPLC sample preparation. They have broad chemical compatibility and high pH resistance.

Size	Pack Size	Color	0.22 µm Particle Part No.	0.45 µm Particle Part No.
4 mm	200	Clear	02542922	02542923
13 mm	100	Red	02542924	02542925
25 mm	100	Red	02542926	02542927
30 mm	100	Red	02542928	02542929

SUPERIOR REPRODUCIBILITY SUPERIOR RESULTS



Supra-Clean and Supra-Poly SPE Solutions

Manufactured for guaranteed reproducibility and superior performance, this innovative line of SPE solutions includes the Supra-Clean® silica based and Supra-Poly® polymer based line of spherical media SPE cartridges and columns.

Both utilize Precise Bed Technology® allowing columns to be evenly and consistently filled with particles sized for optimum distribution. This homogeneous filling yields a +/- 1% variation in bed volume precision, ensuring you experience repeatability and optimized recovery reproducibility.

Ideal for a broad array of analytes and matrices, SPE solutions are available in a variety of formats including Large Reservoir Capacity (LRC) columns, Polypropylene (PP) columns and cartridges, and glass columns. Each technology is offered with a wide selection of polymer and silica sorbents, and large and small sample volumes (50µL-1L) allow you to perform scalable analyses depending upon your required detection limits.

Each finished product is delivered with an individual quality certificate.

SPE Manifolds, Selection Kits and Application Packs

For greater method development simplicity and sample throughput, PerkinElmer offers a variety of pre-prepared column selection kits as well as application kits for you to choose from.

SPE Manifolds:

- Allow you to process up to 24 samples simultaneously
- Seamlessly integrate with columns to extend the system's performance and reproducibility
- Feature polypropylene or stainless steel needle valves and tips with minimum dead volume
- Rugged stopcocks are reusable and provide independent flow control

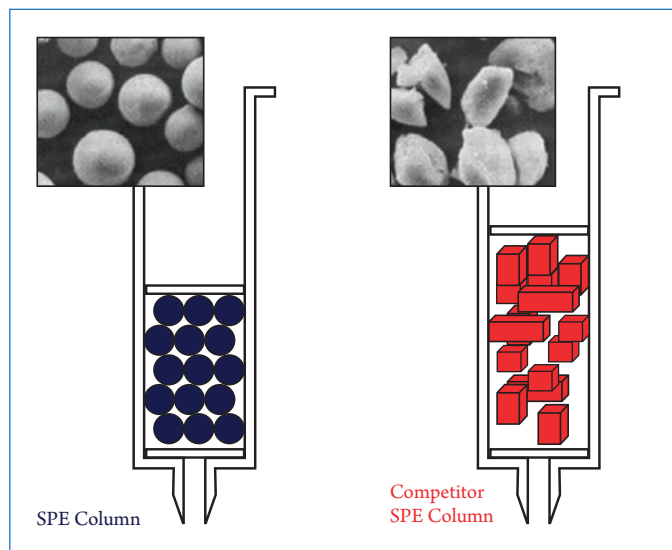

Spherical media and consistent particle distribution enable smaller elution volumes and better, more reproducible extraction, purification, concentration and recovery.

Performance Comparison of PerkinElmer Spherical SPE Media vs. Leading Irregular SPE Silica.

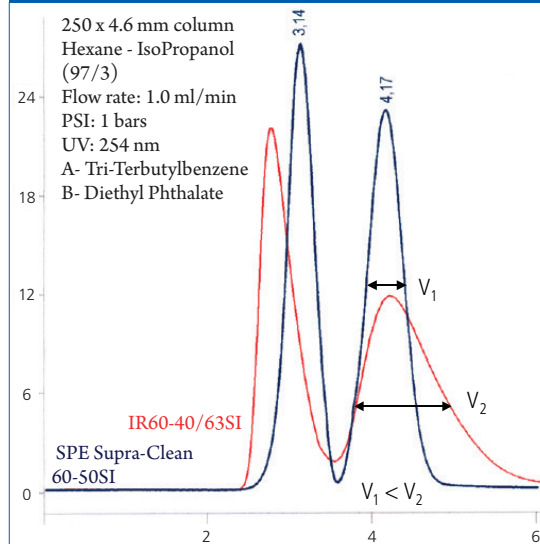

PerkinElmer's smaller, more homogeneous, spherical media deliver sharper, narrower peaks for faster, more accurate sample analysis.

A WIDE ARRAY OF COLUMNS FOR A BROAD RANGE OF APPLICATIONS

SUPRA-CLEAN SPHERICAL SILICA				
Phase	Mechanism	Interaction mode	Compounds	Matrix
C18-S	Hydrophobic	Reversed Phase	Polar to Non-Polar compounds	Biological fluids, aqueous samples
High Recovery REC18	Hydrophobic	Reversed Phase	Non-polar and mid-polar compounds including 100% water solvents	Biological fluids, aqueous samples toxins in food
Phenyl (PH-S)	Hydrophobic	Reversed Phase	Non-polar to mid-polar aromatic compounds	Biological fluids
Silica (SI-S)	Hydrophilic	Normal Phase	Polar compounds	Non-polar organics, oils, lipids
Amino (NH2-S)	Hydrophilic	Normal Phase	Polar to Mid-Polar aromatic compounds	Biological fluids, aqueous samples, buffered organics
Strong Cation Exchange (SCX)	Ion Exchange	Ion Exchange	Basic compounds	Biological fluids, aqueous samples, buffered organics
Weak cation Exchange (WCX)	Ion Exchange	Ion Exchange	Strong basic compounds	Biological fluids, aqueous samples
Strong Anion Exchange (SAX)	Ion Exchange	Ion Exchange	Acidic compounds	Biological fluids, aqueous samples
Cyano (CN-S)	Hydrophilic	Normal Phase	Polar to Mid-Polar compounds	Non-polar organics, oils, lipids
Florisil (FL-S)	Hydrophilic	Normal Phase	Polar compounds	Ideal for polar compounds in non-polar matrix
Florisil Pesticide (FL-S)	Hydrophilic	Normal Phase	Polar compounds	Ideal for polar compounds in non-polar matrix
Polyamine (P6)	Hydrophilic	Reversed Phase	Carboxylic acids, phenolics and nitroaromatics	Aqueous and mid-polar matrices
300 A (C4)	Hydrophobic	Reversed Phase	Non-polar to mid-polar compounds	Biological Samples
LCC	Hydrophobic	Reversed Phase	Non-polar to mid-polar compounds	Biological fluids, aqueous samples
Mixed mode (MM1)	Ion Exchange/ Hydrophobic	Reversed Phase / SCX	Basic compounds	Biological samples
Mixed mode (MM2)	Ion Exchange/ Hydrophobic	Reversed Phase / WCX	Very basic compounds	Biological samples
Mixed mode (MM3)	Ion Exchange/ Hydrophobic	Reversed Phase / SAX	Acidic compounds	Biological samples
SUPRA-POLY SPHERICAL POLYMER				
Extreme Capacity (XC)	Hydrophobic	Reversed Phase	Polar and non-polar	Aqueous or organic
Extreme Capacity Wide Pore (XWP)	Hydrophobic	Reversed Phase	Polar and non-polar	Biological and viscous samples
Hydrophilic (ATH)	Hydrophilic	Reversed Phase	Mid to non-polar compounds	Aqueous or organic
Lipophilic (ATL)	Lipophilic	Reversed Phase	Mid to non-polar compounds	Crude samples
Environmental (AEV)	Hydrophilic/ Hydrophobic	Reversed Phase	Mid to non-polar compounds	Aqueous or Organic
HLB	Hydrophilic/lipophilic balanced	Reversed Phase	Mid to non-polar compounds	Aqueous or organic



Typical Applications	pH Range	End-capping	Pore Size (Å)	Surface Area (m ² /g)	Particle Size (µm)	Comments
Drugs and drug metabolites in biological matrices, trace organic material in water, toxins in food	2-8	Yes	60	500	50	18% Carbon Load (CL)
Drugs and drug metabolites in biological matrices, trace organic material in water,	2-8	Yes	NA	NA	50	High capacity and better recovery especially for high aqueous conditions. 15% CL
Benzodiazepines in biological matrices, extraction of aromatic compounds	2-8	No	60	500	50	9% CL
Aldehydes, amines, pesticides, herbicides, carotenoids, fat soluble vitamins, aflatoxins, fatty acids, and phospholipids	2-8	No	60	500	50	Bare Silica
Basic compounds, polar amine compounds, carbohydrates	2-8	No	60	500	50	5% CL
Cations, antibiotics, drugs, amino acids, catecholamines, herbicides, nucleic acid bases, nucleosides, and surfactants	2-8	No	60	450	60	Strong Acid - Sulfonic acid; Exchange capacity 0.70 meq/g
Cations, amines, antibiotics, drugs, amino acids, catecholamines, nucleic acid bases, nucleosides, and surfactants	2-8	No	60	450	60	Weak Acid - Carboxylic acid; Exchange capacity 0.22 meq/g
Acidic food pigments, organic acids, phenol compounds, nucleic acids, nucleotides, surfactants	2-8	No	60	450	60	Strong Base - quaternary amine; Exchange capacity 0.30 meq/g
Polar compounds in hexane and oil	2-8	Yes	60	500	50	8% CL; Mid-range polarity between silica and C18
Pesticides, Polychlorinated Biphenyls (PCB)	2-8	No	NA	NA	200	Standard grade. Alternative to silica for viscous matrices due to large particle size.
Pesticides	2-8	No	NA	NA	200	High purity pesticide grade. Alternative to silica for viscous matrices
Aromatic and natural products; Flavones, Chalkones, Anthraquinones	2-8	No	NA	NA	100	Nylon 6
Hydrophobic peptides and polypeptides	2-8	No	300	-	-	Large pore size for isolation of large biomolecules
Non-polar compounds in aqueous solution	2-8	Yes	60	500	50	10% CL; Lower carbon load than C18-S and REC18
Drugs and drug metabolites	2-8	No	60	450	60	Exchange capacity 0.09 meq/g
Drugs and drug metabolites	2-8	No	60	450	60	Exchange capacity 0.10 meq/g
Drugs and drug metabolites	2-8	No	60	450	60	Exchange capacity 0.14 meq/g
Drugs and drug metabolites biological fluids	0-14	No	NA	1500	70	High capacity polystyrene-divinylbenzene (PSDVB)
Drugs and drug metabolites biological fluids	0-14	No	Wide Pore	1200	90	High capacity PSDVB for large biomolecules and viscous matrices
Mid-polar and non-polar compounds in aqueous and organic solvents	1-13	No	70	800	75	Mixed hydrophilic/hydrophobic interactions
Lipids	0-14	No	70	800	100	PSDVB; Alternative to high flow silica for mid-polar to non-polar compounds (<3000D) in crude samples
Aqueous environmental compounds that are not retained on C18	1-12	No	70	800	75	Advanced environmental; Polystyrene-co-2-hydroxyethyl methacrylate (PSHEMA)
Mid-polar and non-polar compounds in aqueous and organic solvents	0-14	No	80	850	30 & 60	Hydrophilic-lipophilic-balanced reversed-phase sorbent for acids, bases and neutrals

SOLID PHASE EXTRACTION (SPE)



Supra-Clean Columns, Cartridges and 96 Well Plates:

- Pure spherical silica
- Pore size 60 - 120 Å
- 20 chemistries with pH range 2-8

Supra-Clean C18

Columns

Media Weight	Volume	Quantity	Part No.
50 mg	1 ml	50	N9306476
100 mg	1 ml	100	N9306478
100 mg	3 ml	50	N9306523
200 mg	3 ml	50	N9306462
500 mg	3 ml	50	N9306438
500 mg	3 ml*	50	N9306642
200 mg	6 ml	30	N9306634
500 mg	6 ml	30	N9306448
500 mg	6 ml*	30	N9306640
1 g	6 ml	30	N9306422
2 g	6 ml	30	N9306430
2 g	15 ml	20	N9306479
2 g	25 ml	20	N9306475

* Not end-capped

96 Well Plates

Media Weight	Volume	Quantity	Part No.
25 mg	2 ml	1	N9306566
50 mg	2 ml	1	N9306567
100 mg	2 ml	1	N9306568

Cartridges

Media Weight	Volume	Quantity	Part No.
390 mg		50	N9306587
910 mg		50	N9306588
1690 mg		50	N9306589

Supra-Clean REC18

Columns

Media Weight	Volume	Quantity	Part No.
50 mg	1 ml	50	N9306519
100 mg	1 ml	100	N9306520
100 mg	3 ml	50	N9306455
200 mg	3 ml	50	N9306521
500 mg	3 ml	50	N9306522
200 mg	6 ml	30	N9306633
500 mg	6 ml	30	N9306457
1 g	6 ml	30	N9306491

96 Well Plates

Media Weight	Volume	Quantity	Part No.
25 mg	2 ml	1	N9306563
50 mg	2 ml	1	N9306564
100 mg	2 ml	1	N9306565

Supra-Clean Strong Anion Exchange (SAX)

Columns

Media Weight	Volume	Quantity	Part No.
50 mg	1 ml	50	N9306553
100 mg	1 ml	100	N9306471
100 mg	3 ml	50	N9306554
200 mg	3 ml	50	N9306482
500 mg	3 ml	50	N9306555
500 mg	6 ml	30	N9306556

96 Well Plates

Media Weight	Volume	Quantity	Part No.
25 mg	2 ml	1	N9306581
50 mg	2 ml	1	N9306582
100 mg	2 ml	1	N9306583

Supra-Clean 300Å C4

Columns

Media Weight	Volume	Quantity	Part No.
50 mg	1 ml	50	N9306590
100 mg	1 ml	100	N9306591
100 mg	3 ml	50	N9306592
200 mg	3 ml	50	N9306593

Supra-Clean Strong Cation Exchange (SCX)

Columns

Media Weight	Volume	Quantity	Part No.
50 mg	1 ml	50	N9306536
100 mg	1 ml	100	N9306432
100 mg	3 ml	50	N9306537
200 mg	3 ml	50	N9306538
500 mg	3 ml	50	N9306539
500 mg	6 ml	30	N9306540

96 Well Plates

Media Weight	Volume	Quantity	Part No.
25 mg	2 ml	1	N9306575
50 mg	2 ml	1	N9306576
100 mg	2 ml	1	N9306577

Supra-Clean Weak Cation Exchange (WCX)

Columns

Media Weight	Volume	Quantity	Part No.
50 mg	1 ml	50	N9306544
100 mg	1 ml	100	N9306545
100 mg	3 ml	50	N9306546
200 mg	3 ml	50	N9306547
500 mg	3 ml	50	N9306420
500 mg	6 ml	30	N9306407

Supra-Clean Mixed-Mode (MM1)

Columns

Media Weight	Volume	Quantity	Part No.
50 mg	1 ml	50	N9306541
100 mg	1 ml	100	N9306542
100 mg	3 ml	50	N9306419
200 mg	3 ml	50	N9306543
500 mg	3 ml	50	N9306481
500 mg	6 ml	30	N9306416
200 mg	15 ml	50	N9306713

96 Well Plates

Media Weight	Volume	Quantity	Part No.
25 mg	2 ml	1	N9306578
50 mg	2 ml	1	N9306579
100 mg	2 ml	1	N9306580

Supra-Clean Mixed-Mode (MM2)

Columns

Media Weight	Volume	Quantity	Part No.
50 mg	1 ml	50	N9306548
100 mg	1 ml	100	N9306549
100 mg	3 ml	50	N9306550
200 mg	3 ml	50	N9306551
500 mg	3 ml	50	N9306411
500 mg	6 ml	30	N9306552

Supra-Clean Mixed-Mode (MM3)

Columns

Media Weight	Volume	Quantity	Part No.
500 mg	6 ml	30	N9306649

Supra-Clean Florisil (FL-S)

Columns

Media Weight	Volume	Quantity	Part No.
200 mg	3 ml	50	N9306511
500 mg	3 ml	50	N9306512
500 mg	6 ml	30	N9306494
1 g	6 ml	30	N9306413
2 g	6 ml	20	N9306513
2 g	15 ml	20	N9306514
2 g	25 ml	20	N9306515

Supra-Clean Florisil (FL-S) Pesticide Grade

Columns

Media Weight	Volume	Quantity	Part No.
200 mg	3 ml	50	N9306516
500 mg	3 ml	50	N9306400
500 mg	6 ml	30	N9306517
1 g	6 ml	30	N9306436
2 g	6 ml	30	N9306470
2 g	15 ml	20	N9306443
2 g	25 ml	20	N9306447

SOLID PHASE EXTRACTION (SPE)

Supra-Clean Silica (SI-S)

Columns

Media Weight	Volume	Quantity	Part No.
100 mg	3 ml	50	N9306532
200 mg	3 ml	50	N9306444
500 mg	3 ml	50	N9306402
500 mg	6 ml	30	N9306466
1 g	6 ml	30	N9306404
2 g	6 ml	20	N9306533
2 g	15 ml	20	N9306534
2 g	25 ml	20	N9306535

Cartridges

Media Weight	Volume	Quantity	Part No.
300 mg		50	N9306584
700 mg		50	N9306585
1300 mg		50	N9306586

Supra-Clean Cyano (CN-S)

Columns

Media Weight	Volume	Quantity	Part No.
500 mg	3 ml	50	N9306645
500 mg	6 ml	30	N9306644

Supra-Clean Amino (NH2-S)

Columns

Media Weight	Volume	Quantity	Part No.
50 mg	1 ml	50	N9306528
100 mg	1 ml	100	N9306410
100 mg	3 ml	50	N9306529
500 mg	3 ml	50	N9306414
200 mg	6 ml	50	N9306530
500 mg	6 ml	30	N9306531

96 Well Plates

Media Weight	Volume	Quantity	Part No.
25 mg	2 ml	1	N9306572
50 mg	2 ml	1	N9306573
100 mg	2 ml	1	N9306574

Supra-Clean Polyamine (P6)

Columns

Media Weight	Volume	Quantity	Part No.
500 mg	3 ml	50	N9306518
500 mg	6 ml	30	N9306434

Supra-Clean Phenyl (PH-S)

Columns

Media Weight	Volume	Quantity	Part No.
50 mg	1 ml	50	N9306401
100 mg	1 ml	100	N9306524
100 mg	3 ml	50	N9306525
200 mg	3 ml	50	N9306490
500 mg	3 ml	50	N9306421
500 mg	6 ml	30	N9306526
1 g	6 ml	30	N9306527

96 Well Plates

Media Weight	Volume	Quantity	Part No.
25 mg	2 ml	1	N9306569
50 mg	2 ml	1	N9306570
100 mg	2 ml	1	N9306571

Supra-Clean LCC

Columns

Media Weight	Volume	Quantity	Part No.
500 mg	3 ml	50	N9306643
500 mg	6 ml	30	N9306641

Supra-Poly HLB Columns and 96 Well Plates:

- Contains macro-porous polymers with ultra-pure, pharmaceutical grade spherical particles
- Shorter analysis times, greater load capacity and reduced solvent usage
- Ideal for high throughput assays

Supra-Poly HLB

30 µm Columns

Media Weight	Volume	Quantity	Part No.
30 mg	1 ml	50	N9306650
50 mg	1 ml	50	N9306655
60 mg	1 ml	50	N9306656
100 mg	1 ml	50	N9306657
30 mg	3 ml	50	N9306651
60 mg	3 ml	50	N9306658
100 mg	3 ml	50	N9306659
200 mg	3 ml	50	N9306660
500 mg	3 ml	30	N9306661
100 mg	6 ml*	30	N9306672
150 mg	6 ml	30	N9306662
200 mg	6 ml	30	N9306663
200 mg	6 ml*	30	N9306673
500 mg	6 ml*	30	N9306674
500 mg	6 ml	30	N9306664
500 mg	15 ml	20	N9306665
1 g	15 ml	20	N9306666
30 mg	15 ml**	50	N9306668
60 mg	15 ml**	50	N9306669
100 mg	15 ml**	50	N9306670
200 mg	15 ml**	50	N9306671
1 g	25 ml	20	N9306667

* Glass columns ** LRC columns

30 µm 96 Well Plates

Media Weight	Volume	Quantity	Part No.
30 mg	2 ml	1	N9306698
50 mg	2 ml	1	N9306699
60 mg	2 ml	1	N9306700

60 µm Columns

Media Weight	Volume	Quantity	Part No.
30 mg	1 ml	50	N9306652
50 mg	1 ml	50	N9306675
60 mg	1 ml	50	N9306676
100 mg	1 ml	50	N9306677
30 mg	3 ml	50	N9306653
60 mg	3 ml	50	N9306678
100 mg	3 ml	50	N9306679
200 mg	3 ml	50	N9306680
500 mg	3 ml	30	N9306681
100 mg	6 ml*	30	N9306692
150 mg	6 ml	30	N9306682
200 mg	6 ml	30	N9306683
200 mg	6 ml*	30	N9306693
500 mg	6 ml	30	N9306684
500 mg	15 ml	20	N9306685
500 mg	6 ml*	30	N9306694
1 g	15 ml	20	N9306686
30 mg	15 ml**	50	N9306688
60 mg	15 ml**	50	N9306689
100 mg	15 ml**	50	N9306690
200 mg	15 ml**	50	N9306691
1 g	25 ml	20	N9306687

* Glass columns ** LRC columns

60 µm 96 Well Plates

Media Weight	Volume	Quantity	Part No.
30 mg	2 ml	1	N9306695
50 mg	2 ml	1	N9306696
60 mg	2 ml	1	N9306697

SOLID PHASE EXTRACTION (SPE)

Supra-Poly Columns and 96 Well Plates:

- Contains macro-porous polymers with ultra-pure, pharmaceutical grade spherical particles
- Shorter analysis times, greater load capacity and reduced solvent usage
- Ideal for high throughput assays

Supra-Poly Extreme Capacity 1500 m²/g (XC)

Columns

Media Weight	Volume	Quantity	Part No.
30 mg	1 ml	50	N9306441
50 mg	1 ml	50	N9306500
60 mg	1 ml	50	N9306501
100 mg	1 ml	50	N9306403
60 mg	3 ml	50	N9306502
100 mg	3 ml	50	N9306440
200 mg	3 ml	50	N9306428
200 mg	6 ml	30	N9306635
500 mg	6 ml	30	N9306405
1 g	15 ml	20	N9306503

96 Well Plates

Media Weight	Volume	Quantity	Part No.
30 mg	2 ml	1	N9306557
50 mg	2 ml	1	N9306558
60 mg	2 ml	1	N9306559

Supra-Poly Extra Wide Particle 1200 m²/g (XWP)

Columns

Media Weight	Volume	Quantity	Part No.
30 mg	1 ml	50	N9306504
50 mg	1 ml	50	N9306427
60 mg	1 ml	50	N9306505
100 mg	1 ml	50	N9306506
60 mg	3 ml	50	N9306507
100 mg	3 ml	50	N9306508
200 mg	3 ml	50	N9306509
500 mg	6 ml	30	N9306418
1 g	15 ml	20	N9306510

96 Well Plates

Media Weight	Volume	Quantity	Part No.
30 mg	2 ml	1	N9306560
50 mg	2 ml	1	N9306561
60 mg	2 ml	1	N9306562

Supra-Poly Environmental (AEV)

Columns

Media Weight	Volume	Quantity	Part No.
100 mg	3 ml	50	N9306648

Supra-Poly Hydrophilic (ATH)

Columns

Media Weight	Volume	Quantity	Part No.
100 mg	3 ml	50	N9306646
200 mg	3 ml	50	N9306638
200 mg	6 ml	30	N9306636

Supra-Poly Lipophilic (ATL)

Columns

Media Weight	Volume	Quantity	Part No.
100 mg	3 ml	50	N9306647
200 mg	3 ml	50	N9306639
200 mg	6 ml	30	N9306637

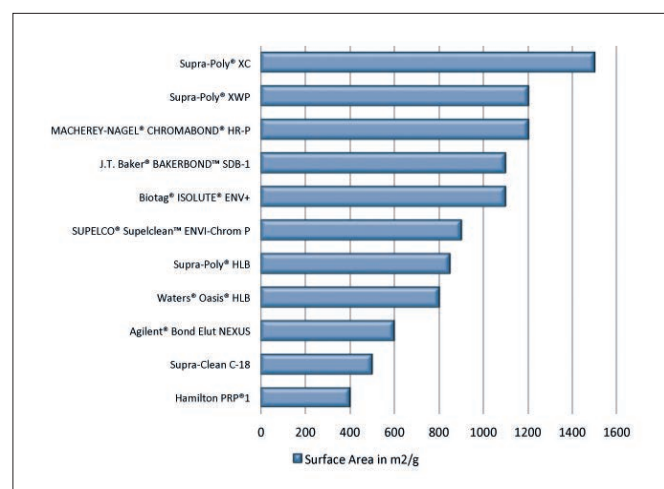

Compared to other industry leading SPE materials, our Extreme Capacity (XC) and Extra Wide Particles (XWP) lead market in surface area. This allows for higher capacities at lower bed weights.

SPE APPLICATION PACKS

Ideal for extraction of known entities from a variety of matrices, our packs are expertly tailored to meet your application needs and are designed to support major EPA methods and applications.

Description	Media Weight	Volume	Quantity	Part No.
Extraction of Basic Drugs from Biological Fluids	200 mg	3 ml	50	N9306605
Extraction of Bisphenol A from Aqueous Matrix	1 g	6 ml	30	N9306613
Extraction of Oil and Grease from Aqueous Matrix-EPA 1664	500 mg	3 ml	50	N9306612
	1 g	6 ml	30	N9306611
Extraction of PAH from Soil and Oil	1.5 g	6 ml	30	N9306609
Extraction of PAH from Soil and Oil (Glass Straight Column)	1.5 g	6 ml	30	N9306610
Extraction of PAH from Water Containing Humic Acids	1.5 g	6 ml	30	N9306608
Extraction of PAH from Water or Soil	4 g	6 ml	30	N9306606
Extraction of PAH from Water or Soil (Glass Straight Column)	4 g	6 ml	30	N9306607
Extraction of PCB from Oil	1 g	6 ml	30	N9306617
	1 g	3 ml	50	N9306616
Extraction of Pesticides and Herbicides from Aqueous Matrix	500 mg	3 ml	50	N9306614
Extraction of Steroids from Biological Fluids	500 mg	6 ml	30	N9306615
Extraction of SVOC from Water-EPA 525	1 g	6 ml	30	N9306618

SPE SELECTION KITS

Enables quick column selection for development of reproducible and repeatable SPE methods.

Description	Media Weight	Volume	Quantity	Part No.
Pre-Concentration of Hydrophobic Compounds from Aqueous Matrix	200 mg	6 ml	50	N9306594
	200 mg	3 ml	50	N9306595
Extraction of Hydrophobic Compounds from Aqueous Matrix	500 mg	6 ml	50	N9306596
	500 mg	3 ml	50	N9306597
Pre-Concentration of Hydrophilic Compounds	500 mg	6 ml	30	N9306598
	500 mg	3 ml	30	N9306599

Description	Media Weight	Volume	Quantity	Part No.
Removal of Polar Compounds from Aqueous and Organic Matrix	500 mg	6 ml	30	N9306600
	500 mg	3 ml	30	N9306601
Extraction of Acidic Basic and Neutral Compounds from Aqueous or Organic Matrix	100 mg	3 ml	50	N9306602
Extraction of Carboxylic Acids and Strong Bases from Aqueous Matrix	500 mg	6 ml	40	N9306603
Extraction of Weak Bases from Aqueous Matrix	500 mg	6 ml	30	N9306604

SPE VACUUM PUMPS, MANIFOLDS AND ACCESSORIES

SPE Vacuum Manifolds accommodate either 12 or 24 cartridges; 1, 3, 6, 15, and 25 mL columns can be used. Manifolds are equipped with a vacuum port to connect a standard laboratory vacuum pump. Vacuum pulls the sample through the stationary phase, metered by the stopcocks, to control the speed of the extraction process and the sample flow. Waste and wash solvents are discarded and analytes are collected in sample tubes below the manifold completing the extraction.

Description	Qty	12 Position Part No.	Qty	24 Position Part No.
Vacuum Manifold	1	N9306619	1	N9306626
Replacement Chamber (Glass)	1	N9306620	1	N9306627
Cover Gasket - 12 Position	1	N9306621	1	N9306628
Stopcocks - 12 Position	12	N9306624	24	N9306631
Needles - Polypropylene	12	N9306622	24	N9306629
Needles - Stainless Steel	12	N9306623	24	N9306630
Drying Attachment	1	N9306625	1	N9306632

Description	Qty	20 L/min 115V	60 L/min 115V	17 L/min 230V	58 L/min 230V
Vacuum Pumps	1	N9308035	N9308063	N9308331	N9308332



AS EASY AS ONE, TWO, SPE



Supra-d QuEChERS Dispersive SPE

Our Supra-d dispersive SPE extraction and clean-up kits have been customized for your specific sample preparation needs. They are designed for both steps of the QuEChERS method and each kit includes pre-prepared products for simplicity and error-free extractions. A certificate of quality is included in each kit, ensuring you have the best for your application. With our extensive line of dispersive SPE kits you'll be sure to find what you're looking for. Add our Supra-d dispersive SPE to your family of sample preparation products.

Features and Benefits:

- High recoveries are achieved for more accurate analyses
- Up to 4 times faster than traditional methods
- Low solvent usage and waste for maximum cost savings

PerkinElmer's Supra-d QuEChERS dispersive SPE turns sample preparation into an easy two-step process by using the QuEChERS method. QuEChERS (Quick, Easy, Cheap, Effective, Rugged, Safe) dispersive SPE, is the number one used sample preparation approach in pesticide residue analysis. It eliminates complex liquid extraction methods and extends the range of recovered pesticides. The QuEChERS procedure is fast and easy, improving lab productivity and resulting in fewer errors.

QUECHERS SIMPLE TWO-STEP PROCEDURE:

Step 1: Extraction

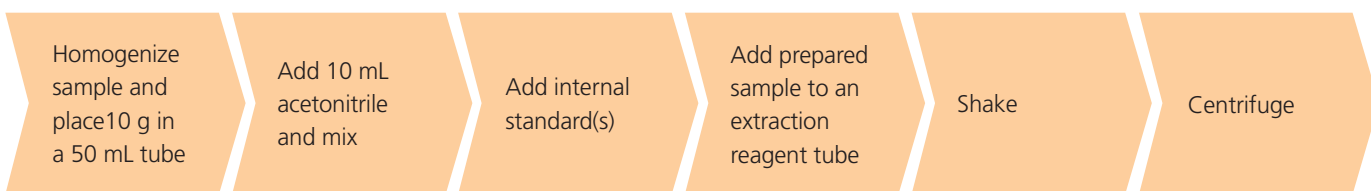

Step 2: Clean-Up



Supra-d QuEChERS For Multiple Pesticide Residue Analysis

PerkinElmer provides the most complete range of products for QuEChERS methodologies, offering all three standard QuEChERS methods: Original QuEChERS method, American AOAC Standard (Official Method 2007.01) QuEChERS method and European Standard (EN 15662) QuEChERS method.



Extraction Kits

Method	Vol.	Qty.	MgSO4	Na Acetate	Na Citrate	Na Citrate Sesquihydrate	NaCl	Part No.	Empty Tube Part No.	Powder Pack Part No.	Powder Pack (500/pk) Part No.
AOAC 2007.01	50 mL	50	6 g	1.5 g				N9306900	N9306935	N9306936	N9306939
EN 15662	50 mL	50	4 g		1 g	0.5 g	1 g	N9306901	N9306935	N9306937	N9306940
Original	50 mL	50	4 g				1 g	N9306902	N9306935	N9306938	N9306941

AOAC 2007.01 Clean-up Kits

Description	Vol.	Qty.	MgSO41	PSA2	C183	PGC4	Part No.
Fruit & Vegetables	2 mL	100	150 mg	50 mg			N9306908
Fruit & Vegetables	15 mL	50	1200 mg	400 mg			N9306909
Fruit & Vegetables with Fats and Waxes	2 mL	100	150 mg	50 mg	50 mg		N9306910
Waxed Fruit & Vegetables	15 mL	50	1200 mg	400 mg	400 mg		N9306911
Pigmented Fruit & Vegetables	15 mL	50	1200 mg	400 mg		400 mg	N9306912
Fruit & Vegetables with Pigments and Fats	2 mL	100	150 mg	50 mg	50 mg	50 mg	N9306913
Fruit & Vegetables with Pigments and Fats	15 mL	50	1200 mg	400 mg	400 mg	400 mg	N9306914

EN 15662 Clean-up Kits

Description	Vol.	Qty.	MgSO41	PSA2	C183	PGC4	Part No.
Fruit & Vegetables	2 mL	100	150 mg	25 mg			N9306920
Fruit & Vegetables	15 mL	50	900 mg	150 mg			N9306921
Fruit & Vegetables with Fats and Waxes	2 mL	100	150 mg	25 mg	25 mg		N9306922
Waxed Fruit & Vegetables	15 mL	50	900 mg	150 mg	150 mg		N9306923
Pigmented Fruit & Vegetables	15 mL	50	900 mg	150 mg		15 mg	N9306924
Pigmented Fruit & Vegetables	2 mL	100	150 mg	25 mg		2.5 mg	N9306925
High Pigmented Fruit & Vegetables	2 mL	100	150 mg	25 mg		7.5 mg	N9306926
High Pigmented Fruit & Vegetables	15 mL	50	900 mg	150 mg		45 mg	N9306927

Clean-up Kit

Description	Method	Vol.	Qty.	MgSO41	PSA2	C183	PGC4	Part No.
Clean-up Kit	Original	15 mL	50	900 mg	300 mg		150 mg	N9306933

¹ MgSO4 removes excess water

² PSA removes sugars, fatty acids, organic acids, and anthocyanine pigments

³ C18 removes nonpolar interferences

⁴ PGC (carbon) removes pigments, sterols, and nonpolar interferences



Disposable Syringes

Designed for use with syringe filters, these disposable, sterile, polypropylene syringes are for general-purpose applications. Packaged in easy-to-open sealed package and they can be autoclaved out of the package.

Description	Pack Size	Part No.
Luer-Lock Tips, 1 mL	100	02542890
Luer-Lock Tips, 3 mL	200	02542891
Luer-Lock Tips, 5 mL	100	02542892
Luer-Lock Tips, 10 mL	100	02542893

Ultramicro Volume Syringes

Recommended for liquid sample injections of less than 5 μL for gas chromatography. Syringes come standard with needle length of 7 cm – optimum for PerkinElmer injectors.

Syringe Capacity	Gauge	O.D.	I.D.	Tip Description	Pack Size	Part No.
0.5 μL	26	0.47	0.1	Bevel	1	N9302231
1.0 μL	23	0.63	0.15	Cone	1	00230177
1.0 μL	261	0.47	0.15	Cone	1	00230111
2.0 μL	23	0.63	0.12	Bevel	1	N9302235
5.0 μL	23	0.63	0.37	Cone	1	00230178

¹ Recommended for PerkinElmer wide-bore capillary adapter

OPTIMIZE SAMPLE THROUGHPUT

The Quality You Need From A Partner You Trust

A broad variety of glass and plastic vials are essential to keeping all of your GC, LC and Headspace instruments running smoothly. Not only are the vial's dimensional qualities important for trouble-free runs, but the physical properties, like being free of contaminants, are equally important in order for your analysis to be accurate.

We're proud to offer you an expanded product selection which includes additional glass and plastic vial types, new caps and matching septa. All tested for the highest quality to meet both your application requirements and are guaranteed for fit and compatibility.

Why Choose PerkinElmer? One Word – Quality

Features and Benefits:

- Vials are made from Type I Borosilicate Glass. This glass meets all USP, JP and EP requirements. This glass is very hard and has a low expansion coefficient even at high temperature
- Vials are stringently tested using camera gauging technology to ensure final product meets all dimensional specifications
- All our vials, caps and septa are fit to perform on PerkinElmer and non-PerkinElmer instruments
- We stock a wide variety of sizes, colors and materials of vials, caps and septa
- All vials are packed in a clean room and those labeled with "LC Clean" include an additional certificate of analysis



How to choose a Vial:

1. Choose a size. Vials come in a variety of sizes.

You measure a vial by looking at the:

- Volume (example is 2 mL)
- Diameter and height (example is 12 mm x 32 mm)
- I.D. of the neck (example is 11 mm)
- Finish (example is a snap top vial)

2. Choose a color.

If your sample is sensitive to light you may want to consider an amber vial.

3. Choose a material.

Vials are available in both glass and polyethylene. If you are analyzing a material that has proteins, you may want to consider using a polyethylene vial.



How to choose a Seal:

1. Choose a septa material.

Temperature, resistance to coring, storage shelf time, the material you are analyzing – all of these variables should be taken into consideration when choosing your septa material. Look to page 119 for an outline on which septa is best for you.

2. Decide between a pre-slit or non-slit septa.

Due to the technique and type of needle they use, pre-slit septa are ideal for LC systems, while non-slit septa are ideal for GC and GC/MS systems.

3. Match the size of the cap/septa with the size of your vial.

Do you need anything else?

We have a wide variety of crimpers, decappers, and vial trays to also make your analysis easier.



Autosampler Vials

PerkinElmer vials are manufactured to specific tolerances that are guaranteed to fit and perform with PerkinElmer and non-PerkinElmer instruments. Our vials are manufactured from Type I Borosilicate Glass, which meets all USP, JP, and EP Pharmacopeia requirements. The glass performs excellent at high temperatures and is chemical resistant to acidic, neutral and alkali solutions. All our vials are packed in a clean environment to ensure you receive contaminant free product every time.

Waste and Wash Vials, Caps and Septa for GC

I.D. Size	Product Description	Part No. 1/Pack	Screw	
			Part No. 100/pack	Part No. 1000/pack
13 mm	Clear Glass Vial - 4 mL (15 x 45 mm)	09923031	N9306247	
	200 µL Vial Insert			N9302681
	Support for Vial Insert			N9302682*
13 mm	Black Cap with PTFE/Silicone (Ultra Low Bleed) Septa		N9304141	N9304142
13 mm	Black Phenolic Cap (no septa)	09923032		
13 mm	Silicone Septa (no cap)		N9302780	

*N9302682 is packaged 500/pack

2 mL Vials (12 x 32 mm):

I.D. Size	Vial Description	Crimp Top		Screw Top		Snap Top	
		Part No. 100/pack	Part No. 1000/pack	Part No. 100/pack	Part No. 1000/pack	Part No. 100/pack	Part No. 1000/pack
8 mm	Clear Glass	N9301069*				N9302945	
9 mm	Clear Glass					N9306201	
	Clear Glass with Write-on Patch and Fill Lines					N9307801	
	Clear Glass with Write-on Patch and Fill Lines (Silanized)					N9304139	
	Clear Polyethelene					N9301733	
	Clear Polyethelene (300 µL capacity)					N9301732	
	Amber Glass					N9306220	
	Amber Glass with Write-on Patch and Fill Lines					N9307802	
	Amber Glass with Write-on Patch and Fill Lines (Silanized)					N9304140	
10 mm	Clear Glass with Write-on Patch and Fill Lines					N9306053	
	Amber Glass with Write-on Patch and Fill Lines					N9306057	
11 mm	Clear Glass	N9301385		N9303418			
	Clear Glass with Write-on Patch and Fill Lines	N9306223		N9306207**			N9307017
	Clear Glass with Write-on Patch and Fill Lines (Silanized)	N9304135		N9304137			
	Amber Glass	N9302680					
	Amber Glass with Write-on Patch and Fill Lines	N9302679		N9306208**		N9307018	
	Amber Glass with Write-on Patch and Fill Lines (Silanized)	N9304136		N9304138			

** N9301069 is packaged 200/pack ; ** Also includes grade levels

Autosampler Fused Vials And Vial Inserts

For easy sampling, try our vials with fused sample inserts. A variety of volumes are available in either clear or amber glass. Polyethylene option available also.



I.D. Size	Capacity	Vial Type	Crimp Top		Screw Top		Snap Top	
			Part No. 100/Pack	Part No. 500/Pack	Part No. 100/Pack	Part No. 1000/Pack	Part No. 100/Pack	Part No. 1000/Pack
8 mm	100 µL	Clear Glass						N9300713
8 mm	100 µL	Amber Glass						N9300714
8 mm	200 µL	Clear Glass		N9302136*				
9 mm	300 µL	Clear Glass						N9300715
9 mm	300 µL	Amber Glass						N9300716
10 mm	300 µL	Clear Glass						N9300717
10 mm	300 µL	Amber Glass						N9300718
11 mm	300 µL	Clear Glass	N9300709		N9300711			
11 mm	300 µL	Amber Glass	N9300710		N9300712			
11 mm	600 µL	Clear Polyethylene		N9302130				

*N9302136 should be used with Glass Vial Support Sleeve (N9307027)

Autosampler Vial Inserts

Our vial inserts are made from the same Type 1, Class A borosilicate glass as our vials and can be used for maximum sample extraction. Vial inserts compatible with the following vials.



Capacity	Dimensions	Qty.	Vial Insert Part No.	Crimp Top		Screw Top		Snap Top	
				Part No. 100/Pack	Part No. 500/Pack	Part No. 100/Pack	Part No. 1000/Pack	Part No. 100/Pack	Part No. 1000/Pack
150 µL	5 x 29 mm Spring (insert only fits 8 mm vial)	100/Pack	N9300705						N9302945
200 µL	5 x 32 mm Flat Bottom (insert only fits 8 mm vial)	100/Pack	N9300706						N9302945
250 µL	6 x 29 mm Spring (this insert fits any 9, 10 or 11 mm vial)	100/Pack	N9300703	N9301385		N9303418	N9307018	N9304139	N9307017
				N9302679		N9304137		N9304140	
				N9302680		N9304138		N9306053	
				N9304135		N9306207		N9306057	
				N9304136		N9306208		N9306201	
				N9306223				N9306220	
				N9306231				N9307801	
400 µL	6 x 31 mm Flat Bottom (this insert fits any 9, 10 or 11 mm vial)	100/Pack	N9300704	N9301385		N9303418	N9307018	N9304139	N9307017
				N9302679		N9304137		N9304140	
				N9302680		N9304138		N9306053	
				N9304135		N9306207		N9306057	
				N9304136		N9306208		N9306201	
				N9306223				N9306220	
				N9306231				N9307801	
				N9307802					

Autosampler Caps And Septa

PerkinElmer offers a variety of caps and septa to fulfill your application needs. Our screw thread vial caps use the revolutionary Inter-Seal®. Using a process that bonds silicone/PTFE and other elastomeric compounds directly into thermoplastic closures eliminates liner fallout, while still providing the excellent resealability and multiple injection capability. No adhesives are used in this process, bonding the cap and septa at the molecular level of plastic and rubber. These septa have a very broad chemical resistance and can be used in many markets including: environmental, diagnostic packaging, pharmaceutical packaging, cosmetic and food packaging.



I.D. Size	Septa Type	Cap Type (Pre-Assembled)	Crimp Top		Screw Top		Snap Top	
			Part No. 100/Pack	Part No. 1000/Pack	Part No. 100/Pack	Part No. 1000/Pack	Part No. 100/Pack	Part No. 1000/Pack
8 mm	PTFE	Aluminum Cap		N9302140				
	PTFE/Red Rubber	Aluminum Cap		03300806				
	PTFE/Silicone	Black Flanged Cap					N9303449	
	PTFE/Silicone (Pre-Slit)	Polyethylene Cap with Slit				N9302141		
9 mm	PTFE/Red Rubber	Blue Cap					N9306200	
	PTFE/Silicone	Blue Cap					N9306360	N9306361
	PTFE/Silicone (ultra-low bleed)	Blue Cap					N9306362	
	PTFE/Silicone (Pre-Slit)	Blue Cap					N9306203	N9306363
	PTFE/Silicone (ultra-low bleed and Pre-Slit)	Blue Cap					N9306364	N9306365
10 mm	PTFE/Red Rubber	Black Cap					N9306206	
	PTFE/Silicone	Black Cap					N9306205	
	PTFE/Silicone (Pre-Slit)	Black Cap					N9306052	
11 mm	PTFE/Red Rubber	Aluminum Cap (Silver)	N9306015*					
	PTFE/Red Rubber	Aluminum Cap (Blue)	N9302686					
	PTFE/Red Rubber	Aluminum Cap (Green)	N9302684					
	PTFE/Red Rubber	Aluminum Cap (Red)	N9302685					
	PTFE/Silicone (white/red)	Aluminum Cap (Silver)	N9307823					
	PTFE/Silicone (white/white)	Aluminum Cap (Silver)	N9306228					
	PTFE/Silicone (white/red)	Clear Plastic Cap			N9303419			
	PTFE/Silicone - pre-slit (white/red)	Clear Plastic Cap			N9303416			
	PTFE/Silicone/PTFE	Aluminum Cap (Silver)	N9306229					
	PTFE/Silicone/PTFE	Gold Magnetic Cap	N6356473					
	PTFE/Silicone/PTFE	Clear Plastic Cap			N9303417			
	Aluminum/PTFE	Aluminum Cap (Silver)		N9302139**				
	Black Viton	Aluminum Cap (Silver)		N9302784				

* Same as part number N9306230 ; **N9302139 is packaged 500/pack

I.D. Size	Septa Type	Cap Type (Un-Assembled)	Crimp Top		Screw Top		Snap Top	
			Part No. 100/Pack	Part No. 1000/Pack	Part No. 12/Pack	Part No. 500/Pack	Part No. 100/Pack	Part No. 1000/Pack
8 mm		PTFE/Buytl					N9303442	
		Phenolic Cap					N9303441	
11 mm		PTFE/Silicone			00091357			
		PTFE/Silicone (Pre-Slit)				N9307021		
		Clear Plastic Cap with Slit				N9307023		
		Clear Plastic Cap with Slit				04978532		

Autosampler Vial, Cap And Septa Convenience Kits

PerkinElmer understands your challenges and offers a variety of kits so that you can easily order and restock your laboratory supplies.



I.D. Size	Septa Type	Cap Type	Vial Type	Screw Top	
				Part No. 100/Pack	Part No. 500/Pack
8 mm	PTFE/Silicone	Black Cap	Clear Glass	N9301945	
9 mm	PTFE/Red Rubber	Blue Cap	Clear Glass	N9300699	
9 mm (certified)	PTFE/Silicone	Blue Cap	Amber Glass	N9300719	
9 mm	PTFE/Silicone	Blue Cap	Clear Glass	N9300700	
9 mm (certified)	PTFE/Silicone	Blue Cap	Clear Glass	N9300707	
9 mm	PTFE/Silicone (Pre-Slit)	Blue Cap	Amber Polyethelene	N9301735	
9 mm (certified)	PTFE/Silicone (Pre-Slit)	Gray Cap	Amber Glass	N9300720	
9 mm	PTFE/Silicone (Pre-Slit)	Blue Cap	Clear Polyethelene	N9301736	
9 mm	PTFE/Silicone (Pre-Slit)	Blue Cap	Clear Polyethelene (300 µL capacity)		N9306080
9 mm (certified)	PTFE/Silicone (Pre-Slit)	Gray Cap	Clear Glass	N9300708	
9 mm	PTFE/Silicone (Pre-Slit)	Blue Cap	Clear Glass	N9300701	
10 mm	PTFE/Silicone (Pre-Slit)	Black Cap	Clear Glass	N9300695	N9300650
10 mm	PTFE/Silicone (Pre-Slit)	Black Cap	Amber Glass	N9300696	

* Same as part number N9306230 ; **N9302139 is packaged 500/pack

I.D. Size	Septa Type	Cap Type	Vial Type	Crimp Top		Snap Top	
				Part No. 100/Pack	Part No. 500/Pack	Part No. 100/Pack	Part No. 1000/Pack
11 mm	PTFE/Red Rubber	Aluminum Cap	Clear Glass	N9300502	N9300503		
11 mm	PTFE/Silicone	Aluminum Cap	Clear Glass	N9300500			
11 mm	PTFE/Silicone	Clear Plastic Cap	Clear Glass			N9300702	
11 mm	PTFE/Silicone (Pre-Slit)	Clear Plastic Cap	Clear Glass			N9300697	
11 mm	PTFE/Silicone/PTFE	Aluminum Cap	Clear Glass	N9300501			
11 mm	PTFE/Silicone/PTFE	Clear Plastic Cap	Clear Glass			N9300698	

Autosampler Vial, Cap And Septa Starter Kits

PerkinElmer understands your challenges and offers a variety of kits so that you can easily evaluate, order and restock your laboratory supplies.



Kits Include:	Part No.	Autosampler Starter Kit Part No. N6120105	GC Educational Consumables Kit with Electronic Crimper Part No. N6500570	GC Educational Consumables Kit with Manual Crimper Part No. N6500571
Manual Hand Crimper with 11 mm Jaws	00090699	1		1
Manual Hand Decapper with 11 mm Jaws	N9301390	1		
Electronic Hand Crimper with 11 mm Jaws	N9304500		1	
2 mL, 11 mm Clear, Crimp Vials	N9301385	100	200	200
2 mL, 11 mm Amber, Crimp Vials	N9302680	100		
11 mm Aluminum Crimp Caps (Silver) with PTFE/Red Rubber Septa	N9306015	100	200	200
11 mm Aluminum Crimp Caps (Green) with PTFE/Red Rubber Septa	N9302684	100		
11 mm Aluminum Crimp Caps (Red) with PTFE/Red Rubber Septa	N9302685	100		
11 mm Aluminum Crimp Caps (Blue) with PTFE/Red Rubber Septa	N9302686	100		
11 mm Silicone Septa (no cap)	N9302780	100		
11 mm Vial Rack - 50 Vial Capacity	N9301303	1	2	1
Syringe 9000 5.0 µL 0.63 mm o.d.	N6101390	1	2	2
Elite 5 Column - 30 M x 0.25 mm x 0.25 µm	N9316076		1	1

Headspace Vials

PerkinElmer offers a variety of GC headspace vials, caps and septa to fulfill your application needs. Our patented vial and cap design incorporates pressure-relief features which guarantee safe operation with the high pressure typically developed during thermostating. Ordinary vials and caps without these safety features may burst. All of our headspace vials have a greater wall thickness and round base which enables them to withstand pressure up to 60 psig. Low-volume sampling can be achieved by using a 6 mL vial and vial adapter. All PerkinElmer headspace vials are manufactured to specific tolerances that are guaranteed for fit and performance.



22 mL Vial Description (23 mm x 75.5 mm)

Description	Crimp Top		Screw Top	
	Part No. 100/Pack	Part No. 1000/Pack	Part No. 100/Pack	Part No. 1000/Pack
Clear Glass with "P" logo (Radius Bottom)		B0104236	N9306075	N9306078
Clear Glass with Write-on Patch and Fill Lines (Radius Bottom)			N9306240	N9306241

20 mL Vial Description (23 mm x 75.5 mm)

Description	Crimp Top		Screw Top	
	Part No. 100/Pack	Part No. 1000/Pack	Part No. 100/Pack	Part No. 1000/Pack
Clear Glass (no logo) (Radius Bottom)		N9306216		
Clear Glass with "P" logo (Radius Bottom)	N6356471*			
Clear Glass with Write-on Patch and Fill Lines (Radius Bottom)	N9303349	N9303348		
	N6356472*	N9303351*	N9306242*	
Clear Glass with Write-on Patch and Fill Lines (Flat Bottom)		N9303352*		

*For use with CTC headspace (actual size = 22.6 x 75.5mm)

10 mL Vial Description (21.75 mm x 46 mm)

Description	Crimp Top		Screw Top	
	Part No. 100/Pack	Part No. 1000/Pack	Part No. 100/Pack	Part No. 1000/Pack
Clear Glass (Radius Bottom)	N6356478		N6356479	

6 mL Vial Description (22 mm x 38 mm)

Description	Crimp Top		Screw Top	
	Part No. 125/Pack	Part No. 1000/Pack	Part No. 100/Pack	Part No. 1000/Pack
Clear Glass (Radius Bottom)	N9302134*			

*Use with Low-Volume Vial Adapter N6120110 in order to fit TurboMatrix 16, TurboMatrix 40, HS 40 (XL), HS 100 or HS 101.

Note: this vial and adaptor will not work with the TurboMatrix 110 headspace sampler. This vial replaces part number B0104235.

Headspace Caps And Septa

Choose the right septa for your analysis. Although a wide variety of septa is available, chemical compatibility and temperature are the most critical to the analysis. Temperature applies not only to the vial, but also to the temperature of the instrument's needle used for pressurization and sample transfer, which is heated to prevent condensation. A needle temperature higher than the vial temperature setting can decompose the septum material. PTFE coated silicone and aluminum-coated silicone offer the highest temperature operating limits. (See Septa Recommended Chart for more details.)



Septa Type	Aluminum Caps (Pre-Assembled)	Crimp Top		Screw Top	
		Part No. 100/Pack	Part No. 1000/Pack	Part No. 100/Pack	Part No. 1000/Pack
Butyl (red)	Aluminum Cap, Star Spring and Septa	N9304143	N1010070		
Butyl (gray)	Aluminum Cap, Star Spring and Septa	N9306269	N9306268		
PTFE/Butyl (red)	Aluminum Cap, Star Spring and Septa	N9304144	B4000025		
PTFE/Butyl (gray)	Aluminum Cap, Star Spring and Septa	N9306265	N9306264		
PTFE/Butyl (gray)	Aluminum Cap		N9302981		
PTFE/Butyl (Pharma Fix Septa)	Aluminum Cap	N9306224			
PTFE/Red Rubber (red)	Aluminum Cap, Star Spring and Septa	N9304147	N9302978		
PTFE/Silicone (white)	Aluminum Cap, Star Spring and Septa	N9304146	B4000022		
PTFE/Silicone (white) Ultra Bleed	Aluminum, Skived Pressure Relief		N9302975		
PTFE/Silicone (white) Ultra Bleed	Aluminum, Skived (non-Pressure Relief)		N9302977		
PTFE/Silicone (natural) Extreme Bleed	Aluminum, Skived (non-Pressure Relief)		N9302976		
Aluminum/Silicone	Aluminum Cap, Star Spring and Septa	N9304145	B4000028		
Septa Type	Steel Magnetic Caps (Pre-Assembled)				
Butyl (gray)	Steel Magnetic Cap	N6356561			
PTFE/Butyl (red)	Steel Magnetic Cap			N9306076	
PTFE/Butyl (gray)	Steel Magnetic Cap	N6356560		N6356477	
PTFE/Butyl (blue)	Bi-Metal Magnetic Cap	N6356565			
PTFE/Butyl (Pharma Fix Septa)	Steel Magnetic Cap	N6356562			
PTFE/Silicone (red)	Steel Magnetic Cap			N6356474	
PTFE/Silicone (white)	Steel Magnetic Cap			N9306077	
PTFE/Silicone (natural)	Steel Magnetic Cap	N6356558			
PTFE/Silicone (blue)	Steel Magnetic Cap	N6356559		N6356475	
PTFE/Silicone (blue) SPME Liner	Steel Magnetic Cap	N6356564			
PTFE/Silicone (blue)	Bi-Metal Magnetic Cap	N6356566			
Aluminum/Silicone	Steel Magnetic Cap	N6356563			
Septa Type	Aluminum Caps (Un-Assembled)				
Butyl (red)	Aluminum Cap, Star Spring and Septa	B0159356	B0159357		
Butyl (gray)	Aluminum Cap, Star Spring and Septa	N9306270	N9306271		
Butyl (gray) Stopper	Aluminum Cap (Ridged)		N9303350		
Butyl (gray) Stopper	Aluminum Cap		B0110728		
Butyl (gray) Stopper		B0038137			
PTFE/Butyl (red)	Aluminum Cap, Star Spring and Septa	B0104239	B0104240		
PTFE/Butyl (gray)	Aluminum Cap, Star Spring and Septa	N9306266	N9306267		
PTFE/Red Rubber (red)	Aluminum Cap, Star Spring and Septa	N9302979	N9302980		
PTFE/Silicone (white)	Aluminum Cap, Star Spring and Septa	B0104241	B0104242		
Aluminum/Silicone	Aluminum Cap, Star Spring and Septa	B0104243	B0104244		
	Aluminum Cap	B0099814	N9302969		

Cap and Septa Compatibility

Temperature Range	Aluminum/Silicone Up to 220 °C	PTFE/Silicone up to 210 °C	PTFE/Red Rubber up to 160 °C	PTFE/Butyl (Red or Gray) up to 130 °C	Red or Gray Butyl up to 130 °C
Use for multiple injections?	No	Yes	Yes	No	No
Price per 1000	Most Expensive	Expensive	Economical	Economical	Very Economical
Resistance to coring	Good	Excellent	Good	Low	Low
Recommended for storage	Yes	Yes	Yes	No	No

Headspace Vial, Cap And Septa Convenience Kits

PerkinElmer understands your challenges and offers a variety of kits so that you can easily order and restock your laboratory supplies.



Septa Type	Cap Type	Vial Type	Crimp Top	
			Part No. 100/Pack	Part No. 500/Pack
Butyl (red)	Aluminum Cap, Star Spring and Septa	20 mL Crimp Top Clear Glass with Write on Patch and Fill Lines	N9303990	
Butyl (gray)	Aluminum Cap, Star Spring and Septa	20 mL Crimp Top Clear Glass with Write on Patch and Fill Lines	N9306269	
PTFE/Butyl (red)	Aluminum Cap, Star Spring and Septa	20 mL Crimp Top Clear Glass with Write on Patch and Fill Lines	N9303991	
PTFE/Butyl (gray)	Aluminum Cap, Star Spring and Septa	20 mL Crimp Top Clear Glass with Write on Patch and Fill Lines	N9306265	
PTFE/Silicone (natural)	Aluminum, Skived Pressure Relief (extreme bleed)	20 mL Crimp Top Clear Glass with Write-on Patch and Fill Lines (Flat Bottom)		N9300901
PTFE/Silicone (white)	Aluminum, Skived Pressure Relief (ultra bleed)	20 mL Crimp Top Clear Glass with Write-on Patch and Fill Lines (Flat Bottom)		N9300902
PTFE/Silicone (white)	Aluminum, Skived (ultra bleed)	20 mL Clear Glass with Write-on Patch and Fill Lines (Flat Bottom)		N9300903
PTFE/Silicone (white)	Aluminum Cap, Star Spring and Septa	20 mL Crimp Top Clear Glass with Write on Patch and Fill Lines	N9303992	
Aluminum/Silicone	Aluminum Cap, Star Spring and Septa	20 mL Crimp Top Clear Glass with Write on Patch and Fill Lines	N9303993	

Septa Type	Cap Type	Vial Type	Screw Top
			Part No. 100/Pack
PTFE/Silicone	Open Top Gray Polypropylene Screw Cap	40 mL Screw Top Clear Glass (24 mm x 98 mm)	N6352030
PTFE/Silicone	Open Top Gray Polypropylene Screw Cap	40 mL Screw Top Amber Glass (24 mm x 98 mm)	N6352031
PTFE/Silicone			N6352032
	Open Top Gray Polypropylene Screw Cap		N6352033*



*N6352033 is only available in 72/pack

Headspace Starter Kits

We offer a variety of headspace consumables so you can evaluate different types of septa and vials for your sampling requirements.



Kits Include:	Part No.	Headspace Starter Kit 500	Headspace Starter Kit 100	Headspace Mini Starter Kit	Headspace Mini Starter Kit 1000
		Part No. B0505601	Part No. N6710195	Part No. N6710197	Part No. N6710198
20 mm Hand Crimper	N9302785	1	1	1	1*
20 mL Clear Glass Crimp Top Vials	N9306079	500	500	100	1000
PTFE/Butyl (red) Septa with Pre-Assembled Aluminum Crimp Caps	B0104239	100	100	100	
PTFE/Silicone (white) Septa with Pre-Assembled Aluminum Crimp Caps	B0104241	100	100	100	1000
Aluminum/Silicone Septa with Pre-Assembled Aluminum Crimp Caps	B0104243	100	100	100	
20 mL Clear Glass Screw Top Vials	N9306075	500	100	100	
PTFE/Butyl (red) Septa with Steel Magnetic Screw Caps	N9306076	100	100	100	
PTFE/Silicone (white) Septa with Steel Magnetic Screw Caps	N9306077	100	100	100	
Needle Seal Assemblies	B0500833	2	2	2	
O-Rings	B0198110	10	10	10	
Pressure Gauge with Needle for Vials	B0501377	1	1	1	
Static Headspace GC Theory and Practice™ book by B. Kolb and L.S. Ettre	N1011210	1	1		

* This kit includes an Ergonomic Hand Crimper

ELECTRONIC HANDHELD AND BENCHTOP

Crimping Tools And Vial Accessories

Whatever your need may be, PerkinElmer offers a wide range of crimping tools for your convenience. Our universal voltage, precision control, power crimpers with adjustable settings are designed to deliver hundreds of crimps on a single battery charge.



Headspace Crimper and Decapper Tools

Description	Quantity	Part No.
Benchtop Crimper	1	N6621006
Benchtop Crimper Jaws - 20 mm	1	N6621009
Electronic Hand Crimper - 20 mm	1	N9304501
Electronic Hand Decapper - 20 mm	1	N9304503
Manual Hand Crimper - 20 mm	1	N9302785
Manual Hand Crimper (Ergonomic) - 20 mm	1	N6621037
Manual Hand Decapper - 20 mm	1	N9301270
Manual Hand Decapper (Ergonomic) - 20 mm	1	N6621038



Autosampler Crimper and Decapper Tools

Description	Quantity	Part No.
Benchtop Crimper	1	N6621006
Benchtop Crimper Jaws - 11 mm	1	N6621008
Electronic Hand Crimper - 11 mm	1	N9304500
Electronic Hand Decapper - 11 mm	1	N9304502
Manual Hand Crimper - 8 mm	1	N9306127
Manual Hand Crimper - 11 mm	1	00090699
Manual Hand Crimper (Ergonomic) - 11 mm	1	N6621035
Manual Hand Decapper - 11 mm	1	N9301390
Manual Hand Decapper (Ergonomic) - 11mm	1	N6621036



Vial Racks

Description	Quantity	Part No.
11 mm Vial Rack - 50 Vial Capacity	1	N9301303
20 mm Vial Rack - 36 Vial Capacity	1	N9301304

VERIFY QUANTIFY SIMPLIFY

The Flexar SQ 300 MS

Ideal for a variety of analyses, this single quadrupole detector brings the unsurpassed sample insight of mass spectrometry to liquid chromatography applications. The Flexar SQ 300 MS™ is an integral part of the powerful and flexible Flexar LC product line. It features a revolutionary interchangeable probe and unique multi-stage ion path for exceptional sensitivity.

Measuring has never been easier with the Flexar SQ 300 MS. It provides the simplest route to exactly the information you need — quickly. As part of the Flexar LC platform, labs can expect exceptional chromatography coupled with an innovative rugged single quadrupole mass spectrometer that offers:

- Exceptional front-end chromatographic separation capabilities
- Flexible, modular components to suit any LC/MS analytical need
- The widest selection of operating pressures to address throughput needs

The Flexar SQ 300 MS has three ion source options that allow you to specifically address your analytical needs:

- Ultraspray™ Electro spray Interface (ESI)
- Dual-probe Ultraspray2™ (ESI)
- Atmospheric Pressure Chemical ionization (APCI)

Powered by the PerkinElmer Chromera® software, instrument control and data acquisition are faster and easier than ever.

Calibration Vials and Caps

Description	Quantity	Part No.
50ML Polypropylene Calibration Vial	Each	MZ108391-5001
50ML Polypropylene Calibration Vial Cap	Each	MZ108391-5002



Tuning and Calibration Reagents

Description	Size	Part No.
ESI Tuning and Calibration Reagent (Required for AxION TOF)	100 mL	ZG2421A
ESI Tuning and Calibration Reagent - low concentration (For AxION TOF)	100 mL	ZG196985000
APCI Tuning and Calibration Reagent (Required for APCI or DSA Sources with AxION TOF)	100 mL	MZ331300
APCI Tuning and Calibration Reagent - low concentration (For APCI, not recommended for DSA)	100 mL	MZ331301

Calibration Solutions

Description	Part No.
Calibration Mix LC/MS (+) ION Mix	MZ301198
Calibration Mix LC/MS (-) ION Mix	MZ301199

Test Kits

Description	Part No.
SQ300 Installation Performance Test Kit	MZ300061
SQ300 Customer Performance Test Kit	MZ300085
Caffeine Quantitative Test Kit	MZ300095
SQ300 ESI Positive and Negative Test Kit	MZ300096

Spare Syringes and Needles (for Syringe Pump)

Description	Part No.
Hamilton 500uL Gas Tight Syringe (No Needle)	09220120
Hamilton Replacement 6-pack of Needles	09220122

AxION Separation Probes

The innovative separation probes and holders facilitate chromatography directly at the ionization source. This minimizes dead volume effects in the system for superior signal-to-noise ratios, enhanced sensitivity and narrower peaks. Compatible with LC/MS systems using Flexar SQ300 or AxION 2 TOF MS.

Description	Quantity	Part No.
Probe Column - 2.1 mm x 5 mm	Each	N9304550
Probe Column - 2.1 mm x 10 mm	Each	N9304551
Probe Column - 2.1 mm x 50 mm	Each	N9304554
Probe Column - 2.1 mm x 100 mm	Each	N9304556
Probe Holder - 5 mm	Each	N9304552
Probe Holder - 10 mm	Each	N9304553
Probe Holder - 50 mm	Each	N9304555
Probe Holder - 100 mm	Each	N9304557

Spare Probe Assemblies / Dielectric Capillary

Description	Part No.
ESI Probe and Capillary Entrance Cone Kit	MZ300503
Capillary Entrance Cone	MZ105094
ESI Probe	MZ109197
Dielectric Capillary	MZ105057-60180
Quartz Tube for APCI	MZ109004
Corona Needle for APCI	MZ301193
ESI needle (tube) 0.006 "	MZ101903-17

LC/MS Filtration System

High Capacity Hydrocarbon Trap

- Contains 750 cc of preconditioned activated charcoal.
- Stainless steel body. ¼" brass compression fittings with ferrules for installation.
- Maximum pressure 200 psi.
- Recommended flow rate up to 2 L per minute.
- Will remove hydrocarbon impurities (50 ppm or less) from inert gases, nitrogen and hydrogen at room temperature to low ppb range.
- Capacity of 67 g of hydrocarbons C5 and heavier.
- 10 µ stainless steel porous frits protect gas stream from particulates.
- Individually helium leak tested. Shipped filled with helium.



Description	Part No.
LC/MS Filtration System	N9301208

Custom Benches

Description	Part No.
120V Bench with Ventilated, Sound Dampened Pump Enclosure	N2911197
120V Bench with Monitor/Keyboard Arm, Side Shelf and Ventilated, Sound Dampened Pump Enclosure	N2911196
230V Bench with Ventilated, Sound Dampened Pump Enclosure	N2911199
230V Bench with Monitor/Keyboard Arm, Side Shelf and Ventilated, Sound Dampened Pump Enclosure	N2911198
Roughing Pump Box with Acoustically Insulated Pump Enclosure	N8141230
Uninterrupted Power Supply (UPS)	N0777511

LC/MS Consumables and Accessories

Description	Pkg	Part No.
Certified LC Clean™ Non-Slit, Screw Top Cap/Vial Convenience Kit (Clear)	100	N9300707
Certified LC Clean™ Pre-Slit, Screw Top Cap/Vial Convenience Kit (Clear)	100	N9300708
Certified LC Clean™ Non-Slit, Screw Top Cap/Vial Convenience Kit (Amber)	100	N9300719
Certified LC Clean™ Pre-Slit, Screw Top Cap/Vial Convenience Kit (Amber)	100	N9300720
96-well 7 mm Pre-slit Silicone Plate Mat/Seal	10	N9302555
96-well 'Deep-well' Microtiter Polypropylene Plate	5	N9302560
96-well Microtiter Polypropylene Plate	1	N9302562
Barcode labels (25 sheets; 270 labels/sheet)	25	09410105
Edwards Rough Pump Oil (1 liter). Note: pump oil change requires 2 liters	1	MZ109017

LC/MS Caps

Description	Part No.
100 pg/µl Caffeine Standard	MZ301236
Sampling Screen	MZ305382
Capillary Sample Tubes (100/pkg)	MZ305385

INNOVATION TO THE CORE

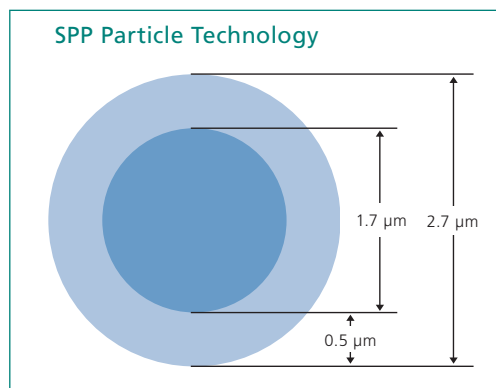

Smaller in size and innovative in design, superficially porous particles are made by fusing a porous silica layer to a solid inner core.

Brownlee SPP HPLC and UHPLC Column Solutions

Say goodbye to the limitations of traditional columns and experience greater speed, lasting durability and better results from your Liquid Chromatography instrument.

Brownlee Superficially Porous Particle (SPP) columns produce sharper peaks and faster separation results. These results are possible due to their breakthrough particle design and size. Brownlee SPP columns use 2.7 μm particles comprised of a thin outer shell of high-quality porous silica fused to a solid inner core. This advanced design allows for a shorter diffusion path, reducing the time solute molecules spend inside the particles while passing through the stationary phase.

Get the speed and efficiency of sub-2 mm UHPLC columns at ~ 50% the backpressure with Brownlee 2.7 μm SPP columns.

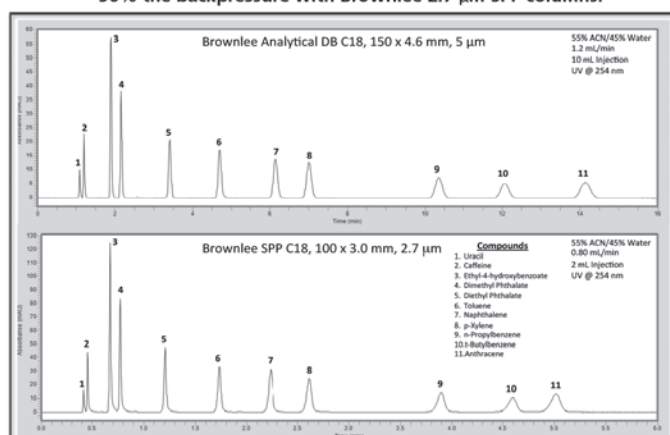

Brownlee SPP Phases and Applications

UHPLC Phases*	PoreSize (Å)	Coverage (μmol/m ²)	pH Range	Temp Limit (°C)	Applications	Chromatographic Properties
C18	90	3.5	2 to 9	60	General Purpose Octadecyl phase for reversed phase separations.	A high-purity column that exhibits excellent peak shape for a wide range of compounds.
C8	90	3.7	2 to 9	60	General Purpose Octyl phase for reversed phase separations when less retention than a C18 is desired.	High purity reversed phase packing that exhibits excellent peak shape for a wide range of compounds.
HILIC**	90	N/A	2 to 8	60	General purpose bare silica column for normal phase and HILIC applications.	High purity silica substrate.
Peptide ES-C18**	160	2.0	1 to 8	90	Sterically protected ligand (isobutyl - side chains), results in an extra stable bonded phase at low pH where most peptide separations are performed.	The 160 Angstrom pore size was specially chosen for the molecular weight range of peptides. The ligand was chosen due to its sterically protected bonding technology that inhibits acid hydrolysis of the siloxane bonds, even under extremes of high temperature and low pH.
PPF (pentafluoro-phenylpropyl)	90	3.6	2 to 8	60	Highly retentive and selective for protonated basic analytes and molecules containing aromatic moieties.	End-capped pentafluorophenyl with a propyl spacer.
PhenylHexyl	90	3.0	2 to 9	60	Alternative selectivity to alkyl bonded phases, recommended for aromatic groups. Compatible with highly aqueous mobile phases to facilitate the retention and separation of polar compounds.	Base-deactivated for good peak shapes when separating basic compounds. Hexyl spacer provides optimal flexibility for phenyl ring to facilitate π-π interactions with solutes.
RP-Amide	90	3.0	2 to 9	60	Excellent phase for significantly increasing the retention and selectivity of acids, for symmetrical peak shapes of bases, zwitterions and other polar compounds.	Base-deactivated phase with a polar group within the alkyl bonded phase. Provides unique selectivity and a high level of base deactivation while reducing or eliminating the need for mobile phase additives.

* Maximum pressure 9,000 p.s.i. for all columns. All particle sizes are 2.7 μm.

**Not end-capped. All others end-capped.

PERFORMANCE FOR EVERY PHASE

Brownlee SPP Columns



Phase	Length (mm)	2.1 mm i.d. Part No.	3.0 mm i.d. Part No.	4.6 mm i.d. Part No.
C18	20	N9308400	N9308406	N9308412
	30	N9308401	N9308407	N9308413
	50	N9308402	N9308408	N9308414
	75	N9308403	N9308409	N9308415
	100	N9308404	N9308410	N9308416
	150	N9308405	N9308411	N9308417
Peptide ES-C18	30	N9308450	N9308455	N9308460
	50	N9308451	N9308456	N9308461
	75	N9308452	N9308457	N9308462
	100	N9308453	N9308458	N9308463
	150	N9308454	N9308459	N9308464
C8	20	N9308418		N9308429
	30	N9308419	N9308424	N9308430
	50	N9308420	N9308425	N9308431
	75	N9308421	N9308426	N9308432
	100	N9308422	N9308427	N9308433
	150	N9308423	N9308428	N9308434
PFP	20	N9308465		
	30	N9308466	N9308471	N9308476
	50	N9308467	N9308472	N9308477
	75	N9308468	N9308473	N9308478
	100	N9308469	N9308474	N9308479
	150	N9308470	N9308475	N9308480
Phenyl Hexyl	20	N9308481		
	30	N9308482	N9308487	N9308492
	50	N9308483	N9308488	N9308493
	75	N9308484	N9308489	N9308494
	100	N9308485	N9308490	N9308495
	150	N9308486	N9308491	N9308496
RP-Amide	20	N9308497		
	30	N9308498	N9308503	N9308508
	50	N9308499	N9308504	N9308509
	75	N9308500	N9308505	N9308510
	100	N9308501	N9308506	N9308511
	150	N9308502	N9308507	N9308512
HILIC	30	N9308435	N9308424	N9308430
	50	N9308420	N9308425	N9308431
	75	N9308421	N9308426	N9308432
	100	N9308422	N9308427	N9308433
	150	N9308423	N9308428	N9308434

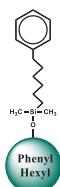
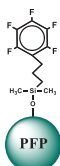
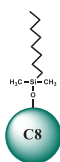

SPP Guard Columns (3 Packs)*

Phase	Length (mm)	2.1 mm i.d. Part No.	3.0 mm i.d. Part No.	4.6 mm i.d. Part No.
C18	5	N9308513	N9308514	N9308515
Peptide ES-C18	5	N9308528	N9308529	N9308530
C8	5	N9308522	N9308523	N9308524
PFP	5	N9308531	N9308532	N9308533
Phenyl Hexyl	5	N9308519	N9308520	N9308521
RP-Amide	5	N9308516	N9308517	N9308518
HILIC	5	N9308525	N9308526	N9308527
SPP Guard Column Holder		N9308534	N9308534	N9308534

* Maximum pressure 9,000 p.s.i. for all columns. All particle sizes are 2.7 µm.



THE TECHNOLOGY YOU NEED TO SEPARATE FROM THE PACK

Brownlee Instrument Optimizaton Kits

Brownlee SPP columns can be used to enhance the performance of virtually any PerkinElmer, Agilent®, or other manufacturer's HPLC or UHPLC system. Our SPP columns deliver resolution and speed similar to sub-2 µm UHPLC columns, but generate only 40% to 50% of the backpressure. By combining high efficiency and lower backpressure, Brownlee SPP columns make it possible to get "UHPLC-like" performance from your HPLC system.

PerkinElmer has created, tested and made the following PerkinElmer and Agilent® optimization kits available. Our OneSource Service Engineers are certified on all leading manufacturer instruments and can help optimize your instrument's performance.

PerkinElmer Optimization Kits

Description	Part No.
Series 200 LC or Flexar UHPLC systems with UV/Vis detector	N2920191
Series 200 LC or Flexar UHPLC systems with PDA detector	N2920193

Agilent® Optimization Kits

Description	Part No.
Extra column volume (ECV) - STD Autosampler and Variable Wavelength Detector (VWD) Optimization Kit	ZECVSTDVWD
ECV - STD Well Plate Autosampler and Diode Array Detector/Multiple Wavelength Detector (DAD/MWD)	ZECVSTDWPDADMWD
ECV - STD Autosampler sand DAD/MWD	ZECVSTDADMWD
ECV - STD Well Plate Autosampler and VWD	ZECVSTDWVWD
Ultra Low ECV - STD Autosampler and VWD	ZULECVSTDVWD
Ultra Low ECV - STD Well Plate Autosampler and DAD/MWD	ZULECVSTDWPDADMWD
Ultra Low ECV - STD Autosampler and DAD/MWD	ZULECVSTDADMWD
Ultra Low ECV - STD Well Plate Autosampler and VWD	ZULECVSTDWVWD



Benefits:

- Generate UHPLC like separations on your standard HPLC system
- Achieve ultra fast performance and efficiency on your UHPLC system
- Run samples in a fraction of the time
- Experience significant savings through faster method development, column longevity and use of less mobile phase solvent



SELECT THE BEST COLUMN

Which Column Do I Need?

Having the right stationary phase for your separation is the first step in selecting the appropriate column. This should be based on sample solubility and on chemical differences among the sample compounds.

Depending on the mode of separation you will use, PerkinElmer has the right column for you. In reversed-phase separations, the mobile phase is more polar than the stationary phase. Sample hydrophobicity also is a major determinant of the separation mode. In reversed-phase separations, the mobile phase is more polar than the stationary phase, which is traditionally a straight alkyl chain, most often C18.

The majority of HPLC analyses are performed in reversed-phase mode, due to the fact that the analytes of interest can be dissolved in water, or mixtures of water and a polar organic solvent such as methanol or acetonitrile.

In normal phase separations, the mobile phase is less polar than the stationary phase. Cyano phases are commonly used in either reversed-phase or normal-phase mode. A stationary phase incorporating both polar and nonpolar functionality can be used in either reversed-phase or normal-phase mode.

Modes of Separation

Reversed-Phase Chromatography (RPC) is the most popular HPLC mode and is used in 60% – 80% of all applications. In RPC, hydrophobic groups (C18, C8, or C4) bonded to a silica support are used together with a mobile phase of water and organic solvent (e.g. methanol, acetonitrile).

Polar Phase (Normal Phase) Chromatography (NPC) uses a polar stationary phase (unbonded silica, bonded amino or cyano group) together with a non-polar mobile phase (e.g., hexane). NPC is useful for functional group analysis, isomeric separations, purification of organics, and sample cleanup.

Ion-Exchange Chromatography (IEC) utilizes bonded ionic groups to separate ionic analytes. Retention is based on the affinity of various analyte ions for the stationary phase and various mobile phase parameters (e.g., pH, ionic strength).

Column Hardware

Brownlee Conventional Columns

Brownlee Columns provide a wide range of options for HPLC analysis. Our conventional columns (non-cartridge) use standard compression end fittings compatible with all HPLC instrumentation. These columns do not require MPLC holders.

Features and Benefits

- End fittings compatible with HPLC systems from any vendor
- Use with NewGuard system (line connection) for even longer column life
- Each column is individually tested
- ISO-9001 certified process ensures the highest quality



Conventional columns do not require MPLC holders



Brownlee MPLC cartridges and holders



NewGuard cartridge coupled directly to 220 mm cartridge column

Brownlee Conventional Columns

Brownlee analytical and semi-prep scale cartridge columns are available in several phases, lengths and diameters. The Brownlee cartridge system holders are designed with finger-tight assembly for simplicity and the standard 1/16" o.d. capillary tubing fittings allow them to be used in virtually any manufacturers HPLC systems. Additionally the cartridge holder system can incorporate guard columns that are directly coupled to the analytical column for a zero dead volume connection. Specific column holders are required different column lengths but the analytical holders will work with both the 4.6 mm and 2.1 mm diameter cartridges. Column hardware, especially the end fittings, is a significant percentage of the cost in HPLC columns. With Brownlee cartridge holders the end fittings are reusable so the column cartridges are less expensive than conventional columns resulting in lower cost operation over the long term. The pressure rating on Brownlee cartridge holders are 7000 psi for silica based columns.

Features and Benefits

- **Quality:** Columns are manufactured under stringent ISO-9001 certified quality control standards. Individual test chromatograms are included with each cartridge > 30 mm length
- **Flexible:** Same reusable holder for 4.6 mm and 2.1 mm i.d. cartridges. Compatible with all HPLC instruments
- **Economical:** Cartridges are less expensive than conventional columns
- **Experience:** Over 35 years of manufacturing experience since Bob Brownlee introduced the first finger-tight cartridge system in 1977

Brownlee Conventional Column Options:

Brownlee Analytical

This is PerkinElmer's all-purpose HPLC column line for conventional as well as high speed LC separations. The (110 Å) silica is equivalent to the Hypersil. Columns are available in 3 or 5 μ and lengths ranging from 30 – 250mm, in 2.1 and 4.6 i.d. The Brownlee Analytical family includes Amino, Biphenyl, C18, C8, Cyano, Phenyl, Silica, and PAH phases.

Brownlee Analytical DB and HRes

These columns allow analysis of a range of compounds from small molecules to short peptides while the base deactivation makes these columns appropriate for the analysis of acidic to basic compounds. These (140 Å) silica columns are excellent replacements for Hypersil® BDS columns. Columns are available in 1.9, 3 or 5 μ .

Brownlee Aquapore® and Bio

This is a wide-pore (300 Å, 7, and 20 μ m), silica-based support suitable for the separation of large biomolecules such as peptides and proteins. Columns are available in 5 μ and lengths ranging from 30 – 250mm, in 2.1 and 4.6 i.d. in C8 and C18 phases.

Brownlee CHOICE™

This line of columns is made of (60 Å) silica which results in large surface area, high carbon loads, and high retention compounds. Columns are available in 3 or 5 μ and lengths ranging from 30 – 250 mm, in 2.1 and 4.6 i.d. The Brownlee CHOICE family includes the Basix, C18, Organic Acids, and PFP Propyl phases.

Brownlee Spheri-5®

This is a small-pore (80 Å, 5 μ m), silica based sorbent for separating small molecules. Both monofunctional (comb-pre) and polyfunctional (polymerized loop-type) C8 and C18 sorbents available.

Brownlee Validated™

These columns are made on high-purity, Type B silica with inherent low silanophilic activity. It exhibits excellent peak shape for a wide range of compounds while also having a wide number of phases. The Brownlee Validated columns are the best choice for pharmaceutical applications that deal with a lot of basic or multi-functional compounds. Columns are available in 3 or 5 μ and lengths ranging from 30 – 250mm, in 2.1 and 4.6 i.d., and include Amino, C18, C8, Carbamate, Cyano, IBD (intrinsically base-deactivated), PFP (pentafluorophenyl) and phenyl phases.

Guard Columns and Cartridges

To protect your column investment, we offer a complete line of guard columns in our direct connect guard cartridges. These can be attached to any column offered above. You can easily select the phase type to the appropriate guard column packing to ensure a correct silica match.

Brownlee Sorbents

Brownlee offers a wide selection of sorbents based on both silica and polymer supports.

Aquapore® is a wide-pore (300 Å, 7, and 20 μ m), silica-based support suitable for the separation of large biopolymers.

Spheri-5® is a small-pore (80 Å, 5 μ m), silica-based sorbent for separating small molecules. Both monofunctional (comb-type) and polyfunctional (polymerized loop-type) C8 and C18 sorbents are available.

Polypore® is a polymer-based (microporous, 10 μ m) sorbent for the analysis of organic acid and sugars.

Validated™ is a small-pore (100 Å, 5 μ m) silica-based C18 sorbent for small molecules, specifically for consistent pharmaceutical assays.

Pecosphere™ is a small-pore (80 Å, 3, 5, and 10 μ m) silica-based sorbent for HPLC of small molecules.

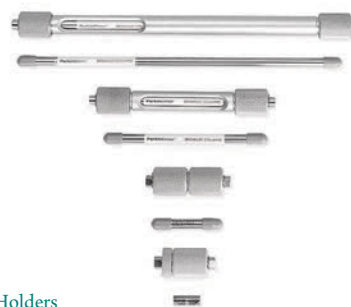

Brownlee
Columns and Holders

Reduced Activity is a small-pore, base-deactivated (100 Å, 3, and 5 μ m) silica-based, reversed-phase sorbent (C18 or C8) developed for HPLC of basic analytes and pharmaceuticals.

CHOICE™ is a small-pore, base-deactivated (100 Å, 3 μ m C18) silica-based, reversed-phase sorbent (C18) developed for LC/MS separations.

Brownlee Analytical Columns

Brownlee Analytical columns are built on 110 Å pore size Type A silica in 3 µm and 5 µm particle sizes that is equivalent to the classic Hypersil® silica. These columns provide excellent peak shape for acidic and neutral analytes but are generally not recommended for basic analytes. They are available in column lengths from 30 – 250 mm in 2.1 and 4.6 mm i.d. The Brownlee Analytical family includes classic phases like C18, C8, Phenyl, Cyano, Amino and bare Silica (HILIC) plus uniquely selective phases like Biphenyl and PAH.

Features and Benefits

- Type A, 110 Å pore size silica equivalent to classic Hypersil® silica
- Good choice when analyzing neutral and acidic analytes
- Available in classic phases and unique phases like biphenyl and PAH

Material Characteristics

Phase*	Particle Sizes (µm)	Pore Size (Å)	Carbon Load	End Capping	pH Stability	Temp. Limit	USP Code
C18	3.0, 5.0	110	13%	Yes	2.5 – 7.5	80 °C	L1
C8	5.0	110	7%	Yes	2.5 – 7.5	80 °C	L7
Cyano	5.0	110	4%	Yes	2.5 – 7.5	80 °C	L10
Amino	3.0, 5.0	110	2%	No	2.5 – 7.5	80 °C	L8
Phenyl	5.0	110	6%	Yes	2.5 – 7.5	80 °C	L11
Biphenyl	5.0	110	*	Yes	2.5 – 7.5	80 °C	L11
PAH	4.0	110	*	Yes	2.5 – 7.5	80 °C	
Silica	5.0	110		No	2.5 – 7.5	80 °C	L3

* Proprietary

Brownlee Analytical C18

Excellent choice for a general purpose C18 column with intermediate carbon loading and surface area. These columns provide reliable performance and excellent peak symmetry for a broad range of acidic and neutral hydrophobic compounds.

Particle Size (µm)	Length (mm)	ID (mm)	Part No.
3.0	30	4.6	N9303509
3.0	50	4.6	N9303510
3.0	100	4.6	N9303507
3.0	150	4.6	N9303508
5.0	100	4.0	N9303511
5.0	100	4.6	N9303512
5.0	150	4.6	N9303513
5.0	250	4.6	N9303514

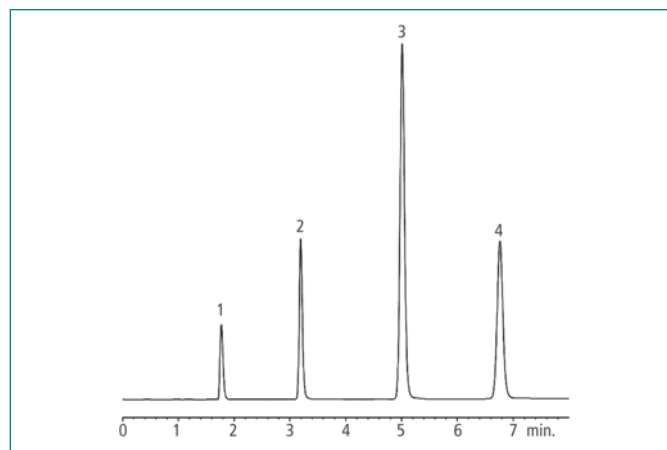

Column: Brownlee Analytical C18
Dimensions: 150 x 4.6 mm
Part Number: N9303508
Mobile Phase: 20:80, Water:Methanol
Flow Rate: 1.0 mL/min
Detector: UV @ 254 nm
Peak List:

1. Uracil
2. Benzene
3. Naphthalene
4. Biphenyl

CONVENTIONAL COLUMNS

Brownlee Analytical C8

Excellent choice for a general purpose C18 column with intermediate carbon loading and surface area. These columns provide reliable performance and excellent peak symmetry for a broad range of acidic and neutral hydrophobic compounds.

Particle Size (µm)	Length (mm)	ID (mm)	Part No.
5.0	30	4.6	N9303521
5.0	100	4.6	N9303515
5.0	150	4.0	N9303516
5.0	150	4.6	N9303517
5.0	200	4.6	N9303518
5.0	250	4.0	N9303519
5.0	250	4.6	N9303520

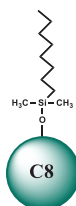

Brownlee Analytical Cyano

The Analytical Cyano is a traditional monomeric cyanopropylsilane stationary phase that can be used in normal-phase, reverse-phase and HILIC modes. Use mobile phase pH between 5 and 7 for the best performance in reverse-phase mode. The cyano phase is often considered to have orthogonal selectivity to C8 & C18 that can be used for confirmatory analysis. Suitable for analysis of a wide range of compounds from acidic to slightly basic and is an excellent choice for analysis of protonated bases.

Particle Size (µm)	Length (mm)	ID (mm)	Part No.
5.0	150	4.6	N9303522
5.0	200	4.6	N9303523

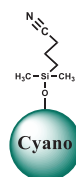

Brownlee Analytical Amino

The Analytical Amino is a normal-phase, monomeric aminopropylsilane stationary phase that is popular for routine sugar analysis. This phase is suitable for mono- and disaccharide analysis using a refractive index (RI) or evaporative light scattering detector (ELSD). Isocratic elution (e.g., 75:25, acetonitrile:water) must be used with an RI detector but gradient elution can be utilized for higher efficiency separations when using an ELSD or MS detector.

Particle Size (µm)	Length (mm)	ID (mm)	Part No.
3.0	50	4.6	N9303502
3.0	100	4.6	N9303500
3.0	150	4.6	N9303501
5.0	50	4.6	N9303506
5.0	100	4.6	N9303503
5.0	150	4.6	N9303504
5.0	250	4.6	N9303505

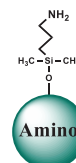

Brownlee Analytical Phenyl

The Analytical Phenyl offer alternative selectivity to the traditional straight alkyl chain phases, especially for aromatic compounds due to *pi-pi* interactions with the phenyl phase.

Particle Size (µm)	Length (mm)	ID (mm)	Part No.
5.0	150	4.6	N9303524

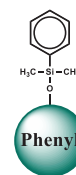

Brownlee Analytical Biphenyl

The Analytical Biphenyl is a unique phase that offers more dispersive (Van Der Waals) interactions and a higher degree of polarizability than the phenyl phase. With the higher degree of dispersive and polar interactions, this column exhibits increased retention for dipolar, unsaturated and conjugated analytes. It also exhibits enhanced selectivity when using methanolic mobile phases.

Particle Size (µm)	Length (mm)	ID (mm)	Part No.
5.0	150	4.6	N9303931
5.0	200	4.6	N9303932

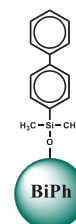

Brownlee Analytical Silica

Analytical silica columns are simply bare silica particles for use in normal phase separations recommended for analysis of highly polar compounds.

Particle Size (µm)	Length (mm)	ID (mm)	Part No.
5.0	150	4.6	N9303525
5.0	200	4.6	N9303526



Brownlee Analytical PAH

The Analytical PAH column was specifically developed for the analysis of polycyclic aromatic hydrocarbons. The PAH stationary phase incorporates a proprietary specially bonded C18 that is shape selective that results in baseline resolution of all 16 priority PAHs in US EPA Method 610. Each lot of Analytical PAH material is tested to ensure baseline resolution all 16 PAHs.

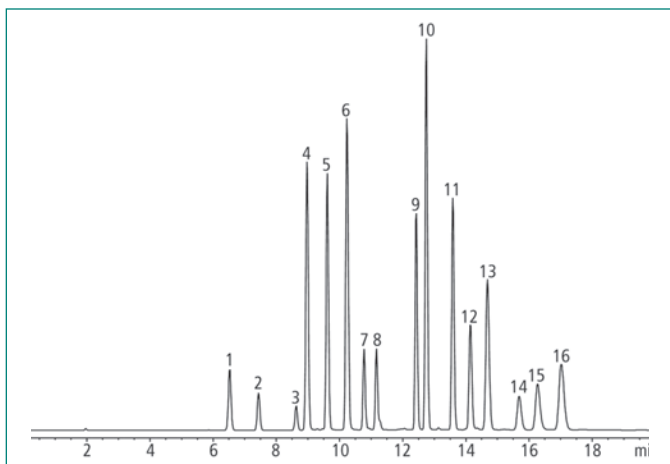

Peak List Concentration (µg/mL)

- | | |
|-------------------|------------------------------|
| 1. naphthalene | 9. benzo (a) anthracene |
| 2. acenaphthylene | 10. chrysene |
| 3. acenaphthene | 11. benzo (b) fluoranthene |
| 4. fluorene | 12. benzo (k) fluoranthene |
| 5. phenanthrene | 13. benzo (a) pyrene |
| 6. anthracene | 14. dibenzo (a,h) anthracene |
| 7. fluoranthene | 15. benzo (ghi) perylene |
| 8. pyrene | 16. indeno (1,2,3-cd) pyrene |

Particle Size (µm)	Length (mm)	ID (mm)	Part No.
4.0	100	4.6	N9303527
4.0	150	3.2	N9303430
4.0	150	4.6	N9303529
4.0	200	4.6	N9303528
4.0	250	2.1	N9303530
4.0	250	4.6	N9303531

Brownlee Analytical DB Columns for HPLC and UHPLC

Brownlee Analytical DB columns are moderately retentive HPLC and sub-2 μm UHPLC columns built on a foundation of high purity, base-deactivated silica that is optimized for UHPLC performance. These columns are available in 3 & 5 μm HPLC particle sizes, as well as a 1.9 μm UHPLC particle size. The silica manufacturing and phase bonding processes are identical for all particle sizes in this series resulting in method scalability from HPLC (3 & 5 μm) to UHPLC (1.9 μm), or vice versa. In addition the larger 140 Å pore size allows analysis of a range of compounds from small molecules to short peptides while the base deactivation makes these columns appropriate for the analysis of acidic, neutral and basic compounds. These columns are excellent replacements for Hypersil® BDS columns.

Features and Benefits

- Conventional and sub-2 μm particles sizes for HPLC and UHPLC systems
- Base-deactivated silica optimized for UHPLC performance from acidic to basic analytes
- All silica prepared by the same process for true HPLC to UHPLC method scalability

Increase efficiency and shorten run times while maintaining selectivity with 1.9 μm Brownlee Analytical DB UHPLC columns

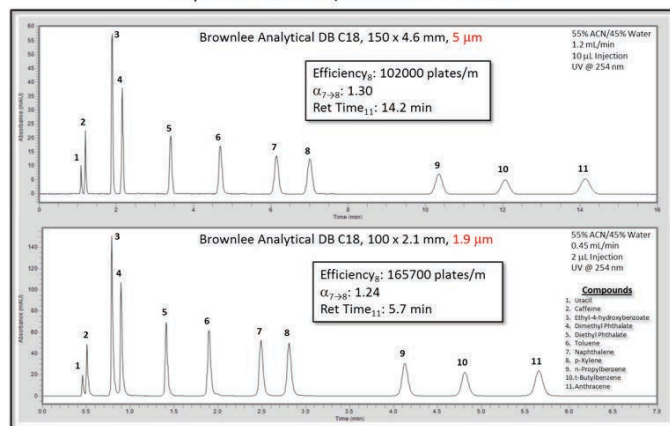

Material Characteristics

Phase*	Particle Sizes (μm)	Pore Size (Å)	Carbon Load	End Capping	pH Stability	Temp. Limit	USP Code
C18	1.9, 3.0, 5.0	140	11%	Yes	2.5 – 8.0	80 °C	L1
Aq C18	1.9, 3.0, 5.0	140	6%	*	2.5 – 8.0	80 °C	L1
IBD	1.9	140	*	Yes	2.5 – 8.0	80 °C	L68
Cyano	1.9, 5.0	140	4%	No	2.5 – 8.0	80 °C	L10
Biphenyl	1.9, 3.0, 5.0	140	8%	Yes	2.5 – 8.0	80 °C	L11
PFP Propyl	1.9, 3.0, 5.0	140	6%	Yes	2.5 – 8.0	80 °C	L43
Silica	1.9	140		No	2.5 – 8.0	80 °C	L3
PAH	1.9	140	*	Yes	2.5 – 8.0	80 °C	

* Proprietary

Brownlee Analytical DB C18

C18 is a good general purpose phase for the analysis of compounds ranging from acid to slightly basic. This is an excellent replacement for very basic compounds. They will have excellent peak shape on these columns with the addition of ion pairing agents to the mobile phase.

Particle Size (μm)	Length (mm)	ID (mm)	Part No.
1.9	30	2.1	N9303911
1.9	50	2.1	N9303912
1.9	100	2.1	N9303913
3.0	30	4.6	N9303887
3.0	50	4.6	N9303888
3.0	100	4.6	N9303889
5.0	50	4.6	N9303890
5.0	150	4.6	N9303891
5.0	250	4.6	N9303892



Brownlee Analytical DB Aqueous C18

The Aqueous C18 contains a proprietary polar side chain functionally bonded C18 that provides a more well balanced retention profile for both polar and non-polar compounds than a traditional C18. This column can be used with a gradient to retain polar compounds that elute near the void time on a standard C18. The Aqueous C18 provides both high reproducibility and compatibility with a wide variety of mobile phases including 100% aqueous mobile phases.

Particle Size (μm)	Length (mm)	ID (mm)	Part No.
1.9	30	2.1	N9303917
1.9	50	2.1	N9303918
1.9	100	2.1	N9303919
3.0	30	4.6	N9303903
3.0	50	4.6	N9303904
3.0	100	4.6	N9303905
5.0	50	4.6	N9303906
5.0	150	4.6	N9303907
5.0	250	4.6	N9303908

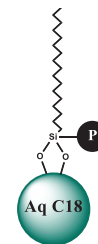

Brownlee Analytical DB IBD

The IBD (intrinsically base-deactivated) is an alkyl phase with a proprietary polar group embedded in the hydrocarbon chain. This phase provides unique retention and selectivity for acidic compounds while the base-deactivation gives symmetrical peak shapes for strong bases that results in one of the most versatile phases available. The IBD can be used in reverse phase mode and is compatible with 100% aqueous mobile phase or in HILIC mode with highly organic mobile phases for improved retention of polar ionic compounds.

Particle Size (µm)	Length (mm)	ID (mm)	Part No.
1.9	30	2.1	N9303920
1.9	50	2.1	N9303921
1.9	100	2.1	N9303922

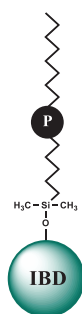

Brownlee Analytical DB Biphenyl

The Analytical Phenyl offers alternative selectivity to the traditional straight alkyl chain phases, especially for aromatic compounds due to *pi-pi* interactions with the phenyl phase.

Particle Size (µm)	Length (mm)	ID (mm)	Part No.
1.9	30	2.1	N9303911
1.9	50	2.1	N9303912
1.9	100	2.1	N9303913
3.0	30	4.6	N9303887
3.0	50	4.6	N9303888
3.0	100	4.6	N9303889
5.0	50	4.6	N9303890
5.0	150	4.6	N9303891
5.0	250	4.6	N9303892

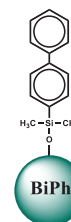

Brownlee Analytical DB Cyano

The Analytical DB and HRes Cyano is a traditional monomeric cyanopropylsilane stationary phase that can be used in normal-phase, reverse-phase and HILIC modes. Use mobile phase pH between 5 and 7 for the best performance in reverse-phase mode. Suitable for analysis of a wide range of compounds from acidic to basic. It is an excellent choice for analysis of protonated bases.

Particle Size (µm)	Length (mm)	ID (mm)	Part No.
1.9	30	2.1	N9303973
1.9	50	2.1	N9303974
1.9	100	2.1	N9303975
5.0	50	4.6	N9303869
5.0	150	4.6	N9303870
5.0	250	4.6	N9303871

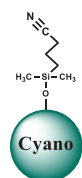

CONVENTIONAL COLUMNS

Brownlee Analytical DB PFP Propyl

The Pentafluorophenyl Propyl phase is uniquely selective for compounds containing basic functional groups and organohalogens. Unlike the cyano phases, PFP Propyl is a better choice for LC/MS analysis because it is reliable and efficient with acidic mobile phases like formic acid and it is very versatile because it can be used with highly aqueous mobile phases as well as HILIC separations. These columns are recommended for the analysis of nucleotides, nucleosides, pyrimidines, purines and halogenated compounds.

Particle Size (µm)	Length (mm)	ID (mm)	Part No.
1.9	30	2.1	N9303914
1.9	50	2.1	N9303915
1.9	100	2.1	N9303916
3.0	30	4.6	N9303895
3.0	50	4.6	N9303896
3.0	100	4.6	N9303897
5.0	50	4.6	N9303898
5.0	150	4.6	N9303899
5.0	250	4.6	N9303900

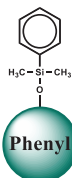

Brownlee Analytical DB PAH

The Analytical HRes PAH column was specifically developed for fast analysis of polycyclic aromatic hydrocarbons. The PAH stationary phase incorporates a proprietary specially bonded C18 that is shape selective that results in baseline resolution of all 16 priority PAHs in US EPA Method 610. The Analytical HRes PAH is capable of separating all 16 PAHs in under 18 minutes with a simple acetonitrile/water gradient.

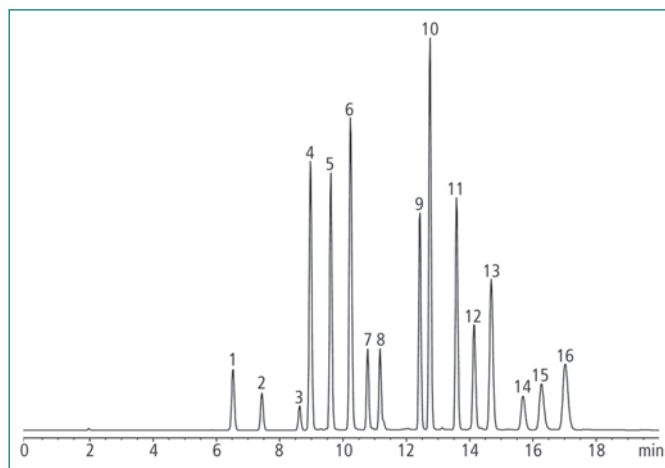

Peak List	Concentration (µg/mL)		
1. naphthalene	100	9. benzo (a) anthracene	50
2. acenaphthylene	100	10. chrysene	50
3. acenaphthene	100	11. benzo (b) fluoranthene	50
4. fluorene	100	12. benzo (k) fluoranthene	50
5. phenanthrene	50	13. benzo (a) pyrene	50
6. anthracene	100	14. dibenzo (a,h) anthracene	50
7. fluoranthene	50	15. benzo (ghi) perylene	50
8. pyrene	50	16. indeno (1,2,3-cd) pyrene	50

Brownlee Analytical DB Silica

Analytical HRes silica columns are simply bare silica particles for use in normal phase separations recommended for fast analysis of highly polar compounds.

Particle Size (µm)	Length (mm)	ID (mm)	Part No.
1.9	30	2.1	N9303970
1.9	50	2.1	N9303971
1.9	100	2.1	N9303972
5.0	50	4.6	N9303879
5.0	150	4.6	N9303880
5.0	250	4.6	N9303981

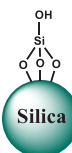

Particle Size (µm)	Length (mm)	ID (mm)	Part No.
1.9	50	2.1	N9303995
1.9	100	2.1	N9303996

Brownlee Aquapore and Bio Columns

Brownlee Aquapore and Bio columns are built on large pore silica for the analysis of large biomolecules such as peptides and proteins. Large pore stationary phases are required for the analysis of large molecules because the analytes need to penetrate the pores to improve retention and resolution. The Aquapore columns are based on 7 µm silica while the Bio columns are based on 5 µm silica for increased plate counts.

Features and Benefits

- Rugged, spherical silica particles with 300 Å pore size
- Excellent choice for separation of peptides, proteins and other large molecules

Material Characteristics

Phase*	Particle Sizes (µm)	Pore Size (Å)	Carbon Load	End Capping	pH Stability	Temp. Limit	USP Code
AP OD-300 (C18)	7.0	300	10%	Yes	2.5 – 8.0	60 °C	L1
AP RP-300 (C8)	7.0	300	5%	Yes	2.5 – 8.0	60 °C	L7
AP AX-300†	7.0	300			2.0 – 8.0	60 °C	
AP CX-300‡	7.0	300			2.0 – 8.0	60 °C	
Bio C18	5.0	300	9%	Yes	2.5 – 8.0	80 °C	L1
Bio C8	5.0	300	5%	Yes	2.5 – 8.0	80 °C	L7

* AP = Aquapore; † AX = Weak Anion Exchange; ‡ CX = Weak Cation Exchange

Brownlee Aquapore 7 µm Columns

Brownlee Aquapore conventional columns built on a 7 µm, 300 Å pore size silica. The OD-300 and RP-300 are reverse-phase silicas modified with C18 and C8, respectively. AX-300 is a weak anion exchanger that is composed of a crosslinked polyethyleneimine phase bonded on the silica surface. CX-300 is a weak cation exchanger that is composed of a polyamide coating containing carboxymethyl groups phase bonded on the silica surface. The reverse-phase columns are also available in microbore (1.0 mm i.d) for increased sensitivity and better compatibility with LC/MS interfaces.

ID (mm)	Length (mm)	OD-300 (C18) Part No.	RP-300 (C8) Part No.	AX-300 Part No.	CX-300 Part No.
1.0	50		07120070		
1.0	100	07120099	07120096		
1.0	250		07120097		
2.1	30	07110234	07110056*	07110074	
2.1	100	07110233	07110058	07110076	
2.1	220	07110236	07110060		
4.6	30	07110235	07110055	07110073	
4.6	100	07110232	07110057	07110075	
4.6	220	07110231	07110059	07110077	
4.6	250	07120073	07120033	07120040	07120043

Brownlee Bio 5 µm Columns

Brownlee Bio C18 and C8 are reverse-phase columns built on a 5 µm particle size, 300 Å pore size silica. The C8 should be used for very hydrophobic analytes because it is less retentive than the C18. They are available in lengths from 50 to 250 mm lengths in 4.6 and 2.1 mm i.d.

Length (mm)	C18		C8	
	2.1 mm ID Part No.	4.6 mm ID Part No.	2.1 mm ID Part No.	4.6 mm ID Part No.
50	N9303654	N9303655	N9303664	N9303665
100	N9303646	N9303647	N9303656	N9303657
150	N9303648	N9303649	N9303658	N9303659
200	N9303650	N9303651	N9303660	N9303661
250	N9303652	N9303653	N9303662	N9303663

Brownlee CHOICE Columns

Brownlee CHOICE HPLC columns are packed with 60 Å pore size, high purity Type B silica with high surface area allowing for dense ligand bonding, high carbon load stationary phases. This results in our most retentive stationary phases which require stronger organic mobile phases. Although these columns can be used with any HPLC system, the high organic mobile phases required for elution make these columns an excellent choice when using MS and ELSD detectors which require efficient mobile phase evaporation for optimum sensitivity. CHOICE columns are available in a 5 µm particle size, 30 – 250 mm column lengths, 4.6 and 2.1 mm ID. The 2.1 mm ID columns are the best fit for MS and ELSD since they require lower flow rates for efficient performance.

Features and Benefits

- Highly retentive, small pore (60 Å), high carbon load columns built on high purity Type B silica
- Require stronger organic mobile phase than any other Brownlee columns
- An excellent Choice for MS and ELSD detectors

Material Characteristics

Phase*	Particle Sizes (µm)	Pore Size (Å)	Carbon Load	End Capping	pH Stability	Temp. Limit	USP Code
C18	5.0	60	27%	Yes	2.5 – 8.0	80 °C	L1
Aq C18	5.0	60	*	No	2.5 – 8.0	80 °C	L1
Basix	5.0	60	12%	Yes	2.5 – 8.0	80 °C	L10
Biphenyl	5.0	60	23%	No	2.5 – 8.0	80 °C	L11
PFP Propyl	3.0, 5.0	60	17%	Yes	2.5 – 8.0	80 °C	L43
Organic Acids	5.0	60	*	Yes	2.5 – 8.0	80 °C	
AK	5.0	60	*	No	2.5 – 8.0	80 °C	

* Proprietary

Pesticides on Brownlee Choice C18

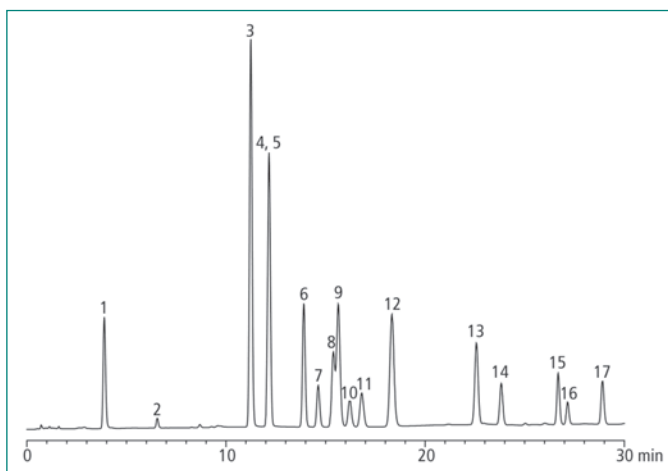

Peak List

- | | |
|----------------------------|--------------------|
| 1. desisopropyl atrazine | 9. secbumeton |
| 2. desethyl atrazine | 10. isoproturon |
| 3. simazine | 11. diuron |
| 4. terbuthylazine desethyl | 12. terbumeton |
| 5. cyanazine | 13. terbuthylazine |
| 6. methabenzthiazuron | 14. linuron |
| 7. chlortoluron | 15. flusilazole |
| 8. atrazine | 16. ethofumesate |
| | 17. neburon |

Brownlee Choice C18

The Choice C18 is the most retentive alkyl phase in our product line. The high density bonding and high carbon load of this phase is made possible by the high surface area of the base silica. These end-capped columns provide excellent peak shapes for a wide range of analytes.

Particle Size (µm)	Length (mm)	ID (mm)	Part No.
5.0	50	2.1	N9303626
5.0	100	2.1	N9303625
5.0	150	2.1	N9303627
5.0	250	2.1	N9303629
5.0	150	4.6	N9303628
5.0	250	4.6	N9303630



Brownlee Choice Aqueous C18

This is a polar embedded C18 that has improved retention and selectivity for polar analytes compared to the standard C18. This phase is highly base deactivated to improve peak shape by reducing silanol activity and can be operated with a 100% aqueous mobile phase. This is an excellent choice for the analysis of a wide variety of compounds by LC/MS screening.

Particle Size (µm)	Length (mm)	ID (mm)	Part No.
5.0	50	4.6	N9303935
5.0	150	4.6	N9303936
5.0	250	4.6	N9303937

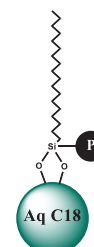

Brownlee Choice Basix

This is a highly retentive phenyl cyano phase especially suited for the separation of basic compounds containing amines.

Particle Size (µm)	Length (mm)	ID (mm)	Part No.
5.0	50	2.1	N9303615
5.0	100	2.1	N9303613
5.0	150	2.1	N9303617
5.0	50	4.6	N9303616
5.0	100	4.6	N9303614
5.0	150	4.6	N9303618
5.0	250	4.6	N9303619

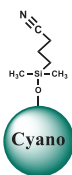

Brownlee Choice Organic Acids

The Choice Organic Acids columns are uniquely designed for enhanced retention and selectivity to resolve organic acids in food such as tartaric and quinic acids on a single 30 cm column using the conditions specified in AOAC method 986.13. Retentions times are very stable on this column even using 100% aqueous mobile phase.

Particle Size (µm)	Length (mm)	ID (mm)	Part No.
5.0	250	2.1	N9303632
5.0	150	4.6	N9303631
5.0	250	4.6	N9303633
5.0	300	4.6	N9303634

Brownlee Choice Biphenyl

This is a highly retentive phase for aromatic and unsaturated compounds with improved selectivity when compared to standard phenyl phases. This phase is an excellent choice for separation of unsaturated compounds such as steroids, tetracyclines and explosives.

Particle Size (µm)	Length (mm)	ID (mm)	Part No.
5.0	50	4.6	N9303940
5.0	100	4.6	N9303941
5.0	150	4.6	N9303942

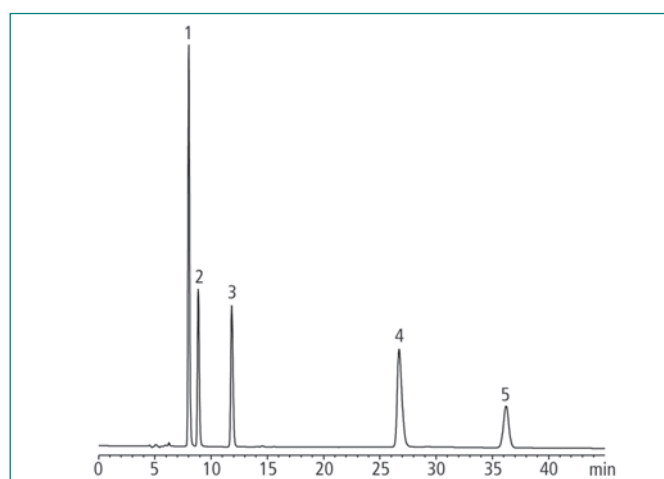
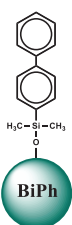

Peak List

1. tartaric acid
2. quinic acid
3. malic acid
4. citric acid
5. fumaric acid

Brownlee Choice PFP Propyl

A phase of pentafluorophenyl with a propyl spacer that is highly retentive for basic analytes, this phase is ideal for the separation of basic drugs prior to MS detection. This bonded phase has been shown to efficiently separate basic drugs in a 90% acetonitrile/water mobile phase, eliminating the need for ion-pairing reagents and ion-suppressing reagents normally used for these separations on C18. This phase is well suited for the separation of tricyclic antidepressants, halogenated compounds and beta-blockers as well as nucleotides, nucleosides, pyrimidines and purines.

Particle Size (µm)	Length (mm)	ID (mm)	Part No.
3.0	50	2.1	N9303635
3.0	50	4.6	N9303636
3.0	100	4.6	N9303637
5.0	30	2.1	N9303640
5.0	50	2.1	N9303641
5.0	100	2.1	N9303638
5.0	150	2.1	N9303643
5.0	50	4.6	N9303642
5.0	100	4.6	N9303639
5.0	150	4.6	N9303644
5.0	250	4.6	N9303645

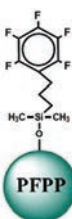

Brownlee Choice AK

The Choice AK column is specifically designed for the separation of DNHP derivatized aldehydes and ketones for environmental methods such as US EPA TO-11 and the California Air Resources Board (CARB) Method 1004. This column is specifically designed to separate the thirteen carbonyl compounds specified in CARB 1004 in under 15 minutes using a simple acetonitrile/water gradient.

Particle Size (µm)	Length (mm)	ID (mm)	Part No.
5.0	200	3.2	N9303884
5.0	200	4.6	N9303885

Brownlee Validated Columns

Brownlee Validated HPLC columns are built on high purity, Type B silica with inherently low silanol activity and very consistent performance from lot-to-lot. This series of columns represent the most choices of stationary phases of any of the column lines offered by PerkinElmer. These columns exhibit excellent peak shapes for a wide range of compounds and are the best choice for pharmaceutical applications that deal with many basic and multi-functional compounds. Choice columns are available in a 3 and 5 μm particle sizes, 30 – 250 mm column lengths in 4.6 and 2.1 mm ID.

Features and Benefits

- Built on high purity, Type B silica for excellent peak shape for a wide range of compounds
- Available in the most choices in stationary phases
- Recommended for pharmaceutical applications with basic and multi-functional compounds

Material Characteristics

Phase	Particle Sizes (μm)	Pore Size (\AA)	Carbon Load	End Capping	pH Stability	Temp. Limit	USP Code
C1	5.0	100	5%		2.5 – 8.0	80 °C	L13
C4	5.0	100	9%	Yes	2.5 – 8.0	80 °C	L26
C8	5.0,0	100	12%	Yes	2.5 – 8.0	80 °C	L7
C18	3.0, 5.0	100	20%	Yes	2.5 – 8.0	80 °C	L1
Aq C18	3.0, 5.0	100	15%	No	2.5 – 8.0	80 °C	L1
IBD	3.0, 5.0	100	12%	No	2.5 – 8.0	80 °C	L68
PFP Propyl	5.0	100	11%	Yes	2.5 – 8.0	80 °C	L43
Phenyl	3.0, 5.0	100	10%	Yes	2.5 – 8.0	80 °C	L11
Cyano	5.0	100	8%	Yes	2.5 – 8.0	80 °C	L10
Amino	3.0, 5.0	100	2%	No	2.5 – 8.0	80 °C	L8
Carbamate	3.0, 5.0	100	*	*	2.5 – 8.0	80 °C	
Quat	5.0	100	*	*	2.5 – 8.0	80 °C	

* Proprietary

Acetaminophen and Narcotic Analgesics on Brownlee Validated C18

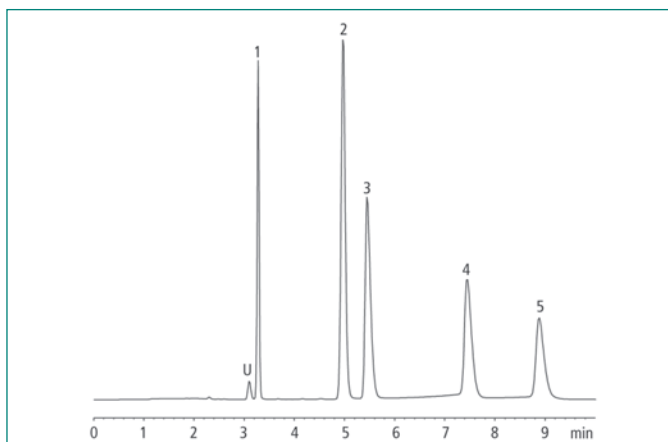

Peak List

1. morphine sulfate
2. acetaminophen
3. codeine phosphate
4. oxycodone HCL
5. hydrocodone bitartrate

Recommended Guard Cartridge N9303694
 Recommended Guard Holder N9303713

Brownlee Validated C1

The Validated C1 is an exceptionally stable C1 phase. This is the least retentive reversed-phase packing.

Particle Size (μm)	Length (mm)	ID (mm)	Part No.
5.0	150	4.6	N9303718
5.0	250	4.6	N9303719



Brownlee Validated C4

The Validated C4 is exceptionally stable packing that is base deactivated with a high bonding coverage. C4 is a less retentive reverse-phase than C8 or C18.

Particle Size (μm)	Length (mm)	ID (mm)	Part No.
3.0	150	4.6	N9303851
5.0	150	4.6	N9303720
5.0	250	4.6	N9303721

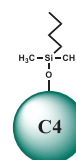

Brownlee Validated C8

The Validated C8 is a reverse-phase alkyl that provide less hydrophobic retention but better peak shape for basic compounds than a traditional C18. Like C18, C8 ia a good general purpose reverse phase that is suitable for a wide range of compounds from acidic to slightly basic.

Particle Size (µm)	Length (mm)	ID (mm)	Part No.
5.0	100	2.1	N9303564
5.0	150	2.1	N9303566
5.0	150	4.0	N9303848
5.0	100	4.6	N9303565
5.0	150	4.6	N9303567
5.0	250	4.6	N9303568

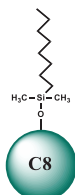

Brownlee Validated C18

The Validated C18 is a good general purpose reverse-phase column with moderate to high retention for hyphobic compounds. The high purity, Type B silica has low silanol activity resulting in excellent peak shapes even for basic analytes. This phase is more retentive than C8 and recommended for a wide range of analystes from acidic to slightly basic.

Particle Size (µm)	Length (mm)	2.1 mm ID		4.6 mm ID	
		Part No.	Part No.	Part No.	Part No.
3.0	100	N9303551		N9303552	
5.0	50	N9303562		N9303563	
5.0	100	N9303553		N9303554	
5.0	150	N9303557		N9303558	
5.0	200			N9303559	
5.0	250	N9303560		N9303561	



Brownlee Validated Aqueous C18

The Aqueous C18 contains a proprietary polar side chain functionally bonded C18 that provides a more well balanced retention profile for both polar and non-polar compounds than a traditional C18. This column can be used with a gradient to retain polar compounds that elute near the void time on a standard C18. The Aqueous C18 provides both high reproducibility and compatability with a wide variety of mobile phases including 100% aqueous mobile phases. This is an excellent choice for the analysis of a wide variety of compounds by LC/MS screening.

Particle Size (µm)	Length (mm)	2.1 mm ID		4.6 mm ID	
		Part No.	Part No.	Part No.	Part No.
3.0	30	N9303540			
3.0	50	N9303541		N9303542	
3.0	100	N9303537		N9303538	
3.0	150	N9303539			
5.0	30			N9303550	
5.0	100	N9303543		N9303544	
5.0	150	N9303545		N9303546	
5.0	200			N9303547	
5.0	250	N9303548		N9303549	

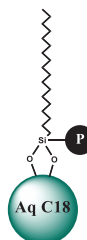

Brownlee Validated PFP Propyl

The pentafluorophenyl propyl phase is a great choice for retention and selectivity of charged bases, amine containing compounds and electronegative compounds. Unlike the cyano phases, PFP Propyl is a better choice for LC/MS analysis because it is reliable and efficient with acidic mobile phases like formic acid and it is very versatile because it can be used with highly aqueous mobile phases as well as HILIC separations. These columns are recommended for the analysis of nucleotides, nucleosides, pyrimidines, purines and halogenated compounds.

Particle Size (µm)	Length (mm)	2.1 mm ID Part No.	4.6 mm ID Part No.
5.0	50	N9303601	
5.0	100	N9303598	
5.0	150		N9303598
5.0	150		N9303599
5.0	250		N9303600

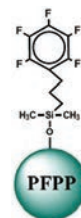

Brownlee Validated Phenyl

The Validated Phenyl is a high-purity, highly retentive, base-deactivated phase with alternate selectivity to straight chain hydrocarbon phases, especially for aromatic compounds.

Particle Size (µm)	Length (mm)	2.1 mm ID Part No.	4.6 mm ID Part No.
3.0	30	N9303604	
3.0	50	N9303602	N9303603
5.0	100	N9303605	N9303606
5.0	150		N9303607

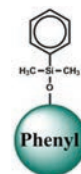

* N9303604 actual size is 100mm x 1.0mm

Brownlee Validated Cyano

The Validated Cyano is a traditional monomeric cyanopropylsilane stationary phase that can be used in normal-phase, reverse-phase and HILIC modes. Use mobile phase pH between 5 and 7 for the best performance in reverse-phase mode. Suitable for analysis of a wide range of compounds from acidic to basic, it is an excellent choice for analysis of protonated bases.

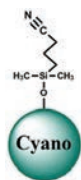

Particle Size (µm)	Length (mm)	2.1 mm ID Part No.	4.6 mm ID Part No.
5.0	30		N9303578
5.0	100	N9303572	N9303573
5.0	150	N9303574	N9303575
5.0	220		N9303576
5.0	250		N9303577

Brownlee Validated Amino

The Validated Amino is a normal-phase, monomeric aminopropylsilane stationary phase that is a popular for routine sugar analysis. This phase is suitable for mono- and disaccharide analysis using a refractive index (RI) or evaporative light scattering detector (ELSD). Isocratic elution (e.g., 75:25, acetonitrile:water) must be used with an RI detector but gradient elution can be utilized for higher efficiency separations when using an ELSD or MS detector.

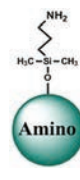

Particle Size (µm)	Length (mm)	ID (mm)	Part No.
3.0	150	3.2	N9303847
5.0	100	2.1	N9303532
5.0	150	2.1	N9303533
5.0	150	4.6	N9303534
5.0	220	4.6	N9303535
5.0	250	4.6	N9303536

Brownlee Validated Carbamate

The Validated Carbamate is a proprietary phase specifically designed for carbamate analysis. This unique stationary phase is capable of separating the 10 target carbamates in just over 10 minutes. The column is capable of analyzing as many as three samples per hour as opposed to less than two per hour on a conventional C18 column. These columns are compatible with both LC/MS and fluorescence detection with post-column derivitization.

		4.6 mm I.D.
Particle Size (µm)	Length (mm)	Part No.
3.0	50	N9303570
3.0	100	N9303569
5.0	250	N9303571

Brownlee Validated Quat

The Validated Quat is a proprietary, highly retentive, high-purity, base-deactivated, reverse phase specifically designed for the analysis of paraquat, diquat and other quaternary amines.

		4.6 mm I.D.
Particle Size (µm)	Length (mm)	Part No.
5.0	150	N9303886

Brownlee Spheri-5® and Spheri-10® Columns

Brownlee Spheri columns are built on small pore (80 Å) silica in 5 and 10 µm particle sizes for analysis of small molecules. These columns are available in three different reverse-phases (C2, C8, C18) and the silica normal phase covers a range of analyte polarities. The Spheri C18 is the most retentive reverse-phase in this family while the C8 is less retentive and can be used for more basic small molecules. Spheri-5 C18 is also available in a monofunctional (comb type) and polyfunctional (ODS) bonding for different analyte selectivities. All Spheri conventional columns are only available in 250 mm length and 4.6 mm i.d.

Features and Benefits

- Small pore (80 Å), 5 & 10 µm, 250 x 4.6 mm columns for small molecule analysis
- C18, C8 and C2 reverse-phases for a range of analyte polarities

Material Characteristics

Phase	Particle Sizes (µm)	Carbon Load	End Capping	USP Code	Part No.
Spheri-10 C2	10		No	L16	07120005
Spheri-5 C8	5	6%	Yes	L7	07120012
Spheri-5 C18	5	11%	Yes	L1	07120016
Spheri-10 C18	10	11%	Yes	L1	07120001
Spheri-5 C18 ODS (Polyfunctional)	5	14%	Yes	L1	07120019
Spheri-5 Silica	5			L3	07120023

CONVENTIONAL COLUMNS - GUARD COLUMNS

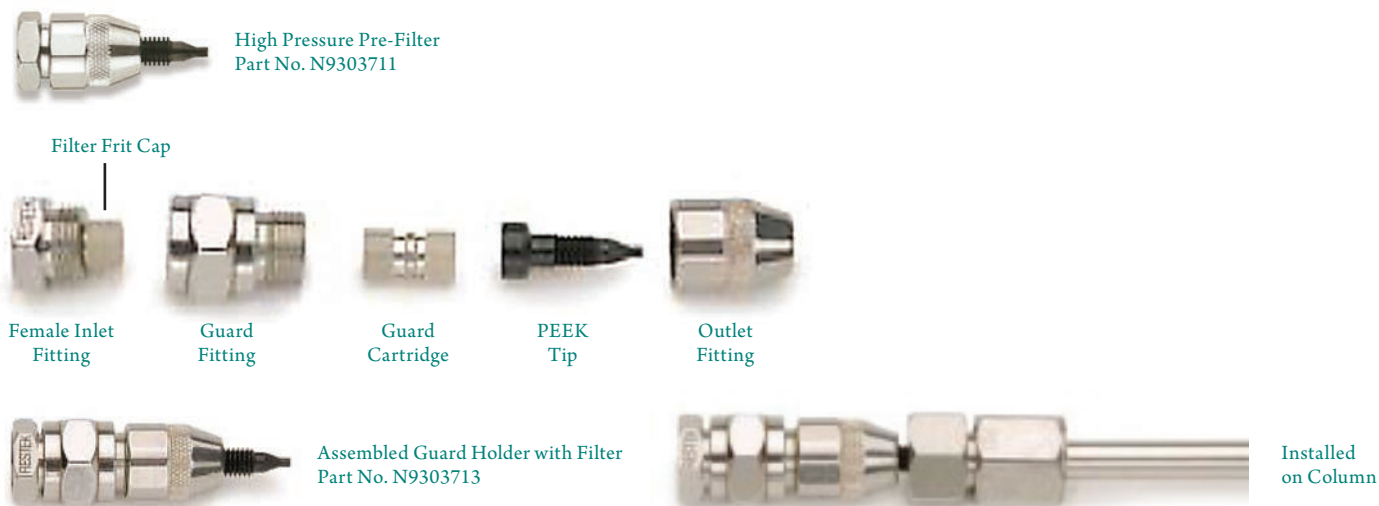

Brownlee Conventional Guard Column Holders and Pre-Filters

The Brownlee conventional column pre-filter and guard column holder systems allow you to select from three different levels of column protection that couple directly to the head of your column. The high pressure filter (N9303711) simply contains a filter frit selectable in two different diameters (2.0 mm or 4.0 mm) and two different frit porosities (2.0 μm or 0.5 μm) for basic protection against particulates in the sample or mobile phase. The 10 mm guard cartridge holder without a pre-filter (N9303713) provides protection against compounds that irreversibly absorb onto the stationary phase. The 10 mm guard cartridge holder with a pre-filter (N9303712) provides the ultimate in column protection with a selectable filter frit for elimination of particulates along with a guard cartridge packed with a selectable stationary phase to protection against compounds that irreversibly absorb onto the stationary phase.

Guard Column Holders and Pre-Filters

Description	Part No.
10 mm guard cartridge holder with filter	N9303713
10 mm guard cartridge holder without filter	N9303712
High pressure filter	N9303711
Peek tip standard fittings	N9303714
Replacement cap frits 2.0 mm, 2.0 μm	N9303717
Replacement cap frits 4.0 mm, 0.5 μm	N9303716
Replacement cap frits 4.0 mm, 2.0 μm	N9303715

Brownlee Analytical Guard Cartridges

Length: 10 mm Particle Size: 5 μm Quantity: 3/pkg

Phase	2.1 mm ID	4.0 mm ID
	Part No.	Part No.
Amino	N9303674	N9303675
C18	N9303676	N9303677
C8	N9303678	N9303679
Cyano	N9303680	N9303681
PAH	N9303682	N9303683
Phenyl	N9303684	N9303685
Silica	N9303686	N9303687

Brownlee Analytical Guard Cartridges

Length: 10 mm Particle Size: 5 μm Quantity: 3/pkg

Phase	4.0 mm ID
	Part No.
C18	N9303867
Aq C18	N9303909
Cyano	N9303872
Biphenyl	N9303893
Phenyl	N9303877
PFP Propyl	N9303901
Silica	N9303882

Brownlee Analytical DB and HRes Guard Cartridges

Length: 20 mm Particle Size: 5 µm Quantity: 3/pkg

Phase	4.0 mm ID Part No.
C18	N9303868
Aq C18	N9303910
Cyano	N9303873
Biphenyl	N9303894
Phenyl	N9303878
PFP Propyl	N9303902
Silica	N9303883

Brownlee Choice Guard Cartridges

Length: 10 mm Particle Size: 5 µm Quantity: 3/pkg

Phase	2.1 mm ID Part No.	4.0 mm ID Part No.
Basix	N9303666	N9303667
C18	N9303668	N9303669
Aq C18		N9303938*
Organic Acids	N9303670	N9303671
PFP Propyl	N9303672	N9303673
Biphenyl		N9303943**

*This column is also available in 20mm x 4.0mm under Part No. N9303937
 ** This column is also available in 20mm x 4.0mm under Part No. N9303944

Brownlee Bio DB Guard Cartridges

Length: 10 mm Particle Size: 5 µm Quantity: 3/pkg

Phase	2.1 mm ID Part No.	4.0 mm ID Part No.
C18	N9303708	N9303707
C8	N9303709	N9303710

Brownlee Validated Guard Cartridges

Length: 10 mm Particle Size: 5 µm Quantity: 3/pkg

Phase	2.1 mm ID Part No.	4.0 mm ID Part No.
Amino	N9303688	N9303689
Aq C18	N9303690	N9303691
C1		N9303722
C4		N9303723
C8	N9303695	N9303696
C18	N9303693	N9303694*
Carbamate	N9303697	N9303698
Cyano	N9303699	N9303700
IBD	N9303701	N9303702
PFP Propyl	N9303703	N9303704
Phenyl	N9303705	N9303706

*This column is also available in 10µm under Part No. N9303692

Brownlee Sorbents

PerkinElmer Brownlee™ cartridge columns are offered in a wide range of sorbent material. Choose the right sorbent for the analysis and mode of separation being used.

Aquapore® – is a wide-pore, silica-based support suitable for the separation of large biopolymers.

Spheri-5® – is a small-pore, silica-based solvent for separating small molecules. Both monofunctional (comb-type) and polyfunctional (polymerized loop-type) C8 and C18 sorbents are available.

Polypore® – is a polymer-based (microporous, 10 µm) sorbent for the analysis of organic acids and sugars.

Validated™ – is a small-pore, silica-based C18 sorbent for small molecules, specifically for consistent pharmaceutical assays.

Pecosphere™ – is a small-pore, silica-based sorbent for HPLC of small molecules.

Reduced Activity – is a small-pore, base deactivated silica-based, reversed-phase sorbent (C18 or C8) developed for HPLC of basic analytes and pharmaceuticals.

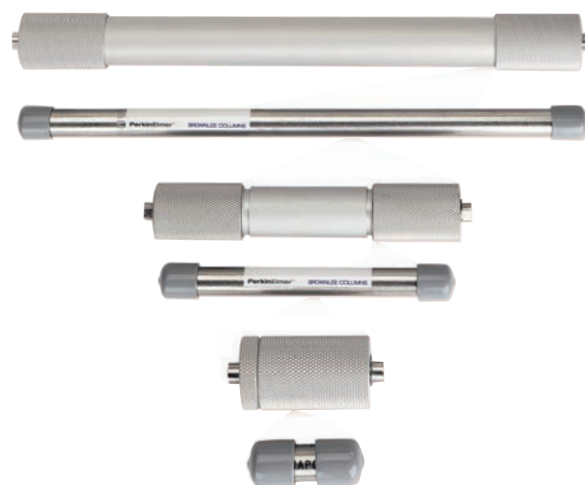

CHOICE™ – is a small-pore, base deactivated silica-based, reversed-phase sorbent (C18) developed for LC/MS separations.

Peco HCODS – is especially suited for reversed-phase separation of proteins and peptides.

Brownlee Cartridge Columns

Column	Functionality	Pore Diameter Å	% Carbon	End Cap	Applications
Aquapore	AX-300 (anion exchange)	300			Silica-based support for larger anionic compounds
Aquapore	OD-300 (C18)	300	10	Yes	Silica-based support for larger compounds by reversed-phase
Aquapore	RP-300 (C8)	300	5	Yes	Same as above, but for slightly more polar compounds
Aquapore	BU-300 (C4)	300	3	Yes	Same as above, but for even somewhat more polar compounds
Choice	C18	100	12	Yes	For high speed/efficiency separation of basic compounds/pharmaceuticals
Choice	C8	100	7	Yes	For high speed/efficiency separation of basic compounds/pharmaceuticals
Choice	PFPP (Pentafluorophenylpropyl)	100	5	Yes	For high speed/efficiency separation of basic drugs, especially for LC/MS
Pecosphere	C18, monofunctional	80	11	Yes	Reversed-phase column for fast separation of smaller compounds
Pecosphere CR	C18	80	11	Yes	Same as above, but for more basic compounds
Pecosphere CR	C8	80	11	Yes	Same as above, but, also, for slightly more polar compounds
Peco HCODS	C18, polyfunctional	300	9	No	Especially suited for reversed-phase separation of proteins and peptides
Polypore	CA (calcium form), Mixed Mode	Microporous			Especially suited for separation of organic acids, as well as sugars
Polypore	H (hydrogen form), Mixed Mode	Microporous			Especially suited for separation of sugars, as well as organic acids
Reduced Activity	C18	80	12	Yes	Reversed-phase sorbent geared for fast separation of basic compounds/pharmaceuticals
Reduced Activity	C8	80	5	Yes	Same as above, but for slightly more polar compounds
Spheri-5	RP-18 (monofunctional C18)	80	11	Yes	Reversed-phase separation of smaller compounds
Spheri-5	ODS (polyfunctional C18)	80	14	Yes	Same as above, but with somewhat different selectivity
Spheri-5	RP-8 (monofunctional C8)	80	6	Yes	Reversed-phase separation of more basic smaller compounds
Spheri-5	Phenyl (C5)	80	6	Yes	Especially suited for hydrophobic interaction separation of biomolecules, where the activity of the compound must be preserved
Spheri-5	Amino	80	3	No	Normal-phase separation of smaller, relatively more polar compounds
Spheri-5	Cyano	80	4	No	Same as above, but with somewhat different selectivity
Spheri-5	Silica	80			Same as above, but with different selectivity
Validated	C18	100	18	Yes	Reversed-phase separations in which very little variation in both lot-to-lot and column-to-column variability can be tolerated
VeloSep	RP-18 (C18)	100	14	Yes	Reversed-phase column for high through-put and minimal solvent usage
VeloSep	RP-8 (C8)	100	7	Yes	Same as above, but for slightly more polar compounds

Brownlee Aquapore Columns

Brownlee Aquapore columns are built on large pore 300 Å, 7 µm particle size silica for the analysis of large biomolecules such as peptides and proteins. Large pore stationary phases are required for the analysis of large molecules because the analytes need to penetrate the pores to improve retention and resolution. The OD-300, RP-300 and BU-300 are reverse-phase silicas modified with C18, C8 and C4, respectively. The longer alkyl chains in the stationary phase result in stronger retention of hydrophobic molecules (i.e. retention C18 > C8 > C4). The AX-300 is a weak anion exchanger composed of cross-linked polyethyleneimine coated on the silica surface.

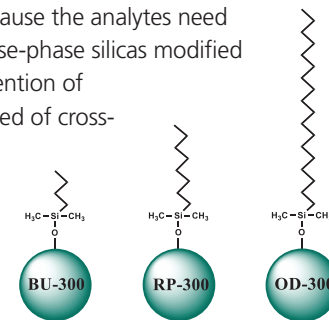

Features and Benefits

- Rugged, spherical silica particles with 300 Å pore size
- Excellent choice for separation of peptides, proteins and other large molecules
- Available in ion-exchange and reverse-phases

Material Characteristics

Phase*	Particle Sizes (µm)	Pore Size (Å)	Carbon Load	End Capping	pH Stability	Temp. Limit	USP Code
BU-300 (C4)	7.0	300	3%	Yes	2.5 – 8.0	60 °C	L26
RP-300 (C8)	7.0	300	5%	Yes	2.5 – 8.0	60 °C	L7
OD-300 (C18)	7.0	300	10%	Yes	2.5 – 8.0	60 °C	L1
AX-300*	7.0	300			2.5 – 8.0	60 °C	L14

* Weak Anion Exchange

Phase	Length (mm)	Quantity	2.1 mm i.d.		4.6 mm i.d.		Column Holder Code *	
			Part No.	Part No.	w/o Guard	w/ Guard		
BU-300	30	2 Pack	07110062	07110061	A	A + K + L		
	100	Each	07110064		C	D		
	220	Each	07110066		G	H		
RP-300	30	2 Pack	07110056	07110055	A	A + K + L		
	100	Each	07110058	07110057	C	D		
	220	Each	07110060	07110059	G	H		
OD-300	30	2 Pack	07110234	07110235	A	A + K + L		
	100	Each	07110233	07110232	C	D		
	220	Each	07110236	07110231	G	H		
AX-300	30	2 Pack	07110074	07110073	A	A + K + L		
	100	Each	07110076	07110075	C	D		
	220	Each		07110077	G	H		

* See Page 153 for column holder codes and part numbers

Brownlee Spheri-5® and Spheri-10® Cartridge Columns

The Brownlee Spheri line of columns is based on a small-pore (80 Å) silica-based sorbent for optimized for separating small molecules. Spheri-5® columns are based on 5 µm particle size silica and Spheri-10® incorporates a 10 µm silica particle. Spheri-5 columns are available in both reverse phases (RP-8, RP-18, ODS & Phenyl) and polar normal phases (amino, cyano & silica). The Spheri-5 reverse phase C18 type sorbents are available in a monofunctional comb-type (RP-18) and a polyfunctional loop-type (ODS) which provide slight differences in selectivity.

Features and Benefits

- Small pore size (80 Å) designed for separating small molecules
- Reverse phase sorbents in 5 µm and 10 µm particles sizes and normal phase 5 µm particles
- Available in ion-exchange and reverse-phases

Material Characteristics

Phase*	Particle Sizes (µm)	Pore Size (Å)	Carbon Load	End Capping	pH Stability	Temp. Limit	USP Code
RP-8	5.0, 10.0	80	6%	Yes	2.5 – 8.0	60 °C	L7
RP-18	5.0, 10.0	80	11%	Yes	2.5 – 8.0	60 °C	L1
ODS	5.0	80	14%	Yes	2.5 – 8.0	60 °C	L1
Phenyl	5.0	80	6%	Yes	2.5 – 8.0	60 °C	L11
Amino	5.0	80	3%	No	2.5 – 8.0	60 °C	L8
Cyano	5.0	80	4%	No	2.5 – 8.0	60 °C	L10
Silica	5.0	80			2.5 – 8.0	60 °C	L3

Phase	Length (mm)	Particle Size	Qty	2.1 mm i.d.		4.6 mm i.d.		Column Holder Code *	
				Part No.	Part No.	w/o Guard	w/ Guard		
Spheri-5 RP-8	30	5 µm	2 Pack	07110002	07110001	A	A + K + L		
	100	5 µm	Each	07110004	07110003	C	D		
	220	5 µm	Each	07110006	07110005	G	H		
Spheri-5 RP-18	30	5 µm	2 Pack	07110014	07110013	A	A + K + L		
	100	5 µm	Each	07110016	07110015	C	D		
	220	5 µm	Each	07110018	07110017	G	H		
Spheri-5 ODS	30	5 µm	2 Pack	07110020	07110019	A	A + K + L		
	100	5 µm	Each	07110022	07110021	C	D		
	220	5 µm	Each	07110024	07110023	G	H		
Spheri-5 Phenyl	30	5 µm	2 Pack		07110025	A	A + K + L		
	100	5 µm	Each	07110028	07110027	C	D		
	220	5 µm	Each		07110029	G	H		
Spheri-5 Amino	30	5 µm	2 Pack		07110037	A	A + K + L		
	100	5 µm	Each		07110039	C	D		
	220	5 µm	Each	07110042	07110041	G	H		
Spheri-5 Cyano	30	5 µm	2 Pack	07110044	07110043	A	A + K + L		
	100	5 µm	Each	07110046	07110045	C	D		
	220	5 µm	Each		07110047	G	H		
Spheri-5 Silica	30	5 µm	2 Pack	07110032	07110031	A	A + K + L		
	100	5 µm	Each	07110034	07110033	C	D		

* See Page 153 for column holder codes and part numbers

Brownlee Pecosphere Cartridge Columns

PerkinElmer pioneered the development of Fast HPLC and introduced the popular 3 µm particle size “3 x 3” Columns (33 mm x 4.6 mm) in the 1980s. The “3 x 3” columns are capable of very rapid analysis and still they are still very popular in many laboratories because of the economical price and reliable performance. The Pecosphere cartridges are also available 83 mm long “3 x 8” and 150 mm long “3 x 150” columns (4.6 mm ID) for the separation of more complex mixtures.

Pecosphere columns are packed with rugged, high purity silica in 3 µm and 5 µm particle sizes. These columns are available in 80 Å pore size particles with standard end-capping for the analysis of acidic and neutral analytes and a special end-capped Reduced Activity (RA) version that is especially suited for the analysis basic analytes. There is a large pore (300 Å), non-end-capped, polyfunctional C18 version (HCODS) for the separation of peptides and proteins. In addition the 10 µm particles size C18 Scavenger cartridge designed to remove contaminants from the mobile phase when installed prior to the HPLC injector.

Features and Benefits

- The Pecosphere “3 x 3” column is the world’s first fast HPLC column introduced in the 1980’s
- Reduced Activity C18 & C8 with low silanol activity for the analysis of basic compounds
- 300 Å pore size Peco HCODS for the separation of peptides and proteins

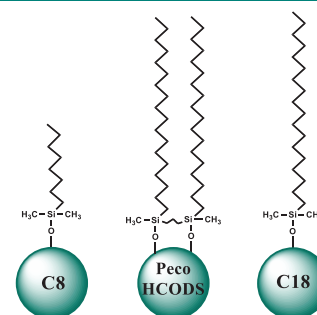
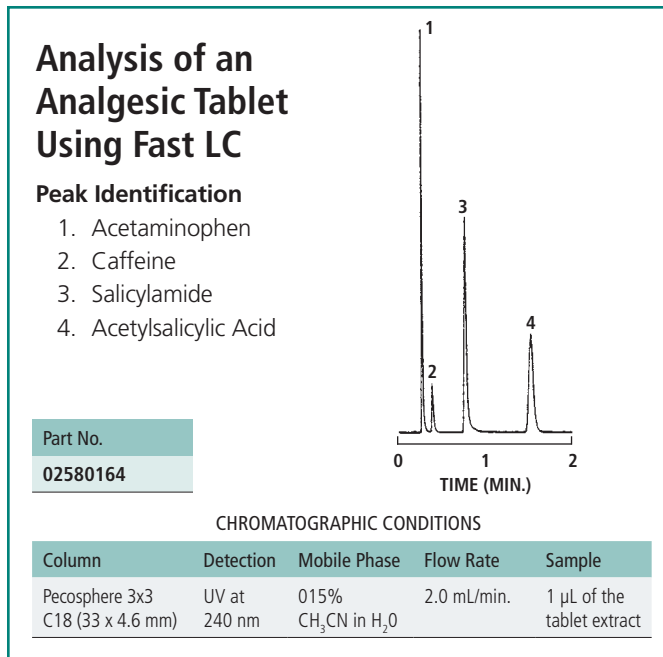

Material Characteristics

Phase	Particle Sizes (µm)	Pore Size (Å)	Carbon Load	Surface Area (M ² /g)	End Capping	pH Stability	USP Code
C18	3.0, 5.0	80	11%	170	Yes	2.0 – 8.0	L1
RA C8	3.0, 5.0	80	5%	200	Yes	2.0 – 8.0	L7
RA C18	3.0, 5.0	80	12%	200	Yes	2.0 – 8.0	L1
Peco HCODS	5.0	300	9%	90	No	2.5 – 8.0	L1
C18 Scavenger	10.0	80	11%	170	Yes	2.0 – 8.0	L1

Phase	Length (mm)	Particle Size	Qty	4.6 mm i.d.	
				Part No.	Column Holder*
Aquapore Octyl (C8)	33	3 µm	5 Pack	02580164	T
	83	3 µm	Each	02580166	U
	150	5 µm	Each	02580169	F
Red. Act. C18	33	3 µm	5 Pack	02580195	T
	83	3 µm	Each	02580194	U
	150	5 µm	Each	N9303396	F
Red. Act. C8	33	3 µm	5 Pack	02580191	T
	83	3 µm	Each	02580192	U
	150	5 µm	Each	02580168	F

Phase	Length (mm)	Particle Size	Qty	4.6 mm i.d.	
				Part No.	Column Holder*
HCDOS	150	3 µm	Each	02580213	F
C18 Scavenger	33	10 µm	5 Pack	02580202	T
Silica Scavenger	33	10 µm	5 Pack	02580203	
C18 Scavenger Kit†	33	10 µm	Each	02580204	

* See Page 153 for column holder codes and part numbers
† Scavenger kit includes C18 cartridge (02580202) and holder (07150028)

Brownlee Validated Cartridge Columns

The Brownlee Validated C18 sorbent is derived from a neutral "Type B" silica with inherent low silanophilic activity. Each sorbent lot is tested to meet stringent specifications for the separation of basic, neutral, and acidic test probes. Column lifetime studies and additional selectivity evaluations using real samples are also conducted. A high-temperature bonding technique is coupled with an exhaustive end-capping procedure to ensure maximum coverage of the silica surface. A proprietary treatment step is used to further eliminate any trace residual metals in the silica that create active adsorptive sites. The result is a highly deactivated column which yields excellent peak shape for difficult basic analytes, pharmaceuticals, and small peptides.

Features and Benefits

- Base deactivated compatible with acids, bases and neutrals
- Guaranteed batch-to-batch reproducibility
- Test chromatogram and Certificate of Compliance shipped with each column (except NewGuard® and 30 mm columns)

**Validated C18
(100 x 4.6 mm),
75/25 MeOH/Water
1 mL/min., 30 °C,
230 nm detection**

Performance of Validated Column with basic, acidic, and neutral test probes.

Part No.
00402241

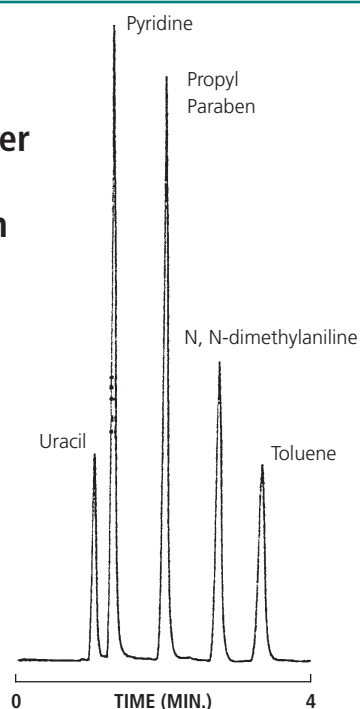

Material Characteristics

Phase	Particle Sizes (µm)	Pore Size (Å)	Carbon Load	End Capping	Surface Area (m ² /g)	pH Stability	Temp. Limit	USP Code
Validated C18	5.0	100	18%	Yes	350	2.5 – 8.0	60 °C	L1

Phase	Length (mm)	Particle Size	Quantity	2.1 mm i.d.		4.6 mm i.d.		Column Holder Code *	
				Part No.	Part No.	w/o Guard	w/ Guard		
Validated C18	30	5 µm	Each		00402239	A	A + K + L		
	100	5 µm	Each	00402240	00402241	C	D		
	150	5 µm	Each		00403053	F	F + K + L		
	220	5 µm	Each		00402243	G	H		

* See Page 131 for column holder codes and part numbers

Brownlee Polypore® Cartridge Columns

Brownlee Polypore® columns are 10 mm, microporous polymer based columns especially suited for the analysis of sugars and organic acids.

Features and Benefits

- Available in calcium (CA) and hydrogen (H) counter ion forms.
- For analysis of sugars and organic acids

Material Characteristics

Phase	Particle Sizes (µm)	Pore Size	pH Stability	Temp. Limit	USP Code
Polypore® CA	10.0	Microporous	1 - 14	90 °C	L19
Polypore® H	10.0	Microporous	1 - 14	90 °C	L17

Phase	Length (mm)	Particle Size	Quantity	4.6 mm i.d.	
				Part No.	Column Holder*
Polypore® H	30	10 µm	2 Pack	07110085	A
	100	10 µm	Each	07110087	C
	220	10 µm	Each	07110089	G
Polypore® CA	30	10 µm	2 Pack	07110091	A
	100	10 µm	Each	07110093	C
	220	10 µm	Each	07110095	G

* See Page 153 for column holder codes and part numbers

Organic Acids

Peak Identification

- | | |
|-----------------------|------------------|
| 1. Oxalic Acid | 5. Succinic Acid |
| 2. Citric Acid | 6. Formic Acid |
| 3. α-Ketogutaric Acid | 7. Acetic Acid |
| 4. Malic Acid | 8. Fumaric Acid |
| | 9. Butyric Acid |

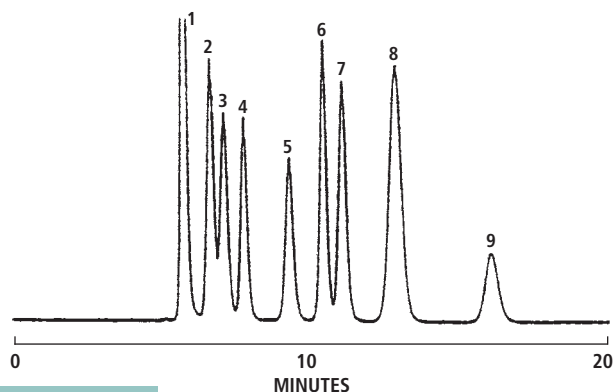

Part No.
07110089

CHROMATOGRAPHIC CONDITIONS

Column	Detection	Mobile Phase	Flow Rate	Temperature
Polypore H (220 x 4.6 mm i.d.)	210 nm	0.01 N H ₂ SO ₄	0.15 mL/min.	25 °C

Brownlee Prep-10 Semi-Preparative Cartridge Columns

The Brownlee Prep-10 columns are 10 mm i.d. cartridges packed with 20 µm particle size, 300 Å pore size Aquapore® sorbents for easy scale up from our 7 µm analytical Aquapore® columns. These unique 100 mm and 250 mm cartridges incorporate a moveable inlet plug and filter which compensates for changes in bed volume with continued use. The typical capacity of the 250 mm cartridge is 50 mg to 1 g depending on the resolution and purity required.

Features and Benefits

- Rugged, spherical silica particles with 300 Å pore size
- Excellent choice for separation of peptides, proteins and other large molecules
- Available in ion-exchange and reverse-phases

Material Characteristics

Phase	Particle Sizes (µm)	Pore Size (Å)	Carbon Load	End Capping	Surface Area (m ₂ /g)	pH Stability	Temp. Limit	USP Code
Aquapore Octyl (C8)	20.0	300	5%	Yes	100	2.5 – 8.0	60 °C	L7
Aquapore ODS (C18)	20.0	300	10%	Yes	100	2.5 – 8.0	60 °C	L1

Phase	Length (mm)	Particle Size	Quantity	4.6 mm i.d.	
				Part No.	Column Holder*
Aquapore Octyl (C8)	100	20 µm	Each	07110165	R
	250	20 µm	Each	07110166	S

Phase	Length (mm)	Particle Size	Quantity	4.6 mm i.d.	
				Part No.	Column Holder*
Aquapore ODS (C18)	100	20 µm	Each	07110114	R
	250	20 µm	Each	07110163	S

* See Page 131 for column holder codes and part numbers

Brownlee CHOICE Cartridge Columns for LC/MS

The Brownlee CHOICE cartridge columns are specifically designed in column dimensions for high throughput LC/MS analysis. These cartridges are available in three reverse phases (C8, C18 and PFPP) with particle sizes of 3 µm and 5 µm. The smaller internal diameter columns offer high sensitivity even with lower sample concentrations. The pentafluorophenyl propyl (PFPP) phase is ideal for the analysis of basic drugs. This phase has been shown to efficiently separate basic drugs in a 90% acetonitrile/water mobile phase eliminating the need for ion suppression agents commonly used with C18 column for the analysis of these types of compounds.

Features and Benefits

- Suitable for high throughput LC/MS analysis
- PFPP phase for basic drugs

Material Characteristics

Phase	Particle Sizes (µm)	Pore Size (Å)	Carbon Load	End Capping	Surface Area (m ² /g)	pH Stability	Temp. Limit	USP Code
CHOICE C8	3.0	100	7%	Yes	350	2.5 – 8.0	60 °C	L7
CHOICE C18	3.0, 5.0	100	12%	Yes	350	2.5 – 8.0	60 °C	L1
CHOICE PFPP	5.0	100	5%	Yes	350	2.5 – 8.0	60 °C	L43

Phase	Length (mm)	Particle Size	Quantity	2.1 mm i.d.	3.21 mm i.d.	4.6 mm i.d.	Column Holder*
				Part No.	Part No.	Part No.	
CHOICE® C8	30	3 µm	Each	N2580012			A
	50	3 µm	Each		N2580013		B
CHOICE® C18	30	3 µm	Each		N2580003		A
	30	5 µm	Each			N2580020	A
	50	5 µm	Each		N2580022	N2580021	B
CHOICE® PFPP	30	5 µm	Each	N2580042			A

* See Page 153 for column holder codes and part numbers

Brownlee VeloSep® Cartridge Columns

Brownlee VeloSep® columns are 3.2 mm i.d. cartridges packed with 3 µm reverse phase silica stationary phases for high throughput analysis.

Features and Benefits

- 3.2 mm i.d. improves sensitivity while reducing mobile phase consumption
- Available in 3 µm C8 and C18 sorbents in 40 mm and 100 mm column lengths

Material Characteristics

Phase	Particle Sizes (µm)	Pore Size (Å)	Carbon Load	End Capping	Surface Area (m ² /g)	pH Stability	Temp. Limit	USP Code
VeloSep RP-8 (C8)	3.0	100	7%	Yes	170	2.5 – 8.0	60 °C	L7
VeloSep RP-18 (C18)	3.0	100	14%	Yes	170	2.5 – 8.0	60 °C	L1

Phase	Length (mm)	Particle Size	Quantity	4.6 mm i.d.	
				Part No.	Column Holder*
VeloSep RP-8	40	3 µm	2 Pack	07110189	A
	100	3 µm	Each	07110190	C
VeloSep RP-18	40	3 µm	2 Pack	07110191	A
	100	3 µm	Each	07110192	C

* See Page 153 for column holder codes and part numbers

NewGuard Columns

NewGuard cartridges are small guard cartridges (15 mm x 3.2 mm i.d.) packed with 5 or 7 µm sorbents. NewGuard cartridges prolong column life by eliminating particulates, contaminants, and strongly bound sample components. They act as replaceable disposable heads of your analytical columns. There is negligible loss of efficiency and little effect on retention or resolution. NewGuards are available in a convenient 3-pack and can be coupled directly to any MPLC cartridge with a union (07150018).

Features and Benefits

- Prolong column life by 2 to 5 times
- Protect your column from particulates and strongly bound sample components
- Optimized dimensions to prevent loss of resolution
- Easy coupling to MPLC cartridges or conventional columns
- Finger-tight seal to 7,000 psi using NewGuard holders
- Can be used for sample preconcentration (connected to sample injection loop)

15 mm cartridge*, 3.2 mm i.d., 3 per pkg.

Description	Size	Shape	Part No.
Amino, Aquapore Amino	7 µm	Spherical	07110098
Anion, Aquapore Anion	7 µm	Spherical	07110102
Cyano, Aquapore Cyano	7 µm	Spherical	07110100
Diol, Aquapore Diol	7 µm	Spherical	07110105
Phenyl, Aquapore Phenyl	7 µm	Spherical	07110096
RP-2, Aquapore Dimethyl	7 µm	Spherical	07110086
RP-4, Aquapore Butyl	7 µm	Spherical	07110088
RP-8, Aquapore Octyl	7 µm	Spherical	07110090
RP-18, Aquapore ODS	7 µm	Spherical	07110092
Silica, Aquapore Silica	7 µm	Spherical	07110106
Validated®, C18	5 µm	Spherical	00402237

* Requires holder (07150001)

Note: Actual bed length of NewGuard is about 13 mm

Standards Solutions

Description	Part No.
Test Mix	
LC Gradient Test Mix	N9334010
Universal Test Mix for Reversed-phase (5 mL/pkg)	00890893
Standards	
HPLC SV Calibration Mix No.5/610 PAH	00891542
HPLC 610 Calibration Mix A	00891543
HPLC 610 Calibration Mix B	00891544



NewGuard cartridges directly coupled to a 220 mm MPLC cartridge and connected externally to a 250 mm conventional column.

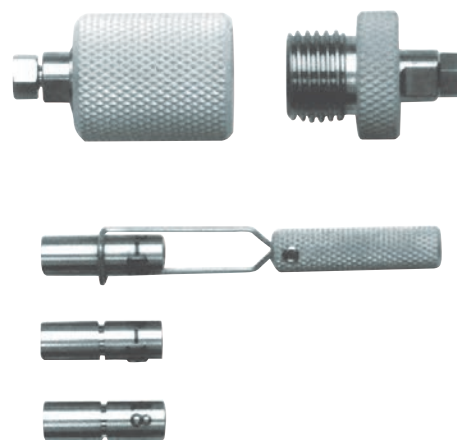























View of the NewGuard holder and a NewGuard 3-pack.

NewGuard Accessories

Replacement Seals for MPLC and Prep-10 Holders

Description	Part No.
Prep-10 Inlet Seal	
One each (Prep-10 Seal Replacement Kit Tools Required)	07150012
Prep-10 Outlet Seal	
One each (Prep-10 Seal Replacement Kit Tools Required)	07150026
Seals for MPLC Holders	
Two 7,000 psi seals (Seal Replacement Kit Tools Required)	07150024
Seal Replacement Kit for MPLC Holders	
Tools and Two 7,000 psi Seals	07150023

Finger-Tight Holders

	Code	Name	Description	Part No.
MPLC Cartridge Holders				
	A	30 mm Holder	Single 30 mm holder for MPLC cartridges	07150013
	B	50 mm Holder	Single 50 mm holder for MPLC cartridges	N2580030
	C	100 mm Holder	Single 100 mm holder for MPLC cartridges	07150014
	D	100 mm NewGuard System Holder	MPLC holder for directly coupling a NewGuard and a 100 mm cartridge	07150016
	E	130 mm System Holder	Holder for directly coupling a 30 mm and 100 mm MPLC cartridge	07150032
	F	150 mm Holder	Single 150 mm holder for MPLC cartridges	07150030
	G	220 mm Holder	Single 220 mm holder for MPLC cartridges	07150015
	H	220 mm NewGuard System Holder	MPLC holder for directly coupling a NewGuard and a 220 mm cartridge	07150017
	I	250 mm Holder	Single 250 mm holder for MPLC cartridges	07150031
	J	NewGuard Holder	Holder for a single, stand-alone NewGuard cartridge	07150001
	K	Union	For direct coupling of two cartridge holders or a NewGuard to any cartridge holder. (NewGuard end assembly required)	07150018
	L	NewGuard End Assembly	Used with union to couple a NewGuard to any cartridge holder	07150002
	M	End Assembly	End assembly for any MPLC holder body	07150019
	N	30 mm Holder Body	Holder body for 30 mm MPLC cartridge	07150020
	O	100 mm Holder Body	Holder body for 100 mm MPLC cartridge	07150021
	P	220 mm Holder Body	Holder body for 220 mm MPLC cartridge	07150022
	Q	Universal Holder Kit	Includes 100 mm and 220 mm holder bodies, 2 end assemblies, 1 union and 1 NewGuard end assembly	07150025
Prep-10 Cartridge Holders				
	R	100 mm Prep-10 Holder	Holder for a single 100 mm Prep-10 MPLC cartridge	07150005
	S	250 mm Prep-10 Holder	Holder for a single 250 mm Prep-10 MPLC cartridge	07150006
Pecosphere Cartridge Holders				
	T	33 mm Pecosphere Holder	Holder for a 33 mm fast LC Pecosphere cartridge. (Not for use with MPLC cartridges)	07150028
	U	83 mm Pecosphere Holder	Holder for a 83 mm fast LC Pecosphere cartridge. (Not for use with MPLC cartridges)	07150029
	V	100 mm Pecosphere Holder	Holder for a 100 mm fast LC Pecosphere cartridge. (Not for use with MPLC cartridges)	02580225

INTERCHANGEABLE FOR YOUR SAMPLE

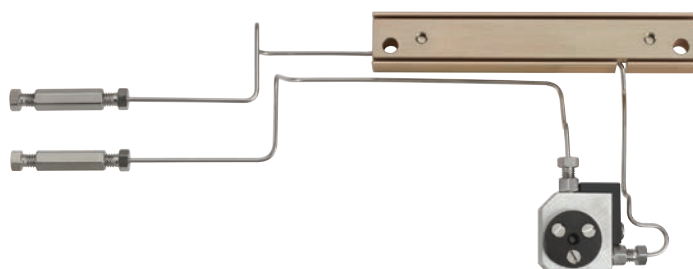

Bio Conversion Kits

There are two kits available; one that contains all of the parts necessary to convert the Series 200 pump and Series 200 autosampler for Bio applications. The other contains all of the parts necessary to convert only the Series 200 Pump for Bio applications.

Description	Part No.
S200 Pump and S200 Autosampler Conversion Kit	N2910035
S200 Pump Conversion Kit	N2910036

Pump Seal Kits

Description	Part No.
High Pressure Piston Seal Replacement Kit Includes: Seals (4), Backup Rings and O-Rings	N2910383
Micropump Piston Seal Replacement Kit Includes: Seals and O-Rings	N2910384
Series 200 Pump Maintenance Kit Includes: Fuses, Seals, O-Rings and Seal Tools	N2910345



Detector Backpressure Regulator

The detector backpressure regulator is a device that is attached to the outlet of the detector to prevent outgassing in the flowcell, eliminating variations to the detector baseline.

Description	Material	Part No.
40 psi inline backpressure regulator		N2925090
2 – 5K psi variable backpressure regulator		N2925091
Backpressure Regulator Adjustable from 15 – 59 psi	Stainless Steel	09907126

Flexar UV/Vis, Series 200/785A UV/Vis, Flexar PDA and Series 200 EP

These flowcells provide the highest detection limits possible for your sample. The 6 mm pathlength flowcell has been optimized for lower-dispersion LC analysis and is the perfect choice when using narrowbore, 2.1 mm or microbore, 1 mm columns (see Figure 1). The 3 mm pathlength is the choice for semiprep LC to avoid detector saturation at high-solute concentrations.

UV/Vis, PDA, FL and LC-135/235 FLOWCELLS

Description	Size	Part No.
Flowcells for Flexar FX-UV/Vis UHPLC Detectors		
Flowcell	6 mm x 2.4 μ L	N2925090
Flowcell Kit (includes flowcell & detector head plate w/ gasket)	6 mm x 2.4 μ L	N2920070
Flowcells for Flexar FX-UV/Vis UHPLC Detectors		
Flowcell Kit (includes flowcell w/ heat exchanger and zdv unions)	10 mm x 15 μ L	N2920070
Flowcell	10 mm x 15 μ L	N2920124
Flowcell Assembly (w/ zdv unions)	6 mm x 2.4 μ L	29000544
Prep Flowcell Assembly (w/ zdv unions)	3 mm x 1.7 μ L	29000545
Flowcells for 785A UV/Vis Detectors		
Flowcell	8 mm x 12 μ L	29000542
Flowcell Assembly (w/ heat exchanger and zdv unions)	8 mm x 12 μ L	N2920117
Flowcells for Flexar FX-PDA UHPLC and Series 275 PDA Detectors		
Flowcell (dual-lensed)	6 mm x 2.4 μ L	N2920128
Flowcells for Flexar and Series 200EP PDA Detectors		
Flowcell	10 mm x 15 μ L	N2920126
Flowcell Assembly	10 mm x 15 μ L	N2920160
Flowcells for Series 200 PDA Detectors		
Flowcell	10 mm x 12 μ L	N2922107
Flowcell	4.5 mm x 5 μ L	N2922030
FL 3 μ L Flowcell w/ Assembly		N2922211
Flowcells for LC-135/235 PDA Detectors		
Flowcell Assembly (w/ heat exchanger)	10 mm x 8 μ L	N2350211
Flowcell	10 mm x 8 μ L	N2350162

FOR OUTSTANDING PERFORMANCE



UV/VIS Deuterium
Detector Lamp

Our extensive quality control and inspection process demands the very best quality sources. Choosing a PerkinElmer deuterium, tungsten or xenon source provides outstanding ultraviolet and true visible performance.

- Exceptional performance anywhere in the detector's 190 – 700 nm wavelength range
- Lamp changes are quick and easy due to a unique self-aligning lamp mount

UV/VIS Detector Lamps

Components	Part No.
Flexar Series/Series 200/785A UV/VIS Detector Lamps	
Deuterium Lamp	N2920149
Tungsten Lamp	N2920146
LC-295 UV/VIS Detector Lamps	
Deuterium Lamp	02712266

Refractive Index Detector Lamps

The Flexar Series/Series 200/200s Refractive Index, with its deflection-type design, allows sensitive detection of these compounds with low noise and drift characteristics.

Components	Part No.
Series 200/200a	
Refraction Index (RI) Lamp	02712273



Series 200/200 EP
Photo Diode Array Detector Lamp

Photo Diode Array Detector Lamps

The Flexar Series/Series 200/200 EP Photo Diode Array Detector provides true UV/VIS detection and high resolution spectral data. The excellent signal-to-noise characteristics make it ideally suited for low-volume or low concentration samples.

Components	Part No.
Flexar/Series 200 EP	
Deuterium Lamp	N2925030
Tungsten Lamp	N2922011
Series 200	
Deuterium Lamp	N2922046
Tungsten Lamp	N2922011
LC-135C/235	
Detector Lamp	N2351285

Fluorescence Detector Lamps

The major benefit afforded by fluorescence detection is the inherent high sensitivity of the technique coupled with outstanding specificity. The Series 200a Fluorescence Detector provides signal to noise ratio of >700:1 from trace analysis using a 150 W xenon source.

Components	Part No.
Flexar/Series 200/200a	
Xenon Lamp	N2922082
Flexar/Series 200/200a	
Xenon Lamp	L2251157
Festoon Lamp	04969486

ENHANCE PUMP PERFORMANCE

Vacuum Degassing Kits

Using a solvent degassing system will extend the performance of your pump. PerkinElmer offers both vacuum degassing systems that can handle all your degassing requirements.

On-Line Vacuum Degasser Kit

This is a low-volume, high efficiency on-line module for the removal of dissolved gasses from HPLC solvents. The vacuum degasser is available in 3 and 5 channel models to support isocratic, binary and quaternary pumps as well as degassing of autosampler flush solvent.



Description	Part No.
3-channel Vacuum Degassing Package. Includes: a Vacuum Degasser, one 1 L Bottle with Cap, one 2 L Bottle with Cap, one Organizer Tray and Accessory	N2600571
5-channel Vacuum Degassing Package. Includes: a Vacuum Degasser, two 1 L Bottle with Caps, two 2 L Bottles with Caps, Solvent Tray and Organizer	N2600570
Binary Bottle Cap Kit. Includes: two Caps, Tubing, Fittings and Labels required for two Solvent Bottles	N2600522
Quaternary Bottle Cap Kit. Includes: four Caps, Tubing, Fittings and Labels required for four Solvent Bottles	N2600523

Liquid Chromatography Laboratory Bottle Kits

Contents	Part No.
1x5 Liter Bottle with Cap and PTFE Insert, 2 Meters PTFE 1/8" Tubing and 1x10 µm SS Solvent Frit	N2601610
1x2 Liter Bottle with Cap and PTFE Insert 1 Meter PTFE 1/8" Tubing and 1x10 µm SS Solvent Frit	N2601611
1x1 Liter Bottle with Cap and PTFE Insert 1 Meter PTFE 1/8" Tubing and 1x10 µm SS Solvent Frit	N2601612
1x0.5 Liter Bottle with Cap and PTFE Insert 1 Meter PTFE 1/16" Tubing and 1x40 µm SS Solvent Frit	N2601613
1 Cap with PTFE Insert 1 Meter PTFE 1/8" Tubing and 1x10 µm SS Solvent Frit	N2601614
1 Cap with PTFE Insert 1 Meter PTFE 1/16" Tubing and 1x40 µm SS Solvent Frit	N2601615
1x0.5 Liter Bottle with Cap and Dual PTFE Insert 2 pcs of 2 Meter PTFE 1/8" Tubing (Piston Wash Function)	N2601616
1 Cap with Dual PTFE Insert 2 pcs of 2 Meter PTFE 1/8" Tubing and 1x10 µm SS Solvent Frit (Piston Wash Function)	N2601617

Replacement Vacuum Degasser Bottles

Description	Part No.
1 L Glass Bottle	N2600497
2 L Glass Bottle	N2600498

Degassing Kits - Helium

Helium degassing solvent packages are available in a choice of three solvent configurations. Each kit contains a manifold, bottles, and all required tubing and fittings. The helium manifold has been designed to prevent accidental over-pressurization and to eliminate the possibility of solvent migrating back into the helium supply lines. The glass bottles supplied with the kits are specially coated to ensure safety and prevent solvent leakage if accidentally dropped or otherwise broken.

Description	Part No.
Isocratic Solvent Package Includes: one 2 L glass bottle kit, with cap assembly, and a helium manifold	N2600491
Quaternary Solvent Package Includes: two 1 L glass bottle kits and two 2 L glass bottle kits, with cap assemblies, one helium manifold, and a solvent organizer accessory	N2600506

Degassing System Spares - Helium

Description	Size	Part No.
1 L Glass Bottle		N2600497
2 L Glass Bottle		N2600498
2 L Glass Bottle Kit		N2600457
5 L Glass Bottle		N2600499
5 L Glass Bottle Kit		N2600458
Autosampler Flush Bottle Kit		N2600459
Bottle Cap Assembly For 1 L and 2 L glass bottles. Includes: sparger (10 µm), solvent filter (10 µm), connecting fittings		N2600495
Bottle Cap Assembly For 5 L glass bottle		N2600496
Helium Manifold Kit 5 psi regulator		N2600284
Kel-F Ferrule	1/8 in.	09903771
Tefzel Nut	1/8 in.	N2601189

Supply Connectors - Helium

Each solvent reservoir system requires high-purity helium, either to pressurize or to degas the solvents. The helium pressure regulator with shut-off valve can deliver from 5 to 180 psi of pressure from an external tank. We offer all the fittings needed to connect a helium source to your solvent reservoir system. Refer to your operator's manual for step-by-step installation instructions.

Description	Part No.
1 L Glass Bottle Reduces 1/4 to 1/8 in.	09903906
Regulator 5 to 180 psi with outlet shut-off valve	00230090
Teflon Tubing Helium and Solvent Supply, per 1 ft. length 1/8 in. o.d. x .06 in. i.d.	02506483

SEALS, PISTONS, AND CHECK VALVES

Check valves, which include a sealing washer, are easy to install using the optional Torque Wrench kit. For all PerkinElmer pumps an intermediate check valve is required. The input check valve, which is identical, should be ordered.

Description	Flexar LC or Series 200 (6000 psi)				FX-10
	Standard Stainless Steel Part No.	Micropump Stainless Steel Part No.	Biocompatible Titanium Part No.	Micropump Stainless Steel Part No.	
1 Standard High Pressure Piston Seal	09908324	09923367†	09907338	09923367†	
1 High Pressure Piston with Seal - Chemically Resistant	09907345				
2 High Pressure Piston with Seal Backup Ring	02542076	†	02542076	†	
3 High Pressure Piston Seal PTFE O-ring	09902128	09902128	09902018	09902128	
4 Low Pressure Piston Seal	09907339	09923366	09907339	09923366	
5 Low Pressure Piston Seal Backup Guide Bushing	02542313	N2915006	N2061174	N2915006	
6 High Pressure Piston	N2600124	N2910511	N2600124	N2910511	
7 Low Pressure Piston	N2600104	N2910512	N2600104	N2910515	
8 Intel Check Valve	02540177	02540177	N2600226	02540177	
9 Intermediate Check Valve	02540177	02540177	N2600226	N2916052	
10 Outlet check Valve	02540197	02540197	N2600192	02540154	

* Refer to Users Manual for complete illustrated parts list

† High Pressure Piston Seal Backup ring (2) is included with the Standard High Pressure Piston Seal (1)

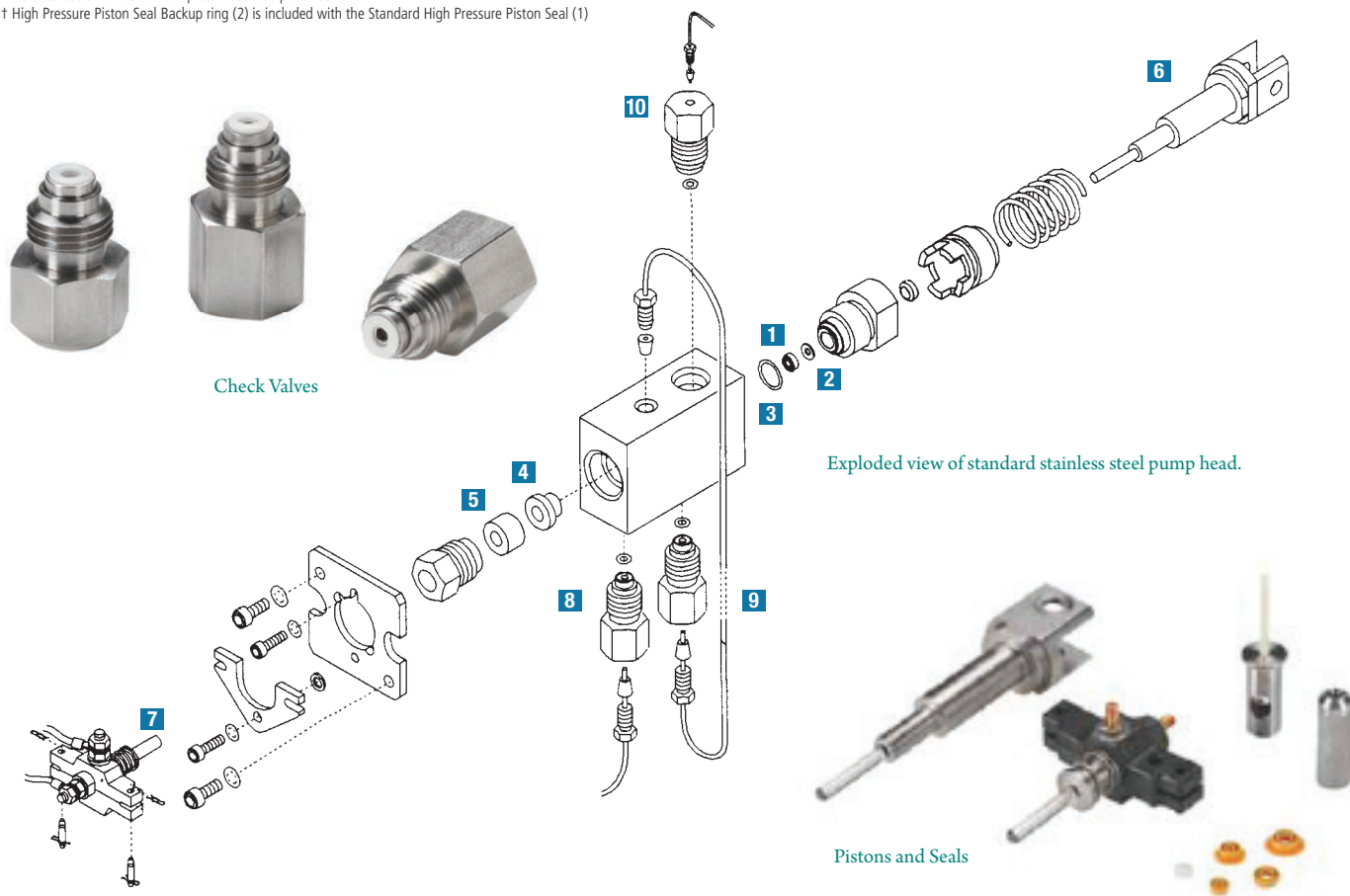

FLEXAR FX-15 & FX-20 PUMP HEAD

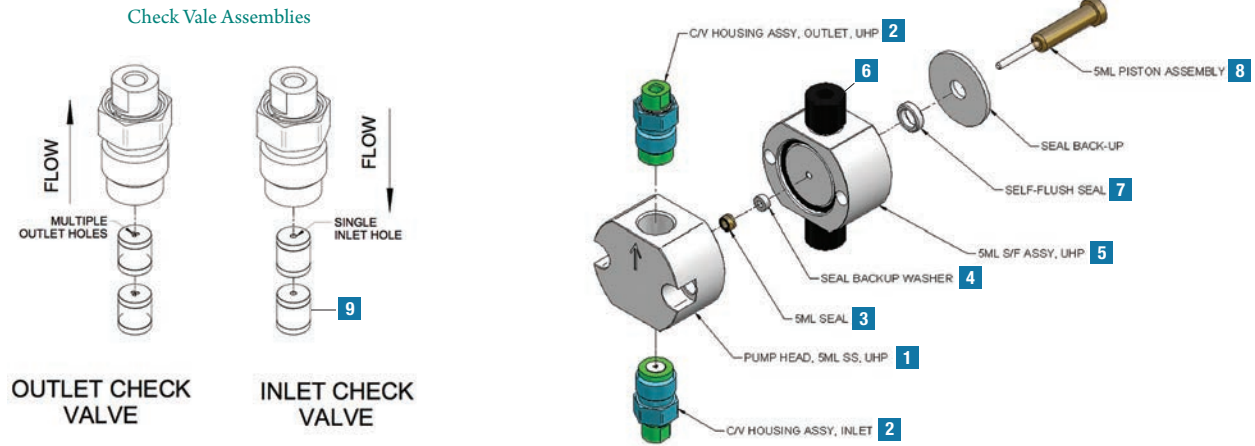

Description	FX-15		FX-20	
	Standard Stainless Steel	Part No.	Standard Stainless Steel	Biocompatible Titanium
1 Pump Head (SS - 2 Pack, Titanium - Each)	†		N2911251	N2911244
2 Inlet/Outlet Check Valve Kit (1 inlet & 1 outlet)	N2911220		N2911220	NA
3 High Pressure Piston Seal	*		*	*
4 High Pressure Piston Seal Backup Washer	*		*	*
5 Self Flush Assembly w/ Seals	N2911235		N2911235	N2911245
6 Self-Flush Check Valve Kit (1 inlet & 1 outlet)	N2911236		N2911236	N2911236
7 Self-Flush Seal	*		*	*
8 Piston	N9308535		N9308535	N9308535
9 Check Valve Capsule (SS - Each, Titanium - 4 Pack)	N2911239		N2911239	N2911240
10 0.5 mm Tee Assembly Frit	N2911224		N2911224	N2911241

* Seals sold in Kits only. See Preventive Maintenance and Seal Kits
 † Replacement with FX-20 pump heads (N2911251) is recommended.)

Preventive Maintenance (PM) and Seal Kits

Description	Part No.
FX-15 PM Kit Complete (4 Heads)	N2911249
FX-15 Single Head Seal Kit (1 Head)	N2911221
Fx-15 Heavy Duty HP Seals (1 Head)	N2918536
FX-20 PM Seal Kit (4 Heads)	N2911250

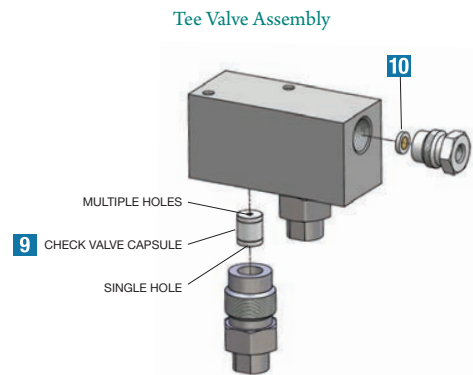

Bio Conversion Kit

For the Series 200 Pump and Series 200 Autosampler. The kit contains all of the parts necessary to convert the pump and the autosampler for Bio applications.

Description	Part No.
Bio Conversion Kit	N2910035

Maintenance Kits and Tools

Description	Part No.
Biocompatible Piston Seal Replacement Kit Includes: four seals, backup rings, and O-Rings	N2910385
Check Valve Torque Wrench	02540871
Diaphragm for Pulse Compensator	N2601316
High Pressure Piston Seal Replacement Kit Includes: four seals, backup rings, and O-Rings	N2910383
Insertion Tool	N2601503
Micropump Piston Seal Replacement Kit	N2910384
Pulse Compensator Repair Kit Includes: diaphragm, elastomer plug, and seal	N2600313
Seal Removal Tool	N2601295
Series 200 Bio LC Pump Maintenance Kit Includes: fuses, seals, O-Rings, and seal tools	N2910346
Series 200 Pump Maintenance Kit Includes: fuses, seals, O-Rings, and seal tools	N2910345

Manuals and Accessories

Description	Part No.
Pump Backpressure Regulator (to generate backpressure for applications less than 250 psi)	02540272
Pump Priming Syringe (30 mL, plastic)	09904849
Series 200 Operator's Manual	09938910
Series 200 Pump Injector Bracket	N2910349

Solvent Sparger and Solvent Filters

Solvent filters remove unwanted particulate matter from the LC instrument. Spargers connect directly to the solvent delivery line and are easily removed for cleaning. The scavenger column is ideal for eliminating particulate material from solvents.



Solvent Filters

Solvent Spargers, Filters and Scavengers

Description	Size	Part No.
Solvent Reservoir Sparger		
Stainless Steel	10 µm	09903610
Titanium	10 µm	N2600070
Stainless Steel	40 µm	09903615
Titanium	40 µm	N2600089
Solvent Filters/Scavengers		
In-Line Solvent Filter System		09903606
In-Line Solvent Filter Replacement Kit		02540311
In-Line Solvent Filter System, Titanium		N2600259
Replacement 2 µm Titanium Filter Element		N2601477
Replacement Seal for In-Line Solvent Filter		N2601262
3 cm Scavenger Cartridge Holder		02580178
Spheri-5 C18 10 µm Scavenger Column (5 pack)		02580202
LC System Accessories		
Solvent waste cup		N2916019
Drain Cup		N2916085
90° Elbow Adapter, ¼" ID HDPP		09220102
Tubing Clip (U-shaped, Polypropylene)		NX598006
Polypro Elbow Barbs		09220102
Large ID (11 mm) Silicone Tubing (5 ft)		N2916016
Manual Injector Bracket (Magnetic Clip-on)		N2931275

Pulse Compensators

The pulse compensator combines high-efficiency pulse smoothing with a low void volume. A Teflon diaphragm separates a reservoir filled by an RTV elastomer plug. Normal use will necessitate the eventual replacement of the diaphragm.

Description	Part No.
Diaphragm for Pulse Compensator	N2601316
Pulse Compensator Repair Kit Includes: diaphragm, elastomer plug, and seal	N2601313

Series 200 Pump Solvent Upgrade Kits

The unique design of the PerkinElmer Series 200 Pump allows it to easily be upgraded for additional solvent capability right in your laboratory as your needs change. Installation of the kit by a PerkinElmer Service and Support is recommended, but not included. Contact your local PerkinElmer representative for more information.

Description	Part No.
Series 200 Binary to Quaternary Upgrade Kit	N2910344
Series 200 Isocratic to Binary Upgrade Kit	N2910342
Series 200 Isocratic to Quaternary Upgrade Kit	N2910343

Stainless Steel Sample Loops

For Flexar FX UHPLC Autosampler (up to 18,000 psi operation)

Stainless Steel loops required for use with FX-10 or FX-15 systems operating above 6,200 psi.

High Pressure Stainless Steel Sample Loops

Description	Size	Part No.
Sample Loop, SS	2 µL	N2936071
Sample Loop, SS	5 µL	N2936056
Sample Loop, SS	10 µL	N2936057
Sample Loop, SS	20 µL	N2936058
Sample Loop, SS	50 µL	N2936059
Sample Loop, SS	100 µL	N2936060
Sample Loop, SS	200 µL	N2936061
Sample Loop, SS	500 µL	N2936062
Sample Loop, SS	1 mL	N2936063
Sample Loop, SS	2 mL	N2936064
Sample Loop, SS	5 mL	N2936065

PEEK Sample Loops

For Series 200/225 and Flexar LC Autosamplers (up to 6,200 psi operation)

These loops are compatible with all standard Flexar autosamplers as well as Series 225 autosamplers. PEEK loops cannot be used above 6,200 psi operation therefore are NOT compatible with standard Flexar autosamplers. Stainless steel loops required for use with FX-10 or FX-15 UHPLC systems operating above 6,200 psi.

Description	Size	Part No.
PEEK Sample Loop	2 µL	N2936072
PEEK Sample Loop	5 µL	N2936073
PEEK Sample Loop	10 µL	N2936074
PEEK Sample Loop	20 µL	N2936075
PEEK Sample Loop	50 µL	N2936076
PEEK Sample Loop	100 µL	N2936077
PEEK Sample Loop	250 µL	N2936078
PEEK Sample Loop	500 µL	N2936079
PEEK Sample Loop	1 mL	N2936080
PEEK Sample Loop	2 mL	N2936081
PEEK Sample Loop	5 mL	N2936082

Tubing Accessories

Clean-Cut™ tubing tool is designed to cut PTFE, Tefzel® and polymers in general but, in particular, PEEK tubing. A unique safety locking mechanism secures the blade when not in use.



Description	Part No.
Clean-Cut Tubing Cutter	ED020015
Clean-Cut Tubing Replacement Blade	ED020016
Cable/Tubing clip (U-Shaped)	NX598006
Stick-on Tubing Organizer (Gray Plastic)	NX598006

PEEK Tubing

PEEK tubing has the strength required to withstand continuous use at HPLC pressure without swelling or bursting. Use PEEK with virtually any organic or inorganic liquid. PEEK tubing is not affected by halide salts, high-strength buffers or other aggressive mobile phases that degrade stainless steel.

Description	Length	Part No.
1/16 in O.D. x 0.007 in I.D.	5 ft	N9302678
1/16 in O.D. x 0.010 in I.D.	5 ft	N9302650
1/16 in O.D. x 0.004 in I.D. (Black)	50 cm	N2916200
1/16 in O.D. x 0.005 in I.D. (Red)	50 cm	N2916059
Connector Tubing, Flexar/FX Mixer to Injector, SS		N2916211
Connector Tubing, Flexar ISO/Binary/Quaternary Pump to Autosampler, SS		N2916210

Stainless Steel Tubing

Features and Benefits

- Pre-cut and mirror-polished in 316 stainless steel

SS-316 Tubing

Description	Size	Part No.
1/16 in. o.d. x .043 in. i.d.	6 ft	00873035
1/16 in. o.d. x .015 in. i.d.	6 ft	00873036
1/16 in. o.d. x .007 in. i.d.	3 ft	02540838
1/16 in. o.d. x .007 in. i.d.	20 cm	02711441
1/16 in. o.d. x .007 in. i.d.	50 cm	00891480

Tefzel Tubing

Description	Size	Part No.
1/16 in. o.d. x .030 in. i.d.	10 ft	N9301029

High-performance Fingertight® fittings for the most demanding applications

This PEEK Fingertight® fitting is the toughest with regard to chemical resistance and pressure. This high-performance Fingertight® fitting is recommended for the most demanding applications and will resist pressures up to 6,000 psi (400 bar). Made from a single piece of PEEK, the size permits tightening without tools.

Description	Part No.
PEEK One-Piece Fingertight® Fitting	ED020005

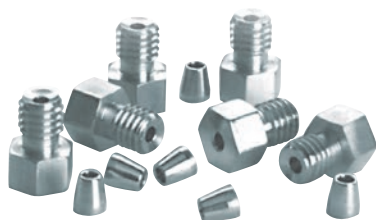

Fittings, Nuts and Ferrules

Stainless steel nuts are available in both Parker-Hannifin and Rheodyne™ formats. The nuts are used to connect 1/16 inch o.d. stainless steel tubing and feature a 10-32 thread size. PerkinElmer also offers select SSI fittings for 1/16 inch o.d. tubing in 1/4-28 thread size.

Stainless Steel Fittings

Description	Part No.
Kel-F Reverse Ferrule, 1/8 inch*	09903771
Kel-F Ferrule, 1/16 inch*	09920382
Tefzel Nut, 1/16 inch*	09920381
Parker-Hannifin Ferrule, 1/16 inch	00873032
Parker-Hannifin Nut, 1/16 inch	09903980
Parker-Hannifin Nut & Ferrule Kit, 1/16 inch Includes: 6 nuts and 6 ferrules	00890945
Parker-Hannifin Zero-Dead-Volume Union with nuts and ferrules	09903289
Parker-Hannifin Medium-Stem SS Nut	N2916202
Rheodyne™ Ferrule, 1/16 inch	09904947
Rheodyne™ Nut, 1/16 inch long body	09904974
Rheodyne™ Nut, 1/16 inch short body	09904956
Rheodyne™ Nut and Ferrule Kit, 1/16 inch Includes: 6 ferrules, 3 short nuts and 3 long nuts	02540274
Tefzel Nut (for Reverse Ferrule), 1/8 inch*	N2601189
Tefzel Nut, 1/16 inch*	09920381
Valco Ferrule	09903891
OptiTech Reusable Nut/Ferrule for UHPLC (fingertight to 15K psi)	N9306301
OptiTech Ferrule replacements for UHPLC (10 pack)	N9306300
UHPLC 1/16 inch Reusable Fitting	N9307800

* The Tefzel and Kel-F fittings above are only for low pressure use (under 400 psi).

ONE-PIECE, EASY-TO-USE



Fittings Kits

Recommended for users of a PerkinElmer Biocompatible LC system. Contains nuts, ferrules and unions.

Description	Part No.
Biocompatible Column Fittings for LC	N9301001

Fittings Kit for LC

The kit contains Rheodyne™ and SSI nuts and ferrules as well as Fingertight® II nuts and ferrules for toolless installation. Zero-dead-volume unions are also included. In addition, you receive varying lengths of stainless steel tubing in 0.007 and 0.010 inch i.d., as well as 0.30 inch i.d Tefzel® tubing.

Description	Part No.
All-in-one Fittings Kit	N9301002

Operation Kit

Recommended for purchasers of their first LC. Includes tubing, union, fittings, syringe, basic LC book and test mix.

Description	Part No.
Operation Kit	00890873



Flom Analytical Injection Valve

The Flom Analytical Injection Valve is a very reliable manual HPLC injection valve. It comes with a built in “Inject” contact closure connection output. A PEEK rotor seal is provided for excellent solvent/sample resistance and the fluid path is designed for minimal dispersion. This valve is available in either stainless steel or PEEK, depending on the application or need.

Description	Part No.
Flom Injection Valve Stainless Steel	N9306073
Flom Injection Valve PEEK	N9306072

Injector Valve Rotor Seals

For both Series 200 Autosampler and manual injectors.

For both the Rheodyne and Flom valves, rotor seals should be periodically replaced every 6 months to a year and are available in PEEK. For the Rheodyne valve, they are also available in Vespel. PEEK is more inert towards amines and other basic biomolecules/ pharmaceuticals, exhibiting less sample carryover. However, Vespel is somewhat more resilient than PEEK, providing somewhat better wear life.

Description	Part No.
Flom Rotor Seal PEEK	N9306068
Rheodyne 7725 Vespel Rotor Seal	09904802
Rheodyne 8125 Vespel Rotor Seal	10070900
Rheodyne 7725/9725 PEEK Rotor Seal	N9306044



Rheodyne™ 9725 PEEK Bio Injection Valve

Model 9725 is inert and well-suited to the chromatography of biological molecules, including applications with aggressive mobile phases. This valve is useful in all applications in which metal contact with the mobile phase and or sample should be avoided. This valve uses PEEK vent lines and a PTFE rotor seal and can be operated in a pH range from 0 – 14.

Description	Part No.
9725 Injection Valve for Series 200 Autosampler	N9306020

Rheodyne™ 8125 Low-Dispersion Stainless Steel Injection Valve

Ideal for use in an LC/MS system, the model 8125 is designed for 1 and 2 mm microbore columns and can also be used with conventional analytical (3 to 5 mm) columns. Small flow passages produce low dispersion, maintaining the high mass sensitivity inherent in micro columns.

Description	Part No.
8125 Low-Dispersion Stainless Steel Injection Valve	N9306021

Rheodyne™ 7725 Analytical Injection Valve

Inject from 1 µL to 5 mL with high accuracy and precision, with the Rheodyne™ 7725 and 7725i valves.

Rheodyne™ 7725 and 7725i valves are versatile injectors and can use both partial-filling and complete-filling methods for loading the sample loop. Wide port angles of the 7725/7725i valve provide improved access to fittings. Sample loop with a 2 µL internal capacity is also available. In a clean system, the 7725/7725i typically can make more than 30,000 injections before requiring replacement of the rotor seal.

Description	Part No.
7725 Injection Valve for Series 200 Autosampler	N9306019
7725i Injection Valve with Internal Switch	N9306017

INJECT WITH GREATER PRECISION

Flexar Autosamplers

Best-in-class cycle time. Wide injection volume range. Excellent injection reproducibility. Precisely what you need to increase your sample throughput and efficiency.



Features and Benefits

- Injects sample volumes as little as 1 µL at pressures up to 18,000 psi with the FX UHPLC Autosampler
- Loads sample in only 8 seconds (in partial fill mode)
- Three injection modes: full loop, partial fill and µL-pickup with no sample waste
- Peltier cooling/heating mode option for operation at 4 °C to 40 °C. Will reach 4 °C ± 2 °C, achievable even at ambient temperatures up to 25 °C

All Flexar autosamplers can be upgraded in the field for Peltier cooling and heating. All Flexar autosamplers include:

- 100-sample tray
- 100 2 mL vials
- 100 2 mL screw top cap with cross slit vial septum
- Tubing to connect to waste reservoir
- I/O cable (Pump Start/Ready-In)
- Service Manager SW CD
- User's Manual
- Nuts and ferrules
- All fuses for 120–240 V
- All cables required for connection to a TotalChrom or Chromera Operating Environment

Flexar Autosamplers and Upgrade Kits

Description	Part No.
Flexar LC Autosampler	
High throughput autosampler with exceptionally low carryover. Operates up to 6,100 psi (420 bar). Provides flexible injection modes: full-loop, partial-fill and µL-Pickup (no sample waste). Peltier cooling and heating options available as field upgrades. Comes standard with 100 µL loop and 250 µL sample flush syringe.	N2930660
Flexar Peltier LC Autosampler	
High throughput autosampler with exceptionally low carryover. Operates up to 6,100 psi (420 bar). Provides flexible injection modes: full-loop, partial-fill and µL-Pickup (no sample waste). Built-in Peltier cooling comes standard. Peltier heating option available as field upgrade. Comes standard with 100 µL loop and 250 µL sample flush syringe.	N2930661
Flexar FX UHPLC Autosampler	
High throughput UHPLC autosampler with exceptionally low carryover. Operates up to 18,000 psi (1,241 bar). Provides flexible injection modes: full-loop, partial-fill and µL-Pickup (no sample waste). Built-in Peltier cooling comes standard. Peltier heating option available as field upgrade. Comes standard with 10 µL loop and 250 µL sample flush syringe.	N2930664
Field Upgrade Peltier Kits	
Flexar and Series 225 Upgrade Kit (from standard to Peltier Cooling option)	N2930672
Flexar and Series 225 Upgrade Kit (from standard to Peltier Cooling and Heating option)	N2930673
Flexar and Series 225 Upgrade Kit (from Peltier Cooling to Peltier Cooling and Heating option)	N2930669

Flexar or Series 225/275 Autosampler Trays and Accessories

Description	Part No.
25-Position 6 mL Vial Sample Tray	N2936045
80-Position 2 mL Vial plus (5) 6 mL Vial Tray (for derivatization)	N2936046
80-Position 2 mL Vial Tray with Dilution Tray	N2930676
96-well Microtiter Adapter	N9302562
96-well 'Deep-well' Microtiter Adapter	N9302560
96-well 7 mm Pre-slit Silicone Plate Mat/Seal	N9302555
96-well 'Deep' Microtiter Plate Adaptor (Supports Dual Microtiter Plates)	N2936048
96-well 'Shallow' Microtiter Plate Adaptor (Supports Dual Microtiter Plates)	N2936049
384-well Microtiter Adapter	N2936050
100-Position 2 mL Vial Sample Tray	N2936042
(200) 0.2 mL Microvial plus (5) 2 mL Vial Tray	N2936043
250 µL Syringe Tip Replacements (10/pkg)	N2936003
Flexar/225 Biocompatible Upgrade Kit (w/valve)	N2930675
1/16" OD x 0.038" ID PTFE Tubing (AS Transfer Line)	02506495

Flexar Autosampler Valve Maintenance Parts

Description	Flexar LC (6000 psi)	Flexar UHPLC (18000 psi)
	Part No.	Part No.
Rotor Seal	N2936021	N2932001
Stator	N2936022	N2932002

	Part No.
NEW Flexar UHPLC (18000 psi) Autosampler Valve Upgrade Kit	N2932000
Flexar Analytical LC (6000 psi) Autosampler Valve	N2936020

High Pressure Analytical Static Mixers

Static Mixers are important in facilitating complete mobile phase blending, resulting in improved retention performance. These mixers should be used as part of FX10, or FX15 LC systems, where high pressure blending is required. Mixers incorporate a highly efficient cross-flow shearing mechanism which produces vortex shear mixing over a wide range of volumes. They are now offered in 18,000 psi pressure max flavor.

A good first choice selection is a volume of about half the flow rate volume. For example, when pumping at a 0.5 mL/min flow rate, a 350 µL mixer provides good mixing with very good baseline stability.

Description	Part No.
50 µL In-Line High Pressure Mixer Assembly, SS	N2911200
150 µL In-Line High Pressure Mixer Assembly, SS	N2911201
250 µL In-Line High Pressure Mixer Assembly, SS	N2911202
350 µL In-Line High Pressure Mixer Assembly, SS	N2911205
500 µL In-Line High Pressure Mixer Assembly, SS	N2911203
150 µL High Pressure Binary High Pressure Mixing-T, SS	N2911206
10 µL Binary Mixing-T, SS	N2911170
Binary High Pressure T-Mixer, SS, 50 µL	N2911212
Binary High Pressure T-Mixer, SS, 350 µL	N2911210
Binary High Pressure T-Mixer, SS, 500 µL	N2911211
T-connector, SS	N2911127

Syringes and Kits

PerkinElmer syringe kits for high pressure applications are manufactured for precise liquid delivery. All of these glass syringes come with precision stainless steel plungers. They are used for sampling and flushing and are available in a large variety of sizes.

Syringes

Description	Part No.
Sample Needle w/Fittings	N2936009
Air Guide Needle (62 mm)	N2936000
Bio Compatible Sample Needle w/Tubing Connector	N2936010
Needle (80 mm)	N2936342
Blunt Tip/Low Volume Needle	N2931199

Syringe Kits

Dimension	Buffer Tubing	Part No.
100 µL	200 µL	N2936051
250 µL	500 µL	N2936052
500 µL	1,000 µL	N2936053
1,000 µL	2,000 µL	N2936054
2,500 µL	2,000 µL	N2936055

FX-15, FX-20 UHPLC Pump Accessories

Description	Part No.
Replacement 0.5 µm Filter Frits for FX-15 (4-pack)	N2911224
High Pressure FX-15 Piston Seal Kit (Need 4 per FX-15)	N2911221
Piston Wash Bottle Kit	N2601616
2,500 µL Sample Syringe Starting Kit	N2930313

FX-10, FX-15 and FX-20 UHPLC System Accessories

Description	Color	Size	Part No.
ID PEEK Tubing			
0.004"	Black	50 cm	N2916200
0.005"	Red	50 cm	N2916056
0.004"	Black	76 cm	N2916260
0.005"	Red	66 cm	N2916262
Connector Tubing, Stainless Steel			
Flexar ISO/Binary/Quaternary Pump to Autosampler			N2916210
Dual Mixer Connection (≤ 250 µL)			N2916216
Dual Mixer Connection (≥350 µL)			N2916217
FX-10 Pump A (Upper) to T-mixer			N2916213
FX-10 Pump B (Lower) to T-mixer			N2916214
FX-10 Purge Valve to Filter/Scavenger			N2916212
FX-10 Injector to Column			N2916215
FX-10 Pump A (Upper) to Dual Mixers			N2916218
FX-10 Pump B (Lower) to Dual Mixers			N2916219
FX-15 Pump to In-line Mixer			N2916222
FX-15 Pump to Dual Mixers			N2916224
FX-15 Injector to Column, Standard			N2916223
FX-15 Injector to Column, 33 cm			N2916201
3 cm Scavenger Cartridge Holder			02580178
Spheri5 Scavenger Columns (5-pack)			02580202
30 mL Priming Syringe			09904849
FX-15 C18 Scavenger Column Kit			N2910765
FX-15 C18 Scavenger Columns (2/pkg)			02580223

Microsyringes (For Manual Injection)

Syringes are used for accurate and precise liquid delivery. Each syringe is hand-fitted to assure maximum accuracy. Our syringes are composed of glass barrels and precision stainless steel needles. The needle features a blunt tip, required for use with a Rheodyne injector.

Description	Part No.
10 µL Syringe	09904937
25 µL Syringe	09904823
50 µL Syringe	09904941
100 µL Syringe	09904822
Rheodyne 22-gauge Blunt Needle with Luer Hub	09904943

Rheodyne Valves Spare Parts

	Description	Model 9725 Part No.	Model 7725 Part No.
1	Handle Screw		
2	Handle		
3	Knob Assembly		
4	Set Screws		
5	Needle Guide S200 Autosampler	N2931054	N2931054
	Manual Valve ISS-100	09904800	09904800
6	Body		
7	Thrust Bearing		
8	Rotor Pin		
9	Seal Pins		
10	Needle Port Tube	09904805	09904805
11	Bearing Ring		
12	Isolation Seal		
13	Rotor Seal Vespel	09904802	09904802
	Tefzel	N9302677	N9302677
	PEEK	N9306044	N9306044
14	Stator Ring		
15	Stator Face Assembly PEEK and Ceramic	N9306047	N9306047
16	Set Screws		
17	Stator PEEK	N9306046	
	Stainless Steel Titanium		N9306045
18	Stator Screws		

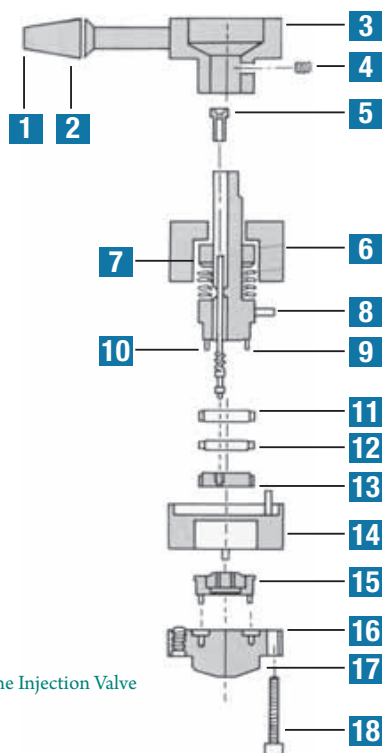

Rheodyne Injection Valve

PEEK Sample Loops for Rheodyne Valves

PEEK Sample Loops avoid many of the problems associated with stainless steel sample loops. Metal loops will often absorb sample components resulting in inaccurate quantitative results. In addition, metal loops may be corroded by high-salt buffers and chloride salts. Sample Loops are made from PEEK tubing and fittings. PEEK (Poly-Ether-Ether-Ketone) is a mechanically strong, chemically inert polymer ideal for HPLC applications where metal surfaces may interact with mobile phase or sample components.



Sample Loops

Each Sample Loop is supplied with two PEEK hex-head nuts and ferrules. These fittings grip the tubing in two locations for a more reliable connection.

Description	Model 9725 Part No.
5 µL PEEK Sample Loop	N9306033
10 µL PEEK Sample Loop	N9306034
20 µL PEEK Sample Loop	N9306035
50 µL PEEK Sample Loop	N9306036
100 µL PEEK Sample Loop	N9306037
200 µL PEEK Sample Loop	N9306038
500 µL PEEK Sample Loop	N9306039
1 mL PEEK Sample Loop	N9306040
2 mL PEEK Sample Loop	N9306041
5 mL PEEK Sample Loop	N9306042

SS Loop for model 7725

Description	Model 7725 Part No.
5 µL Stainless Steel Sample Loop	N9306023
10 µL Stainless Steel Sample Loop	N9306024
20 µL Stainless Steel Sample Loop	N9306025
50 µL Stainless Steel Sample Loop	N9306026
100 µL Stainless Steel Sample Loop	N9306027
200 µL Stainless Steel Sample Loop	N9306028
500 µL Stainless Steel Sample Loop	N9306029
1 mL Stainless Steel Sample Loop	N9306030
2 mL Stainless Steel Sample Loop	N9306031
5 mL Stainless Steel Sample Loop	N9306032

Note: Loops are compatible with both manual valves and Series 200 Autosampler valves.

Internal Loop for Models 7725/9725

Description	Part No.
2 µL (PEEK and Ceramic)	N9306022

Peltier Tray Accessories

100-Position Peltier Temperature-Controlled Tray Accessory

100 standard 2 mL vials. Temperature controlled from 4 - 60 °C within ± 1 °C directly from Autosampler keypad – or from TotalChrom Workstation – Client/Server.

Description	Part No.
100-Position Peltier Temperature-Controlled Tray Accessory	N2930035



Double Microtiter Peltier Temperature-Controlled Tray Accessory

Two shallow or medium depth microtiter plates. Temperature controlled from 4 - 60 °C within ± 1 °C directly from Autosampler keypad – or from TotalChrom Workstation – Client/Server. (Also requires N2930036).

Description	Part No.
Double Microtiter Peltier Temperature-Controlled Tray Accessory	N2930037

Peltier Temperature Controller

Controller Unit required for operation of either 100-position or Double Microtiter Peltier trays.

Description	Part No.
Peltier Temperature Controller	N2930036

Series 200 Autosampler Microtiter Trays and Plates

If you need high throughput and high speed, the Series 200 is designed for injecting up to 225 samples at rates as fast as two to three injections per minute from any sample position – ideal for LC/MS work. The Series 200 even supports direct injections from microtiter plates – shallow or deepwell format.

Tray Description	Part No.
Double Deep Microtiter Tray (Holds two 96-well Plates)	N2930147
Double Microtiter Peltier Tray Requires Peltier Controller (N2930036) (Holds two 96-well Plates)	N2930037
Double Shallow Microtiter Plate Tray (Holds two 96-well Plates)	N2930146
Peltier Tray for 384-well Microtiter Plates Requires Peltier Controller (N2930036) and Series 200 Autosampler Firmware 1.08 or higher.	N2930038



Description	Part No.
100-Position Peltier Temperature-Controlled Tray Accessory	N2930035

Sample Trays

PerkinElmer has researched, engineered, and developed the Series 200 Autosampler to ensure precision, flexibility, reliability, and ease-of-use.

Our unique XYZ design allows you to take advantage of the built-in “extra” capabilities including dilution, derivatization, and standard addition – all without additional hardware or cost.

Description	Part No.
25-Position Sample Tray	N2930040
80-Position Sample Tray, Dilution (with tank)	N2930314
Includes: 80-Position Tray Only	N2930044
Glass Diluent Tank Only	B0505677
85-Position Sample Tray, Derivatization	N2930041
100-Position Sample Tray	N2931097
205-Position Sample Tray, Microvials/10 standard vials	N2930042
225-Position Sample Tray, Microvials/high throughput	N2930043

Microtiter Plates Description	Part No.
96-well Deep (1mL)	N9302560
96-well Plate Cover/Mat	N9302563
96-well Shallow (200 μ L)	N9302562
96-well Mid (500 μ L)	N9302561
96-well Plate Cover/Mat	N9302563
96-well Shallow (200 μ L)	N9302562
96-well Mid (500 μ L)	N9302561
96-well Plate Cover/Mat	N9302563
384-well Plate (200 μ L)	N9302564
384-well Plate Cover/Mat	N9302565

SUPPLIES AND ACCESSORIES

UHPLC – General Starter Kit

Description		Part No.
UHPLC – General Starter Kit		N2930801
Contents	Qty/Pack	Part No.
Open-End Wrench	2	09907233
Adjustable Wrench	1	N9301326
Reversible Screw Driver	1	N9301480
Parker-Hannifin ZDV SS Union	1	09903289
Parker-Hannifin Medium-Stem SS Nuts	10	09903980
1/16" Parker-Hannifin SS Ferrules	10	00873032
1/16" Valco SS Ferrules	6	09903891
Finger-Tight Fittings, PEEK, 5.5K psi Max. (5/pk)	1	N9307822
Optimize Technologies EZP (Hand-Tight Fitting to 13K psi, Wrench-tight to 20K psi)	1	N9306301
1/16" Tefzel Nuts	2	09920381
1/16" Tefzel Reverse Ferrules	2	09920382
1/8" Tefzel Nuts	4	N2601189
1/8" Tefzel Reverse Ferrules	4	09903771
PEEK Tubing Cutter (Includes 5 Extra Blades)	1	N9307820
50 cm x 0.005" ID 1/16" SS Tubing	3	02507060
5' x 0.004" ID 1/16" PEEK Tubing, Black	1	N2916261
5' x 0.005" ID 1/16" PEEK Tubing, Red	1	N2916262
30 mL Priming Syringe	1	09904849
2 mL Clear Write-On Vials w/10 mm Pre-Slit PTFE/Silicone Caps; 100/pk	1	N9300695
Cable/Tubing Organizer Clip	3	NX598006

HPLC – General Starter Kit

Description		Part No.
HPLC – General Starter Kit		N2930802
Contents	Qty/Pack	Part No.
Open-End Wrench	2	09907233
Adjustable Wrench	1	N9301326
Reversible Screw Driver	1	N9301480
Parker-Hannifin ZDV SS Union	1	09903289
Parker-Hannifin Medium-Stem SS Nut	10	09903980
1/16" Parker-Hannifin SS Ferrule	10	00873032
1/16" Valco SS Ferrules	6	09903891
Rheodyne SS Nut, Short Stem	2	09904956
Rheodyne SS Nut, Long Stem	2	09904974
1/16" Rheodyne SS Ferrule	4	09904947
1/16" Tefzel Nuts	2	09920381
1/16" Tefzel Reverse Ferrules	2	09920382
1/8" Tefzel Nuts	4	N2601189
1/8" Tefzel Reverse Ferrules	4	09903771
Finger-Tight Fittings, PEEK, 4K psi Max.	6	09920513
PEEK Tubing Cutter (Includes 5 Extra Blades)	1	N9307820
50 cm x 0.005" ID 1/16" SS Tubing	1	02507060
50 cm x 0.007" ID 1/16" SS Tubing	2	00891480
5' x 0.007" ID 1/16" PEEK Tubing, Yellowish-Tan	1	N9302650
5' x 0.005" ID 1/16" PEEK Tubing, Red	1	N2916262
30 mL Priming Syringe	1	09904849
2 mL clear write-on vials w/10 mm Pre-Slit PTFE/Silicone Caps; 100/pk	1	N9300695
Cable/Tubing Organizer Clip	3	NX598006

Autosampler Syringes

Description	Pkg.	Part No.
Sampling Syringe	50 µL	09923304
Sampling Syringe	100 µL	09923305
Sampling Syringe	250 µL	09923270
Sampling Syringe	500 µL	09923306
Sampling Syringe	1000 µL	09923307
Sampling Syringe	2500 µL	09923219*
Sampling Syringe Kit 2500 µL (includes 2500 µL syringe, union and tubing kit)	2500 µL	N2930313
Flush Syringe	2500 µL	09923219

*Requires one-time purchase of N2930313



EVO N₂ Nitrogen Generators

Technical Specifications for EVO N₂ Nitrogen Models

Description	Specification
Purity	> 98% (less 2% O ₂)
Outlet Pressure	8 bar / 120 psi
Height	64.1 cm (25.2 in)
Width	48.2 cm (19 in)
Depth	83.5 cm (32.9 in)
Weight	121 kg (266 lbs)
Operating Temperature	+10 °C to +40 °C (+50 °F to +104 °F)
Operating Relative Humidity	0 – 80 % rF, no condense / 0 – 99% rF with condense drain
Power Consumption	1300 Watt
Circuit Breaker	10A for 230V ; 15A for 110V
Heat Dissipation	Approx 2700 Btu/h

Flow Rate	Voltage	Part No.
25 L/min	115V	N9308587
	220V	N9308573
35 L/min	115V	N9308588
	220V	N9308574
60 L/min	115V	N9308589
	220V	N9308575



EVO N₂ Hybrid Nitrogen Generators

The EVO Nitrogen hybrid gas generators was specifically designed to meet the flow, purity and pressure requirements of the LC/MS of AB SCIEX with appropriate pressures and flows of nitrogen. The simple and proven pressure swing adsorption (PSA) technology is employed to remove Nitrogen from compressed air. Selective molsieves (CMS) adsorb remaining Oxygen and traces of humidity.

Technical Specifications for EVO N₂ Hybrid Nitrogen Models

Description	Specification
Purity	> 99.5% (less 2% O ₂)
Outlet Pressure	8 bar / 120 psi
Height	64.1 cm (25.2 in)
Width	48.2 cm (19 in)
Depth	83.5 cm (32.9 in)
Weight	121 kg (266 lbs)
Operating Temperature	+10 °C to +40 °C (+50 °F to +104 °F)
Operating Relative Humidity	0 – 80 % rF, no condense / 0 – 99% rF with condense drain
Power Consumption	1300 Watt
Circuit Breaker	10A for 230V ; 15A for 110V
Heat Dissipation Approx	2700 Btu/h

Flow Rate	Voltage	Part No.
Up to 10 L/min +/- 1.5 L/min (at atmospheric pressure)	115V	N9308590
	220V	N9308576

N₂ Whisper Generators

The Whisper nitrogen generator has been developed to meet specific requirements in terms of flow, purity and pressure in LC/MS applications. It can also be used for the evaporation of solvents in samples being analyzed. The simple high efficiency membrane technology allows nitrogen separation from other air components present within the supplied compressed air.

Better results from analytical instruments: The constant purity of nitrogen improves system stability and ensures reproducible results.

Better lab efficiency: Gas cylinders are insufficient to ensure the large nitrogen volumes needed in LC/MS techniques.

Cost savings: Initial investment can normally be paid back in less than a year. No plumbing is required to transfer gas from the storeroom to the lab.

Improved safety: Nitrogen produced at low pressure and room temperature eliminates the risks related to high pressure gas bottle use and the hazards associated with liquid nitrogen.

Simple installation: The Whisper nitrogen generator is very easy to install. Simply plug the unit into a 200V 60Hz/50Hz outlet. The exclusive "Split System" design allows the section containing the compressor to be installed separately from the nitrogen production assembly, which can be wall-mounted to save precious space!

Technical Specifications

Description	Specification
Purity (based on outlet flow)	> 98 - 99.5%
Outlet Pressure	7 bar
Height	115 cm (45.3 in)
Width	48 cm (19 in)
Depth	26 cm (10.2 in)
Weight	15 kg (33 lbs) ; 18 kg (39 lbs); 21 kg (46 lbs)
Operating Temperature	+10 °C to +35 °C (+50 °F to +95 °F)
Air Compressor Supplied	NO
Electrical Requirements	None
Background Noise	None
Connections	1/4 G

Flow Rate	Part No.
40 L/min	N9306285
80 L/min	N9306286
120 L/min	N9306287



N₂ Mini Whisper Generators

The Mini Whisper Nitrogen generator has been developed to meet specific requirements in terms of flow, purity and pressure on some LC/MS interfaces as well as on light scattering evaporative detector.

The simple high efficiency membrane technology allows the separation of Nitrogen from the other components of the compressed air inlet.

The low pressure drop allows the unit to be connected to an existing dry and oil-free compressed air source in the lab.

Technical Specifications

Description	Specification
Purity (based on outlet flow)	> 98 - 99.5%
Outlet Pressure	7 bar
Height	73.5 cm (28.9 in)
Width	34.8 cm (13.7 in)
Depth	35 cm (13.8 in)
Weight	8 kg (18 lbs)
Operating Temperature	+10 °C to +35 °C (+50 °F to +95 °F)
Air Compressor Supplied	NO
Electrical Requirements	None
Background Noise	None
Connections	1/4 G

Flow Rate	Part No.
8 L/min	N9306288

Parker Domnick Hunter Nitrogen Generators

PerkinElmer offers customers a new line of nitrogen generators to meet the growing need for cost effective and pure nitrogen. Membrane Nitrogen Generators are designed to supply single or multiple LC/MS instruments with dry nitrogen at purities of 98% to 99.5%. The generator can also be used for solvent evaporation as well as supplying dry nitrogen to analytical instruments.

Nitrogen is produced by utilizing a combination of filtration and membrane separation technologies. A high efficiency pre-filtration system pre-treats the compressed air to remove all contaminants down to 0.01 micron. Hollow fiber membranes subsequently separate the clean air into a concentrated nitrogen output stream and an oxygen enriched permeate stream, which is vented from the system. The combination of these technologies produces a continuous on demand supply of pure nitrogen.



Technical Specifications

Description	Low Flow NitroFlow Lab	N2-22 Mid Flow	N2-35 Mid Flow	N2-45 High Flow
Purity	94.0 - 99.5%	95.0 - 99.5%	95.0 - 99.5%	95.0 - 99.5%
Min./Max. Operating Pressure	8 bar	60/145 psig (4.0/10 barg)	60/145 psig (4.0/10 barg)	60/145 psig (4.0/10 barg)
Height	70 cm (27.6 in)	13 cm (5.1 in)	13 cm (5.1 in)	140 cm (55.1 in)
Width	90 cm (35.4 in)	45 cm (17.8 in)	45 cm (17.8 in)	61 cm (24.0 in)
Depth	31 cm (12.2 in)	41 cm (16.1 in)	41 cm (16.1 in)	50 cm (20.0 in)
Weight	127.4 kg (280 lbs)	36 kg (80 lbs)	41 kg (90 lbs)	114 kg (250 lbs)
Operating Temperature	+10 °C to +35 °C (+50 °F to +95 °F)	+15 °C to +35 °C (+60 °F to +95 °F)	+15 °C to +35 °C (+60 °F to +95 °F)	+15 °C to +35 °C (+60 °F to +95 °F)
Electrical Requirements	120 V / 60 Hz, 20 Amp Nema 5	None	None	None
Air Compressor	Yes	No	No	No
Flow Rates	10 - 50 lpm	100 psi inlet - 13 lpm output - 99.5% purity 125 psi inlet - 16 lpm output - 99.5% purity	100 psi inlet - 20 lpm output - 99.5% purity 125 psi inlet - 25 lpm output - 99.5% purity	100 psi inlet - 39 lpm output - 99.5% purity 125 psi inlet - 55 lpm output - 99.5% purity
		100 psi inlet - 20 lpm output - 99.0% purity	100 psi inlet - 30 lpm output - 99.0% purity	100 psi inlet - 53 lpm output - 99.0% purity
		125 psi inlet - 25 lpm output - 99.0% purity	125 psi inlet - 37 lpm output - 99.0% purity	125 psi inlet - 74 lpm output - 99.0% purity
		100 psi inlet - 30 lpm output - 98.0% purity	100 psi inlet - 45 lpm output - 98.0% purity	100 psi inlet - 73 lpm output - 98.0% purity
		125 psi inlet - 38 lpm output - 98.0% purity	125 psi inlet - 57 lpm output - 98.0% purity	125 psi inlet - 106 lpm output - 98.0% purity
Part No.	N9306213 (120V) N9306214 (230V)	N9306210	N9306211	N9306212

LC/MS Nitrogen Generators with Integrated Compressors

Description	Specification
Purity	>98%
Min. / Max. Operating Pressure	101.5 psi/g
Height	70.1 cm (27.8 in)
Width	51.1 cm (20.1 in)
Depth	58.2 cm (22.9 in)
Weight	135.2 kg (298 lbs)

Description	Specification
Operating Temperature	+5 °C to +40 °C (+41 °F to +104 °F)
Port Connection Outlet	1/4" Compression Fitting
Electrical Requirements	120 V / 60 Hz or 230 V / 50-60 Hz ± 10%
Air Compressor	Yes
Flow Rates	30 L/min
Part No.	N9303223 (120V) ; N9303224 (230V)

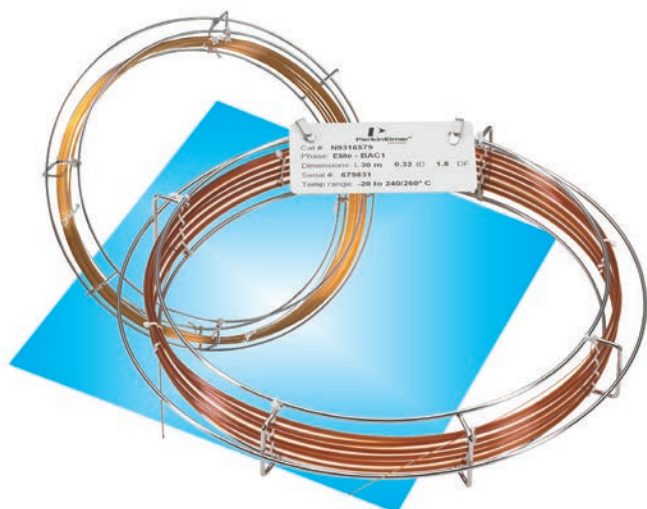

FINEST QUALITY HIGH-STRENGTH FUSED SILICA

Why choose fused silica?

Many factors influence the quality of a column. Fused silica is considered to be the purest form of glass, with fewer metal oxides (Lewis acid sites) and hydrogen bonding (surface silanol) groups. The stationary phase is cross linked (polymerized) and also bonded to the surface of the column to provide a high degree of stability, resulting in lower bleeding of the stationary phase at elevated temperatures. The superior inertness of the column means that acidic and basic compounds can be analyzed on the same column.

Selecting the right Stationary Phase

The inherent efficiency (large number of theoretical plates) of capillary columns allows you to choose from relatively few types of phases, compared to the many varieties of packed columns previously required. Perhaps more importantly, because capillary columns are more efficient, you will see superior resolution resulting in narrower, taller peaks that allow easier integration from your data system. Identification of small peaks are facilitated by a reduced baseline bleed and lower baseline noise. Non-polar Elite-1 columns from PerkinElmer will preferentially retain non-polar compounds, whereas the PerkinElmer Elite-200 column phase provides high selectivity for analytes containing lone pair electrons, such as nitro and carbonyl groups. Elite-WAX polyethylene glycol columns are highly selective toward polar compounds such as alcohols.

What length do I need?

Typically capillary columns are available in lengths from 15 to 105 meters. The longer the column the more resolving power, but this also increases the analysis time. Doubling a column length only increases resolution by approximately 40%. Under isothermal conditions, the analysis time will double if using temperature programmed analysis retention times are more dependent on the temperature than on the column length. PerkinElmer provides columns in the most popular lengths of 5, 10, 12, 15, 25, 30, 50, 60, 75, 100 and 105 meters depending upon the column i.d.

Quick Phase Cross Reference Chart*

Phase/Description	Equivalent Capillary Phase
Elite-1, Elite-1ht 100% Dimethyl	DB-1, DB-1ht, HP-1, HP-101, Ultra-1, SPB-1, CP-Sil 5CB, CI-Sil5CBMS. RSL-150, RSL-160, Rtx-1, BP-1, CB-1, OV-1, 007-1MS, SP-2100, SE-30
Elite-200 Trifluoropropylmethyl	DB-210, AT-210, VF-200MS, 007-210, Rtx-200
Elite-5, Elite 5ms, Elite -5ht 5% Diphenyl – 95% Dimethyl	DB-5, DB-5ms, DB-5ht, Ultra-2, SPB-5, CP-Sil8CB, RSL-200. Rtx-5, BP-5, CB-5, OV-5, 007-2(MPS-5), SE-52, SE-54, XTI-5. Rtx-5ms, PTE-5, HP-5ms
Elite-5Amine 5% Diphenyl – 95% Dimethyl Polysiloxane	PTA-5
Elite-35, Elite-35ms 35% Phenyl – 65% Methyl	DB-35, DB-35ms, Rtx-35, SPB-35, AT-35, Sup-Herb
Elite-17, Elite-17ms, Elite-17ht 50% Phenyl – 50% Methyl	DB-17, DB-17ht, HP-17, RSL-300, Rtx-50, 007-17(MPS-50), SP-2250, HP-50+
Elite-1301 6% Cyanopropylphenyl	DB-1301, Rtx-1301, CP-624
Elite-1701 14% Cyanopropylphenyl – 86% Dimethyl	DB-1701, SPB-7, CP-Sil 19CB, Rtx-1701, BP-10, CB-1701, OV-1701, 007-1701
Elite-225 50% Cyanopropylphenyl – 50% Phenyl methyl	DB-225, HP-225, SP-2330, CP-Sil 43CB, RSL-500, Rtx-225, BP-225, CB-225, OV-225, 007-225
Elite-WAX Polyethylene Glycol	DB-FFAP, HP-20M, SUPELCOWAX 10, CP-WAX 52CB, SUPEROX II, CB-WAX, STABILWAX, BP-20, Elite-CW 007-CW, Carbowax, HP-Innowax
Elite-FFAP Polyethylene Glycol – Acid Modified	DB-WAX, HP-FFAP, NukoI, SUPEROX FA, STABI LWAX-DA, 007-FFAP, OV-351, DB-FFAP
Elite-608 Specialty phase for semi-volatile pesticides (EPA 608)	SPB-608, NON_PAKD Pesticide, DB-608, 007-608, HP-608
Elite-624, Elite-Volatiles Volatiles, Specialty phase for volatiles	DB-624, DB_VRX, VOCOL, NONPAKD AT-624, Rtx-Rtx-502.2, 007-624, HP-624, CP-624, Rtx-624
Elite-CLPesticides Specialty Phase for Chlorinated Pesticides	Rtx-CLPesticides
Elite-VMS Specialty Phase for Volatile Organics on GC/MS	Rtx-VMS
Elite-PONA Dimethyl polysiloxane processed for the detailed analysis of petroleum naphtha	DB-Petro100, Petrocol DH, HP-PONA, SPB-1, 007-1, Rtx-1PONA

* For a more detailed cross reference chart, see page 174-175.

PROTECTION WITHOUT THE CONNECTION

Innovative Integrated Guard Columns

Integrated Guard columns: guard columns WITHOUT connections — protecting your analytical column has never been this easy!

Features and Benefits

- No leaks for a more robust method
- No column connections for easier, faster maintenance
- No peak distortions due to connector dead volume and thermal capacity

For analysts who find it inconvenient to make a leak-free connection between the guard column and the analytical column, we offer Integrated Guard columns. These innovative columns incorporate both guard column and analytical column in a continuous length of tubing, eliminating the connection and all connection-associated problems! The guard column section is marked separately from the analytical column, using high-temperature string.

The Integrated Guard column is so economical that we challenge you to compare our price against that of a conventional connection, even if you assemble it yourself.

Elite-1

ID	df (mm)	Temp Limits (°C)	Integra-Guard	30 m Part No.
0.25 mm	0.25	-60 to 330/350	5 m	N9305600
0.53 mm	1.00	-60 to 330/350	5 m	N9305601
	5.00	-60 to 340/360	5 m	N9305602

Elite-5

ID	df (mm)	Temp Limits (°C)	Integra-Guard	30 m Part No.	60 m Part No.
0.25 mm	0.25	-60 to 330/350	5 m	N9305603	
	0.25	-60 to 330/350	10 m	N9305604	
	1.00	-60 to 330/350	5 m	N9305605	
0.32 mm	0.25	-60 to 330/350	5 m	N9305606	N9305607
	1.00	-60 to 330/350	5 m	N9305608	
0.53 mm	5.00	-60 to 340/360	5 m	N9305609	

Elite-5 ms II

ID	df (mm)	Temp Limits (°C)	Integra-Guard	15 m Part No.	30 m Part No.
0.25 mm	0.10	-60 to 330/350	5 m		N9305610
	0.25	-60 to 330/350	5 m	N9305611	N9305612
	0.25	-60 to 330/350	10 m		N9305613
0.50 mm	0.50	-60 to 330/350	5 m		N9305614
	0.50	-60 to 330/350	10 m	N9305615	N9305616
0.32 mm	0.25	-60 to 330/350	5 m		N9305617
	1.00	-60 to 330/350	5 m		N9305618

Elite-5 ms

ID	df (mm)	Temp Limits (°C)	Integra-Guard	30 m Part No.	60 m Part No.
0.25 mm	0.10	-60 to 330/350	5 m		
	0.25	-60 to 330/350	5 m		N9305619
	0.25	-60 to 330/350	10 m	N9305620	N9305621
	0.50	-60 to 330/350	5 m	N9305622	N9305623
	0.50	-60 to 330/350	10 m		N9305624
0.32 mm	0.50	-60 to 330/350	5 m		N9305625
	1.00	-60 to 330/350	5 m		N9305626

Elite-624

ID	df (mm)	Temp Limits (°C)	Integra-Guard	30 m Part No.
0.25 mm	1.40	-60 to 330/350	5 m	N9305627
0.32 mm	1.80	-60 to 330/350	5 m	N9305628
0.53 mm	3.00	-60 to 340/360	5 m	N9305629

Elite-1301

ID	df (mm)	Temp Limits (°C)	Integra-Guard	30 m Part No.
0.53 mm	3.00	-60 to 330/350	5 m	N9305630

Elite-1701

ID	df (mm)	Temp Limits (°C)	Integra-Guard	30 m Part No.
0.25 mm	0.25	-60 to 330/350	5 m	N9305631

Elite-WAX ETR

ID	df (mm)	Temp Limits (°C)	Integra-Guard	30 m Part No.
0.25 mm	0.25	-60 to 330/350	5 m	N9305632
0.32 mm	1.00	-60 to 330/350	5 m	N9305633
0.53 mm	1.00	-60 to 340/360	5 m	N9305634

COLUMN CROSS REFERENCE CHART

Cross Reference Chart by Phase

PerkinElmer	Phase Composition	USP	Agilent®	Alltech®
Elite-1, Elite-M1	dimethyl polysiloxane	G1, G2, G38	HP-1, DB-1, CP-Sil 5 CB	007-1AT-1, EC-1
Elite-1HT	dimethyl polysiloxane		DB-1ht	AT-1ht
Elite-1ms	dimethyl polysiloxane (low bleed)		HP-1, HP-1ms, HP-1msUI, DB-1, DB-1MS, DB-1msUI, Ultra-1, VF-1ms, CP-Sil 5 CB	AT-1ms
Elite-5	diphenyl dimethyl polysiloxane	G27, G36	HP-5, DB-5, CP-Sil 8 CB	EC-5, AT-5
Elite-5HT	diphenyl dimethyl polysiloxane		DB-5ht, VF-5ht	
Elite-5ms	1,4-bis(dimethylsiloxy)phenylene dimethyl polysiloxane		DB-5ms, DB-5msUI, VF-5ms, 8 CG MS	
Elite-5ms II	diphenyl dimethyl polysiloxane		HP-5, HP-5ms, DB-5, Ultra-2, CP-Sil 8 CB	
Elite-17	(low bleed)	G3	DB-17	AT-50
Elite-17ht	phenyl methyl polysiloxane		DB-17ht	
Elite-17ms	phenyl methyl polysiloxane		HP-50+, DB-17, DB-17ht, DB-608, CP Sil 24 CB	
Elite-17ms+	diphenyl dimethyl polysiloxane		DB-17ms, VF-17ms, CP-Sil 24 CB	
Elite-35	Unique Phase	G42	HP-35, DB-35	AT-35, AT-35ms
Elite-35MS	diphenyl dimethyl polysiloxane		DB-35ms, DB35msUI	
Elite-200	Uunique Phase	G6	DB-210, DB-200, VF-200ms	AT-210
Elite-225	trifluoropropylmethyl polysiloxane	G7, G19	DB-225ms, CP Sil 43 CB	AT-225
Elite-624	cyanopropylmethyl phenylmethyl polysiloxane	G43	DB-1301, DB-624, VF-1301ms, VF-624ms, CP-1301	AT-624, AT-1301
Elite-624 MS	Cyanopropylphenyl dimethyl polysiloxane		DB-624, VF-624ms, CP-Select 624 CB	
Elite-1301	Unique phase	G43	DB-1301, DB-624, VF-1301ms, VF-624ms, CP-1301	AT-624, AT-1301
Elite-1701	Cyanopropylphenyl dimethyl polysiloxane	G46	DB-1701R, DB-1701, CP Sil 19 CB, VF-1701ms, VF-1701 Pesticides	AT-1701
Elite-WAX	Cyanopropylphenyl dimethyl polysiloxane	G14, G15, G16, G20, G39	DB-Wax, CP Wax 52 CB	AT-WAXms, EC-WAX
Elite-WAX ETR	Polyethylene glycol	G14, G15, G16, G20, G39	HP-INNOWax, CP Wax 52 CB, VF-WAX MS	AT-WAX

Cross Reference Chart by Application

PerkinElmer	Applications	Agilent®	Alltech®	Machery-Nagel®
Elite-502	Volatile analytes by EPA Method 502.2	DB-502.2		
Elite-608	Semivolatile pesticides by EPA Method 608	DB-608, HP-608		
Elite-VRX	Volatile analytes by EPA Methods 502.2, 601, 602, 8010, 8020	DB-VRX		
Elite-PONA	Detailed analysis of petroleum naphtha	HP-PONA, DB-Petro, CP Sil PONA CB		
Elite-SimDist	Simulated Distillation & Hydrocarbons - ASTM 2887	DB-2887	AT-2887	
Elite-FFAP	Free fatty acids	HP-FFAP, DB-FFAP, VF-DA, CP WAX58 CB, CP-FFAP CB	AT-AquaWax DA, AT-1000	PERMABOND FFAP, OPTIMA FFAP, OPTIMA FFAP Plus
Elite-2560	cis/transFAMES	HP-88		
Elite-2330	cis/trans FAMES & Dioxins	VF-23ms	AT-Silar90	
Elite-XLB	Polychlorinated biphenyl analytes by EPA Methods 8082, 6008, PCB congeners	DB-XLB, VF-XMS		
Elite-VMS	Volatiles Organic Pollutants by GC-MS for EPA Methods 8260,624,524	Unique Phase		
Elite-BAC 1 Advantage	Blood Alcohol Testing	DB-ALC1		
Elite-BAC 2 Advantage		DB-ALC2		
Elite-CLPesticides	Organochlorine pesticides by EPA Methods 505, 508, 608, 8081, 8082	DB-CLP1		
Elite-CLPesticides2		DB-CLP2		

COLUMN CROSS REFERENCE CHART

Machery-Nagel®	Ohio Valley®	Phenomenex®	Quadrex®	Restek®	SGE®	Supelco®
OPTIMA 1	OV-1	ZB-1	007-1	Rtx-1, Mtx-1	BP1	SPB-1
		ZB-1HTInferno		Rxi-1HT		
OPTIMA 1 MS, OPTIMA 1 MS Accent		ZB-1, ZB-1ms	007-1	Rxi-1ms	BP-1	SPB-1, Equity-1
OPTIMA 5	OV-5	ZB-5	007-5	Rtx-5	BP5	SPB-5
OPTIMA 5HT		ZB-5HTInferno		Rxi-5HT	HT5	
OPTIMA 5 MS Accent	OV-5MS	ZB-5msi	007-5MS	Rxi-5Sil MS	BPX5	SLB-5ms
OPTIMA 5, OPTIMA 5 MS		ZB-5, ZB-5ms		Rxi-5ms	BP5ms	
	OV-17		007-17	Rtx-50		SPB-50
OPTIMA 17		ZB-50		Rxi-17		SPB-17
OPTIMA 17 MS		ZB-50		Rxi-17Sil MS	BPX50	
	OV-35	ZB-35	007-35	Rtx-35	BPX35, BPX608	SPB-35, SPB-608
OPTIMA 35 MS		MR2		Rxi-35Sil MS	BPX35	
OPTIMA 210				Rtx-200		
OPTIMA 225	OV-225		007-225	Rtx-225	BP225	SPB-225
OPTIMA 1301, OPTIMA 624	OV-624	ZB-624	007-1301, 007-624	Rtx-624	BP624	SPB-624
OPTIMA 624 LB		ZB-624		Rxi-624Sil MS	BP624	
OPTIMA 1301, OPTIMA 624	OV-1301	ZB-624	007-1301, 007-624	Rtx-624	BP624	SPB-624
OPTIMA 1701	OV-1701	ZB-1701, ZB-1701P	007-1701	Rtx-1701	BP10	Equity-1701
OPTIMA WAX	Carbowax 20M	ZB-Wax	007-CW	Rtx-Wax	BP20	
OPTIMA WAX plus		ZB-WaxPLUS		Stabilwax		Supelcowax-10

Ohio Valley®	Phenomenex®	Quadrex®	Restek®	SGE®	Supelco®
			Rtx-502.2		VOCOL
		007-608			SPB-608
			Rtx-DHA	BP1PONA	Petrocol DH
			Rtx-2887		Petrocol 2887, Petrocol EX2887
OV-351	ZB-FFAP		Stabilwax-DA	BP-21	Nukol
			Rt-2560		SPB-2560
		007-23		BPX70	SP-2330, SP-2331, SP-2380
	MR1, ZB-XLB		Rxi-XLB		
	ZB-BAC1		Rtx-BAC Plus 1		
	ZB-BAC2		Rtx-BAC Plus 2		
			Rtx-CLPesticides		
			Rtx-CLPesticides 2	Rtx-200	

Elite-1, Elite-1ms, Elite-1ht: 100% Dimethyl Polysiloxane

The Elite-1 100% dimethyl polysiloxane columns is a highly versatile, non-polar, crosslinked general purpose phase that is rugged, exhibiting long column lifetime, low bleed, and high maximum operating temperatures. The Elite-1ms is engineered for extremely low bleed for MS detectors. The Elite-1ht (High-Temp) is designed for reduced bleed when operating at higher temperature (up to 380 °C).

Primary Applications: Elite-1 columns are ideal for the analysis of non-polar petrochemical samples, such as detailed hydrocarbon analysis, hydrocarbon gases, petroleum oxygenates, petroleum aromatics, fuels, waxes, oils, sulfur compounds, mercaptans, and carbon disulfide. It also is an excellent phase for solvents, chemicals, flavors, fragrances, essential oils, air toxins, chlorofluorocarbons, arson analysis, pesticides, hydrocarbons and high-temperature applications.

Features and Benefits

- Temperature Range: -60 °C to 350 °C/400 °C
- Equivalent to USP G1, G2, and G38 phases

Elite-1 Structure

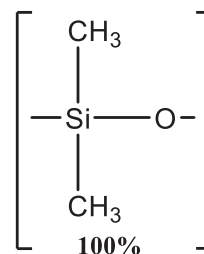

Elite-1

ID	df (mm)	Temp Limits (°C)	5 m Part No.	15 m Part No.	30 m Part No.	60 m Part No.	105 m Part No.
0.25 mm	0.10	-60 to 330/350		N9316006	N9316009	N9316012	
	0.25	-60 to 330/350		N9316007	N9316010	N9316013	
	0.50	-60 to 330/350		N9316686	N9316685		
	1.00	-60 to 320/340		N9316008	N9316011	N9316014	
0.32 mm	0.10	-60 to 330/350		N9316016	N9316022	N9316027	
	0.25	-60 to 330/350	N9316596	N9316017	N9316023	N9316028	
	0.50	-60 to 330/350			N9316021¹	N9316691	
	1.00	-60 to 320/340		N9316018	N9316024	N9316029	
	1.50	-60 to 310/330			N9316050	N9316580	
	3.00	-60 to 280/300		N9316019	N9316025	N9316030	
	5.00	-60 to 260/280		N9316020	N9316026	N9316031	
0.45 mm	0.13	-60 to 340/360		N9316032			
	0.42	-60 to 310/330		N9316037	N9316041		
	1.27	-60 to 310/330		N9316034	N9316038	N9316042	
	2.55	-60 to 270/290		N9316035	N9316039		N9316043
	4.25	-60 to 260/280	N9316032	N9316036	N9316040		
0.53 mm	0.15	-60 to 320/340		N9316045			
	0.50	-60 to 310/330		N9316049	N9316053		
	1.50	-60 to 310/330		N9316046	N9316050	N9316054	
	3.00	-60 to 270/290		N9316047	N9316051	N9315499	N9316692
	5.00	-60 to 270/290	N9316044	N9316048	N9316052		

ID	df (mm)	Temp Limits (°C)	10 m Part No.	12 m Part No.	20 m Part No.	25 m Part No.	50 m Part No.
0.05 mm	0.05	-60 to 330/350	N9316056				
	0.20	-60 to 330/350	N9316057				
0.10 mm	0.10	-60 to 330/350	N9316058				
	0.40	-60 to 320/340			N9316061		
0.18 mm	0.18	-60 to 330/350	N9316001		N9316003		
	0.40	-60 to 320/340	N9316002		N9316004		N9316005²
0.20 mm	0.33	-60 to 330/350		N9316062		N9316063	N9316064

¹ N9316021: Elite-1, 25M x 0.32mm x 0.52µm ² the length of N9316005 is 40m

NEW

Elite-1ms (Mass Spectrometry)

ID	df (mm)	Temp Limits (°C)	15 m	20 m	30 m	60 m
			Part No.	Part No.	Part No.	Part No.
0.18 mm	0.18	-60 to 330/350		N9305635		
	2.00	-60 to 330/350		N9305636		
0.25 mm	0.25	-60 to 330/350	N9305637		N9305638	N9305639
	0.50	-60 to 330/350	N9305640		N9305641	N9305642
	1.00	-60 to 330/350	N9305643		N9305644	N9305645
0.32 mm	0.25	-60 to 330/350	N9305646		N9305647	N9305648
	0.50	-60 to 330/350	N9305649		N9305650	N9305651
	1.00	-60 to 330/350			N9305652	N9305653
	4.00	-60 to 330/350			N9305654	

Elite-1ht (High Temperature)

ID	df (mm)	Temp Limits (°C)	15 m	30 m
			Part No.	Part No.
0.25 mm	0.10	-60 to 400	N9316268	N9316269
0.32 mm	0.10	-60 to 400	N9316270	N9316271



Elite-5, Elite-5 Amine & Elite-5ht: 5% Diphenyl / 95% Dimethyl Polysiloxane

5% diphenyl/95% dimethyl polysiloxane stationary phase is a general purpose, low polarity phase that is the most popular GC stationary phase used for a wide variety of applications. These columns are commonly used for analysis of drugs, pesticides, hydrocarbons, PCBs, essential oils, semivolatiles and solvent impurities. The Elite-5 is a crosslinked phase in which all residual catalysts and low molecular weight fragments have been removed providing a tight mono-modal distribution and extremely low bleed. The Elite-5 is available in a standard version stable up to 350 °C, a high temperature version stable up to 400 °C and an Amine version engineered for analysis of amines and other basic compounds.

Features and Benefits

- Temperature Range: -60 °C to 350 °C
- Equivalent to USP G27 & G36 phases

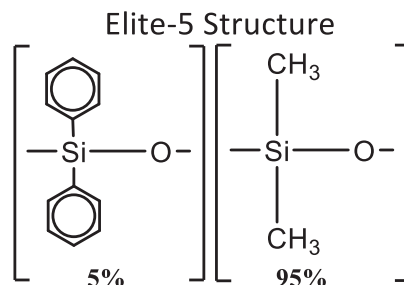

Elite-5

			5 m	15 m	30 m
ID	df (mm)	Temp Limits (°C)	Part No.	Part No.	Part No.
0.25 mm	0.10	-60 to 330/350	N9316072	N9316075	N9316078
	0.25	-60 to 330/350	N9316073	N9316076	N9316079
	1.00	-60 to 320/340	N9316074	N9316077	N9316080
0.32 mm	0.10	-60 to 330/350	N9316081	N9316085	N9316089
	0.25	-60 to 330/350	N9316082	N9316086	N9316090
	1.00	-60 to 320/340	N9316083	N9316087	N9316091
0.45 mm	0.13	-60 to 340/360			N9316097
	0.42	-60 to 310/330	N9316093	N9316096	
	1.27	-60 to 310/330	N9316092	N9316094	
	4.25	-60 to 260/280		N9316095	
0.53 mm	0.50	-60 to 310/330	N9316099	N9316102	
	1.50	-60 to 310/330	N9316098	N9316100	N9316103
	5.00	-60 to 270/290		N9316101	

			10 m	20 m	40 m
ID	df (mm)	Temp Limits (°C)	Part No.	Part No.	Part No.
0.05 mm	0.05	-60 to 325/350	N9316104		
	0.20	-60 to 325/350	N9316105		
0.10 mm	0.10	-60 to 330/350		N9316108	
	0.40	-60 to 320/340		N9316109	
0.18 mm	0.18	-60 to 330/350	N9316066	N9316068	
	0.4	-60 to 320/340	N9316067	N9316069	N9316071
0.20 mm	0.33	-60 to 330/350	N9316110 ¹	N9316111 ¹	N9316112 ¹

¹ The lengths of N9316110, N9316111 and N9316112 are 12 m, 25 m and 50 m, respectively

Elite-5 Amine

			15 m	30 m
ID	df (mm)	Temp Limits (°C)	Part No.	Part No.
0.25 mm	0.50	-60 to 300/315	N9316684	N9316673
	1.00	-60 to 300/315	N9316674	N9316675
0.32 mm	1.00	-60 to 300/315	N9316676	N9316677
	1.50	-60 to 290/305	N9316678	N9316679
0.53 mm	1.00	-60 to 290/305		N9316680
	3.00	-60 to 280/295	N9316681	N9316682

Elite-5ht (High Temperature)

			15 m	30 m
ID	df (mm)	Temp Limits (°C)	Part No.	Part No.
0.25 mm	0.10	-60 to 400	N9316272	N9316273
0.32 mm	0.10	-60 to 400	N9316374	N9316275

Elite-5ms: Extremely Low Bleed and Inertness

The Elite-5ms phase incorporates a phenyl group in the polymer backbone to improve thermal stability, reduce bleed and make the phase less prone to oxidation. This results in a phase that is inert to active compounds with extremely low bleed to meet the requirements of sensitive MS detectors. It is a general purpose column ideal for GC/MS analysis of semivolatiles, PAHs, chlorinated hydrocarbons, phthalates, phenols, amines, organochlorine & organophosphorus pesticides, drugs and solvent impurities.

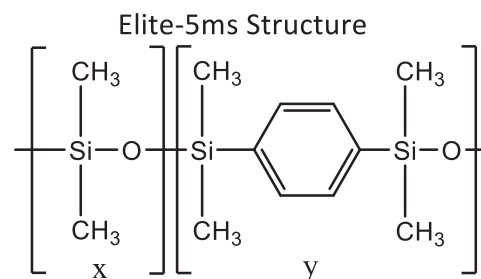

Features and Benefits

- Temperature Range: -60 °C to 350 °C
- Similar to USP G27 & G36 phases

Elite-5ms

ID	df (mm)	Temp Limits (°C)	15 m	30 m	60 m
			Part No.	Part No.	Part No.
0.18 mm	0.18	-60 to 325/340		N9316276 ¹	N9316277 ¹
0.20 mm	0.33	-60 to 330/350	N9316301 ²	N9316302 ²	N9316303 ²
0.25 mm	0.25	-60 to 330/350	N9316279	N9316282	N9316286
	0.50	-60 to 330/350		N9316284	
	1.00	-60 to 325/350	N9316280	N9316283	N9316287
0.32 mm	0.25	-60 to 330/350	N9316289	N9316293	N9316297
	0.50	-60 to 330/350		N9316295	
	0.52	-60 to 330/350		N9316291 ³	
	1.00	-60 to 325/350	N9316290	N9316294	N9316298
0.53 mm	1.50	-60 to 310/330	N9316299	N9316300	

¹ The lengths of N9316276 and N9316277 are 20 m and 40 m, respectively

² The lengths of N9316301, N9316302 and N9316303 are 12 m, 25 m and 50 m, respectively

³ The length of N9316291 is 25 m.

Elite-5ms II: Tested for Low Bleed Performance

The Elite-5ms II columns incorporate the same phase as the Elite-5 columns but are specifically tested for low bleed performance.

Features and Benefits

- Temperature Range: -60 °C to 350 °C
- Equivalent to USP G27 & G36 phases

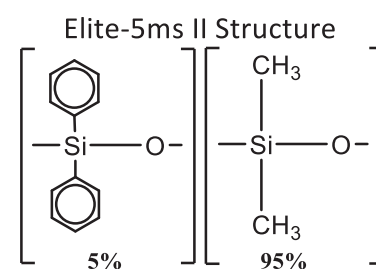

NEW

Elite-5ms II

ID	df (mm)	Temp Limits (°C)	15 m	30 m	60 m
			Part No.	Part No.	Part No.
0.25 mm	0.10	-60 to 330/350	N9305655	N9305656	N9305657
	0.25	-60 to 330/350	N9305658	N9305659	N9305660
	0.50	-60 to 330/350	N9305661	N9305662	N9305663
	1.00	-60 to 325/350	N9305664	N9305665	
0.32 mm	0.10	-60 to 330/350	N9305666	N9305667	N9305668
	0.25	-60 to 330/351	N9305669	N9305670	N9305671
	0.50	-60 to 330/350		N9305672	N9305673
	1.00	-60 to 325/350	N9305674	N9305675	N9305698

Elite-17: (50%-phenyl)-methylpolysiloxane

The Elite-17 columns are general purpose, mid-polarity, (50%-phenyl)-methylpolysiloxane phases for the analysis of pesticides, herbicides, phthalate esters, sterols, and rosin acids. All Elite 17 phases incorporate a crosslinking technology for very low bleed and long column lifetimes.

Features and Benefits

- Temperature Range: 40 °C to 320 °C
- Equivalent to USP G3 phase

Elite-17 Structure

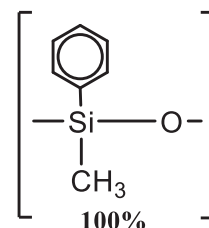

Elite-17

ID	df (mm)	Temp Limits (°C)	5 m	15 m	30 m	60 m
			Part No.	Part No.	Part No.	Part No.
0.25 mm	0.15	40 to 300/320		N9316117	N9316120	
	0.25	40 to 300/320		N9316118	N9316121	N9316123
	0.50	40 to 290/310		N9316119	N9316122	
0.32 mm	0.15	40 to 300/320		N9316124	N9316127	
	0.25	40 to 300/320		N9316125	N9316128	
	0.50	40 to 290/310		N9316126	N9316129	
0.45 mm	0.85	40 to 270/290		N9316131	N9316132	N9316133
	1.70	40 to 260/280	N9316130			
0.53 mm	1.00	40 to 260/280		N9316135	N9316136	N9316137
	2.00	40 to 250/270	N9316134			

ID	df (mm)	Temp Limits (°C)	10 m	20 m
			Part No.	Part No.
0.05 mm	0.05	40 to 280/300	N9316138	
	0.10	40 to 280/300	N9316139	
0.10 mm	0.02	40 to 280/300	N9316141	
	0.10	40 to 280/300	N9316140	N9316142
	0.20	40 to 280/300		N9316143
0.18 mm	0.18	40 to 310/330	N9316113	N9316115
	0.3	40 to 300/320	N9316114	N9316116

Elite-17ht (High Temperature)

ID	df (mm)	Temp Limits (°C)	15 m	30 m	60 m
			Part No.	Part No.	Part No.
0.25 mm	0.15	40 to 300/320	N9316263	N9316264	
0.32 mm	0.15	40 to 300/320	N9316265	N9316266	N9316267

Elite-17ms: Mid-polarity, Very Low Bleed

The Elite-17ms columns are general purpose, mid-polarity columns that are coated with a crosslinked, (50%-diphenyl)-dimethylpolysiloxane engineered for very low bleed to meet the requirements of sensitive MS detectors.

Features and Benefits

- Temperature Range: 40 °C to 320 °C
- Equivalent to USP G3 phase

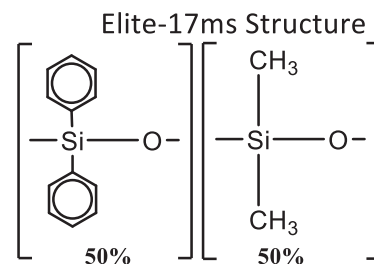

Elite-17ms

ID	df (mm)	Temp Limits (°C)	15 m Part No.	30 m Part No.	60 m Part No.
0.18 mm	0.18	40 to 320/340	N9316534		
0.25 mm	0.15	40 to 300/320	N9316535	N9316537	
	0.25	40 to 300/320	N9316536	N9316538	N9316539
0.32 mm	0.15	40 to 300/320	N9316540	N9316542	
	0.25	40 to 300/320	N9316541		

Elite-17ms+: High Temperature, Extremely Low Bleed

The new Elite-17ms+ columns are general purpose, mid-polarity columns that are coated with a unique blend of linked dimethyl polysiloxanes and diphenyl polysiloxanes that is inert and selective for active environmental compounds, such as PAHs, while maintaining a similar selectivity and polarity as traditional Elite-17 phases. This phase has been engineered for extremely low bleed as required by MS detectors at higher temperature (up to 360 °C) as required for sensitive MS detectors.

Features and Benefits

- Temperature Range: 40 °C to 360 °C
- Equivalent to USP G3 phase

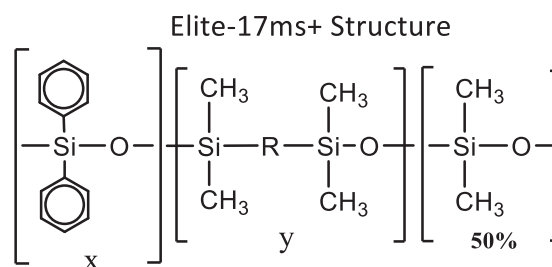

NEW

Elite-17ms+

ID	df (mm)	Temp Limits (°C)	10 m Part No.	15 m Part No.	20 m Part No.	30 m Part No.	60 m Part No.
0.15 mm	0.15 mm	40 to 340/360	N9305677		N9305678		
0.18 mm	0.18 mm	40 to 340/360			N9305679		
	0.36 mm	40 to 340/360			N9305680		
0.25 mm	0.25 mm	40 to 340/360		N9305681		N9305682	N9305685
0.32 mm	0.25 mm	40 to 340/360		N9305683		N9305684	

Elite-35: (35%-diphenyl)-dimethylpolysiloxane

The Elite-35 columns are general purpose, mid-polarity columns that are coated with a crosslinked, (35%-diphenyl)-dimethylpolysiloxane commonly used for organochlorine pesticides, PDB congeners (e.g. Alaclor mixes), herbicides, pharmaceuticals, sterols, phthalate esters and rosin acids. The Elite-35 column is a popular confirmation column for pesticides and herbicides, in conjunction with an Elite-5 or Elite-1701. The higher phenyl content results in useful elution order and retention time changes.

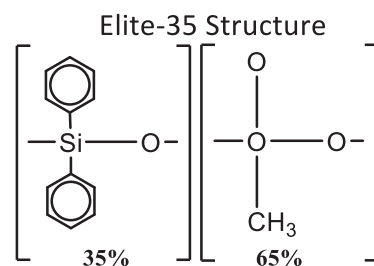

Features and Benefits

- Temperature Range: 40 °C to 320 °C
- Equivalent to USP G42 phase

Elite-35

ID	df (mm)	Temp Limits (°C)	15 m	30 m
			Part No.	Part No.
0.25 mm	0.15	40 to 300/320		N9316144
	0.25	40 to 300/320		N9316145
0.32 mm	0.25	40 to 300/320		N9316146
	0.50	40 to 290/310		N9316147
0.45 mm	0.42	40 to 290/310		N9316150
	0.85	40 to 280/300	N9316148	N9316149
0.53 mm	0.50	40 to 260/280		N9316153
	1.00	40 to 260/280	N9316151	N9316152

Elite-35ms: High Temperature, Extremely Low Bleed

The Elite-35ms columns are general purpose, mid-polarity columns that are coated with a unique blend of linked dimethyl polysiloxanes and diphenyl polysiloxanes that are inert and selective for substituted polar compounds, such as drugs, pesticides, herbicides, PCBs and phenyls, while maintaining a similar selectivity and polarity as traditional Elite-35 phases. This phase has been engineered for extremely low bleed as required by MS detectors at higher temperature (up to 360 °C) as required for sensitive MS detectors.

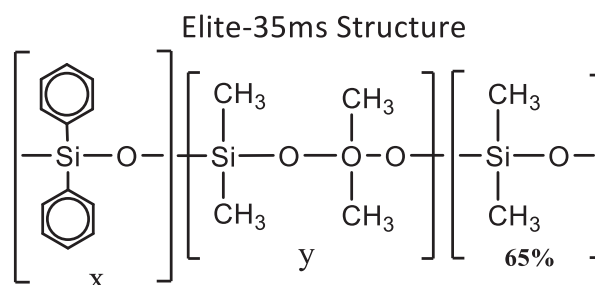

Features and Benefits

- Temperature Range: 50 °C to 340 °C/360 °C
- Equivalent to USP G42 phase

Elite-35ms

NEW

ID	df (mm)	Temp Limits (°C)	15 m	30 m
			Part No.	Part No.
0.25 mm	0.25 mm	50 to 340/360	N9305686	N9305687
	0.50 mm	50 to 340/360	N9305688	N9305689
	1.00 mm	50 to 320/340	N9305690	N9305691
0.32 mm	0.25 mm	40 to 340/360	N9305692	N9305693
	0.50 mm	40 to 340/360	N9305694	N9305695
	1.00 mm	40 to 320/340	N9305696	N9305697

Elite-200: (Trifluoropropyl)-methylpolysiloxane

Elite-200 columns contain a (trifluoropropyl)-methylpolysiloxane stationary phase that has a unique selectivity which changes elution orders and resolves compounds that phenyl, cyano, or Carbowax® phases cannot. These columns have accomplished many difficult separations not possible on any other bonded stationary phase. Many analysts consider these the best, most inert mid-polarity columns available. The Elite-200 column offers exceptional thermal stability, low bleed, and superior inertness—even for active compounds such as phenols, and with sensitive detectors such as ECDs, NPDs, and MSDs. It is a good general purpose column for solvents, Freon® fluorocarbons, alcohols, ketones, silanes, glycols, and drugs of abuse. An excellent column for confirmation of phenols, nitrosamines, organochlorine pesticides, chlorinated hydrocarbons, and chlorophenoxy herbicides when paired with an Elite-5 column.

Elite-200 Structure

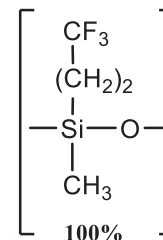

Features and Benefits

- Temperature Range: 40 °C to 320 °C
- Equivalent to USP G6 phase

Elite-200

ID	df (mm)	Temp Limits (°C)	15 m	30 m	60 m
			Part No.	Part No.	Part No.
0.25 mm	0.10	-20 to 320/340	N9316616	N9316617	
	0.25	-20 to 320/340	N9316618	N9316619	
	0.50	-20 to 310/330	N9316620	N9316621	
	1.00	-20 to 290/310	N9316622	N9316623	N9316624
0.32 mm	0.25	-20 to 320/340	N9316625	N9316626	
	0.50	-20 to 310/330	N9316627	N9316628	
	1.00	-20 to 290/310	N9316629	N9316630	N9316631
	1.50	-20 to 280/300	N9316632	N9316633	N9316634
0.53 mm	0.25	-20 to 310/330	N9316635	N9316636	N9316637
	0.50	-20 to 300/320	N9316638	N9316639	N9316640
	1.00	-20 to 290/310	N9316641	N9316642	N9316643
	1.50	-20 to 280/300	N9316644	N9316645	N9316646
	3.00	-20 to 260/280	N9316647	N9316648	N9316649

Elite-225: (50%-cyanopropylmethyl)-phenylmethylpolysiloxane

The Elite-225 is a general purpose column for the analysis of FAMES, carbohydrates, sterols and flavor compounds. The cyanopropyl-containing Elite-225 phase is slightly less polar than bonded polyethylene glycol (PEG) phases, but it can be used for many of the same applications. Improvements to the Elite-225 polymer have increased thermal stability, reduced bleed, and improved inertness. The Elite-225 column provides a 20 °C thermal stability advantage over other "225" columns because of our unique polymer synthesis technology and proprietary siloxane deactivation. In most similar columns, the Carbowax® deactivation layer is not fully compatible with the cyanopropyl siloxane polymer, which can cause adsorption, tailing of active compounds, and lower efficiency.

Features and Benefits

- Temperature Range: 40 °C to 240 °C
- Equivalent to USP G7, G19 phases

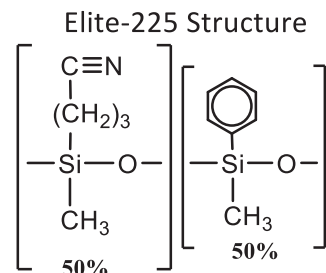

Elite-225

ID	df (mm)	Temp Limits (°C)	10 m Part No.	15 m Part No.	20 m Part No.	30 m Part No.	60 m Part No.
0.05 mm	0.05	45 to 220/240	N9316186				
0.10 mm	0.10	45 to 220/240			N9316187		
0.18 mm	0.2	45 to 220/240	N9316172		N9316173		
0.25 mm	0.15	45 to 220/240		N9316174		N9316176	N9305631
	0.25	45 to 220/240		N9316175		N9316177	
0.32 mm	0.15	45 to 220/240		N9316178		N9316180	
	0.25	45 to 220/240		N9316179		N936181	
0.45 mm	0.85	40 to 200/220		N9316182		N9316183	
0.53 mm	1.00	40 to 200/220		N9316184		N9316185	

Elite-1301: (6%-cyanopropylphenyl)-methylpolysiloxane

The Elite-1301 column is a general purpose low to mid-polarity phase commonly used for the analysis of residual solvents, alcohols, oxygenates and volatile organic compounds. Many analysts feel the Elite-1301 column is the best cyanosiloxane bonded stationary phase available, with no other column supplier providing lower bleed, longer lifetime, or better inertness. Our polymer is fully characterized to ensure long-term reproducibility, column-to-column consistency, and low bleed—even with sensitive detectors such as ECD and MS.

Features and Benefits

- Temperature range: -20 °C to 280 °C
- Equivalent to USP G43 phase

Elite-1301

ID	df (mm)	Temp Limits (°C)	15 m Part No.	30 m Part No.	60 m Part No.
0.18 mm	0.40	-20 to 280	N9316211		
0.25 mm	0.25	-20 to 280	N9316212	N9316214	N9316216
	1.00	-20 to 260/280	N9316213	N9316215	N9316217
0.32 mm	0.25	-20 to 280	N9316218	N9316220	N9316222
	1.00	-20 to 260/280	N9316219	N9316221	N9316223
0.45 mm	0.85	-20 to 260/280	N9316224	N9316225	
0.53 mm	1.00	-20 to 260/280	N9316226	N9316227	

Elite-1301 Structure

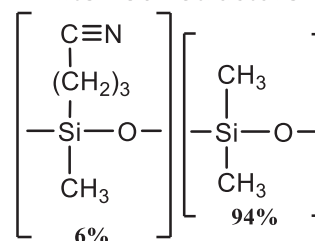

Elite-1701: (14%-cyanopropylphenyl)-methylpolysiloxane

The Elite-1701 is a good mid-polarity general purpose column for the analysis of alcohols, oxygenates, PCB congeners (e.g. Aroclor mixes), and pesticides. It is one of the more popular stationary phases used in capillary GC. The mix of cyano and phenyl functional groups increases the polarity and offers a different elution order relative to less polar Elite-1 or Elite-5 columns. An Elite-1701 column is ideal for confirmation analysis in combination with an Elite-35 or Elite-5 column. The polymer is fully characterized to ensure long-term reproducibility, column-to-column consistency, and low bleed – even with sensitive detectors such as ECD and MS.

Features and Benefits

- Temperature Range: -20 °C to 280 °C
- Equivalent to USP G46 phase

Elite-1701 Structure

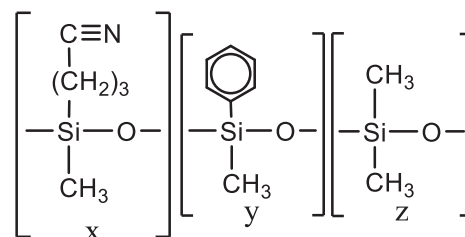

Elite-1701

ID	df (mm)	Temp Limits (°C)	15 m		30m	50 m	60 m
			Part No.	Part No.	Part No.	Part No.	
0.25 mm	0.15	-20 to 280	N9316230				N9316236
	0.25	-20 to 280	N9316231	N9316234			N9316237
	1.00	-20 to 260/280	N9316232	N9316235			N9316238
0.32 mm	0.15	-20 to 280	N9316239	N9316242			N9316246
	0.25	-20 to 280	N9316240	N9316243			N9316247
	1.00	-20 to 260/280	N9326141	N9316244	N9316245		N9316248
0.45 mm	0.42	-20 to 260/270	N9316250	N9316252			
	0.85	-20 to 250/270	N9316249	N9316251			
0.53 mm	0.50	-20 to 260/270	N9316254	N9316256			
	1.00	-20 to 250/270	N9316253	N9316255			

ID	df (mm)	Temp Limits (°C)	10 m	20 m
			Part No.	Part No.
0.05 mm	0.05	-20 to 280	N9316257	
	0.20	-20 to 280	N9316258	
0.10 mm	0.10	-20 to 280		N9316259
	0.40	-20 to 270/280		N9316250
0.18 mm	0.4	-20 to 270/280	N9316228	N9316229

Elite-WAX: Polar Polyethylene glycol (PEG)

The Elite-WAX column is a general purpose polar PEG phase commonly used for the analysis of polar compounds like alkenols, glycols and aldehydes. The extended operating temperature range up to 250 °C allowing analysis of compounds that have a wide volatility range. Selectivity of the Elite-WAX is comparable to other Carbowax® columns for compounds of intermediate to high polarity.

Features and Benefits

- Temperature range: 20 °C to 250 °C
- Equivalent to USP G14, G15, G16, G20 and G39 phases

Elite-WAX Structure

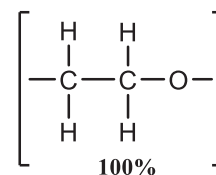

Elite-WAX

ID	df (mm)	Temp Limits (°C)	15 m	30m	60 m
			Part No.	Part No.	Part No.
0.25 mm	0.15	20 to 250	N9316399	N9316402	N9316405
	0.25	20 to 250	N9316400	N9316403	N9316406
	0.50	20 to 250	N9316401	N9316404	N9316407
0.32 mm	0.15	20 to 250	N9316408	N9316411	
	0.25	20 to 250	N9316409	N9316412	N9316416
	0.50	20 to 250	N9316410	N9316413	N9316417
0.45 mm	0.42	20 to 250	N9316420	N9316422	
	0.85	20 to 240/250	N9316419	N9316421	N9316423
	1.70	50 to 230	N9316418		
0.53 mm	0.50	20 to 250	N9316426	N9316428	
	1.00	20 to 240/250	N9316425	N9316427	N9316429

Elite-MWAX: Metal Column

ID	df (mm)	Temp Limits (°C)	30 m
			Part No.
0.53 mm	1.00	20 to 240/250	N9316478

Elite-WAX ETR: Extended Temperature Range WAX

The Elite-WAX ETR columns are manufactured with a special bonding process that binds the Carbowax® polymer to the polar deactivated silica. This results in a low bleed WAX column that exhibits extended lifetimes even when repeatedly heated to 260 °C. The bonding mechanism of this column produces very stable polar retention that does not shift as often as observed with other WAX-type columns. Additionally, the bonding mechanism makes this column rugged enough to stand up to repeated water injections and allows solvent washing to rejuvenate the column. The Elite-WAX ETR can be used for a wide range of compounds and matrices such as: FAMES, flavor compounds, essential oils, solvents, aromatics, acrolein/acrylonitrile (EPA 603), oxygenated compounds, impurities in water matrices and alcoholic beverages.

Features and Benefits

- Temperature Range: 40 °C to 260 °C
- Equivalent to to USP G14, G15, G16, G20 and G39 phases

Elite-WAX ETR

ID	df (mm)	Temp Limits (°C)	5 m	15 m	30m	50 m	60 m
			Part No.	Part No.	Part No.	Part No.	Part No.
0.25 mm	0.25	40 to 250		N9316547	N9316549		N9316551
	0.50	40 to 250		N9316548	N9316550		
0.32 mm	0.25	40 to 250		N9316552	N9316555		N9316559
	0.50	40 to 250		N9316553	N9316556		N9316560
	1.00	40 to 240/250		N9316554	N9316557	N9316558	N9316561
0.45 mm	0.85	40 to 240		N9316563	N9316564		N9316565
	1.70	40 to 230/250	N931656				
0.53 mm	1.00	40 to 240/250		N9316567	N9316569		N9316571
	2.00	40 to 220/230	N9316566	N9316568	N9316570		

Elite-624: EPA Volatile Organic Pollutants

The Elite-624 column is a specially engineered, low to mid-polarity (6%-cyanopropylphenyl)-dimethylpolysiloxane phase. The unique polarity of the Elite-624 column makes it ideal for analyzing volatile organic pollutants and it is recommended in U.S. EPA methods. Although the Elite-502.2 column is recommended in many methods, the Elite-624 column offers better resolution of early eluting compounds. The Elite-624 phase produces greater than 90% resolution of the first six gases in EPA Methods 8260 and 524.2. This stationary phase is especially well-suited for EPA Method 524.2 since it resolves 2-nitropropane from 1,1-dichloropropanone, which share quantification ion m/z 43 and must be separated chromatographically.

Features and Benefits

- Temperature range: -20 °C to 240 °C
- Equivalent to USP G43 phase

Elite-624 Structure

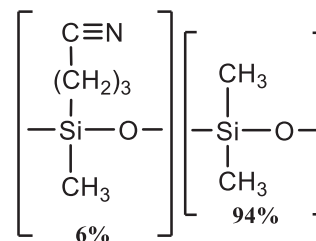

Elite-624

ID	df (mm)	Temp Limits (°C)	20 m Part No.	25 m Part No.	30 m Part No.	60 m Part No.	75 m Part No.
0.18 mm	1.00	-20 to 240	N9316200				
0.20 mm	1.12	-20 to 240		N9316209			
0.25 mm	1.40	-20 to 240			N9316201	N9316202	
0.32 mm	1.80	-20 to 240			N9316203	N9316204	
0.45 mm	2.55	-20 to 240			N9316205		N9316206
0.53 mm	3.00	-20 to 240			N9316207		N9316208

Elite-624ms: Low Bleed, High Thermal Stability

The Elite-624ms incorporates a unique proprietary blend of cyanopropyl and methyl siloxanes that results in a very inert, extremely low bleed and high thermal stability column. This column provides excellent peak shape for a wide range of compounds and is highly selective for residual solvents making it a great choice for USP<467>. These columns are manufactured for column-to-column reproducibility, so they are well suited for validated methods.

Features and Benefits

- Temperature Range: -20 °C to 320 °C
- Similar to USP 43 phase

Elite-624ms Structure

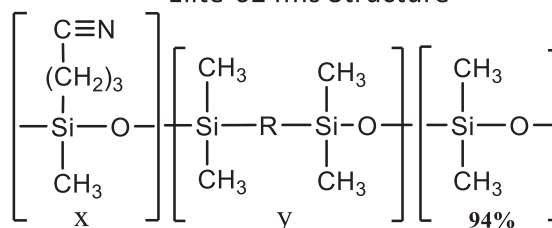

Elite-624ms

NEW

ID	df (mm)	Temp Limits (°C)	20 m Part No.	30 m Part No.	60 m Part No.
0.18 mm	1.00	-20 to 240	N9315067		
0.25 mm	1.40	-20 to 240		N9315068	
0.32 mm	1.80	-20 to 240		N9315069	N9315070

Elite-BAC Advantage: Blood Alcohol Content

The Elite-BAC Advantage columns are optimized for selectivities guaranteed to resolve ethanol, internal standards, and frequently encountered interferences. These application-specific columns for blood alcohol analysis baseline separate all critical compounds, including ethanol, methanol, acetone, tert-butanol, acetaldehyde, isopropanol, and n-propanol, in less than 2 minutes. Every Elite-BAC 1 Advantage and Elite-BAC 2 Advantage column is qualified with a test mix containing these important BAC target compounds to ensure reproducibility. These columns, baseline separate all blood alcohol compounds in blood, breath, or urine, in less than 2 minutes, under isothermal conditions. Isothermal analysis increases productivity by eliminating the need for oven cycling. Confirmation is easily achieved with this tandem set because there are two elution order changes between the columns.

Features and Benefits

- Robust and reproducible column chemistry ensures longer column lifetime and consistent results
- Stable to 260 °C

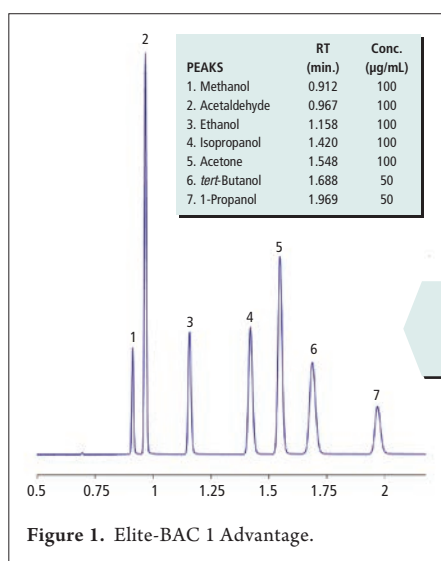

- Clear baseline resolution
- Symmetrical peaks
- Run time under 2 min

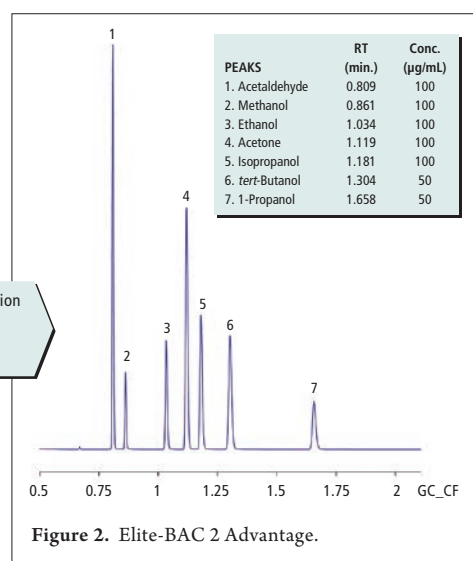

Elite-BAC Advantage

NEW

Column Type	ID	df (mm)	Temp Limits (°C)	10 m	30 m
				Part No.	Part No.
Elite-BAC 1 Advantage	0.18 mm	1.00	-20 to 240/260	N9315075	
	0.32 mm	1.80	-20 to 240/260		N9315071
	0.53 mm	3.00	-20 to 240/260		N9315072
Elite-BAC 2 Advantage	0.18 mm	0.34	-20 to 240/260	N9315076	
	0.32 mm	0.60	-20 to 240/260		N9315073
	0.53 mm	1.00	-20 to 240/260		N9315074
Elite-BAC 3 Advantage	0.18 mm	0.30	20 to 250	N9316575	

Elite-VMS: Volatile Organic Pollutants by GC/MS

Elite-VMS columns offer lower bleed, better selectivity, and overall faster analysis for separating volatile organic compounds. These columns are capable of separating the compounds listed in U.S. EPA Method 8260B in under 10 minutes. The Elite-VMS stationary phase is a highly stable polymer that provides outstanding analysis of volatile compounds on MS detectors. The 0.18 and 0.25 mm ID columns allow sample splitting at the injection port, eliminating the added expense and maintenance of a jet separator. A 0.45 mm or 0.53 mm ID column can be directly connected to the purge-and-trap transfer line in a system equipped with a jet separator.

Features and Benefits

- Temperature Range: -40 °C to 240/260 °C
- No known equivalent phases

Elite-VMS

ID	df (mm)	Temp Limits (°C)	30 m	60 m	75 m
			Part No.	Part No.	Part No.
0.18 mm	1.00	-40 to 240/260	N9316650¹	N9316651¹	
0.25 mm	1.40	-40 to 240/260	N9316652	N9316653	
0.32 mm	1.80	-40 to 240/260	N9316654	N9316655	
0.45 mm	2.55	-40 to 240/260	N9316656	N9316657	
0.53 mm	3.00	-40 to 240/260	N9316658	N9316659	N9316660

¹ The lengths of N9316650 and N9316651 are 20 m and 40 m, respectively.

Elite-XLB: Exceptionally Low Bleed for GC/MS

The Elite-XLB phase is a proprietary low-polarity, very inert and exceptionally low bleed column for GC/MS analysis of pesticides, PCB congeners (e.g., Aroclor mixes) and PAHs. Improvements in polymer synthesis and tubing deactivation enable us to make inert, stable Elite-XLB columns especially well-suited for analyzing active, high molecular weight compounds with sensitive GC-MS systems, including ion trap detectors. Excellent efficiency, coupled with inertness, low bleed, and high thermal stability, make Elite-XLB columns ideal for analyzing semivolatile compounds in drinking water (e.g., US EPA Method 525).

Features and Benefits

- Temperature Range: 30 °C to 340/360 °C
- No known equivalent phases

Elite-XLB

ID	df (mm)	Temp Limits (°C)	15 m	30 m	60 m
			Part No.	Part No.	Part No.
0.18 mm	0.18	40 to 340/360		N9316480¹	
0.20 mm	0.33	40 to 340/360	N9316496²	N9316497²	
0.25 mm	0.10	40 to 340/360		N9316483	
	0.25	40 to 340/360	N9316481	N9316484	N9316487
	1.00	40 to 340/360	N9318482	N9316485	
0.32 mm	0.10	40 to 340/360		N9316489	
	0.25	40 to 340/360	N9316488	N9316490	N9316493
	0.50	40 to 340/360		N9316492	
	1.00	40 to 340/360		N9316491	
0.53 mm	1.50	40 to 320/340	N9316494	N9316495	

¹ The length of N9316480 is 20 m.

² The lengths of N9316496 and N9316497 are 12 m and 25 m, respectively.

Elite-Volatiles: Volatile Organic Compounds

The Elite-Volatiles stationary phase and optimized column dimensions provide low bleed, excellent resolution, and fast analysis times for volatile organic pollutants. These columns are excellent for U.S. EPA method 8021 compounds.

Features and Benefits

- Temperature Range: -20 °C to 240 °C
- Proprietary phase

Elite-Volatiles

ID	df (mm)	Temp Limits (°C)	30 m	60 m	75 m
			Part No.	Part No.	Part No.
0.25 mm	1.40	-20 to 240	N9316388	N9316389	
0.32 mm	0.10	-20 to 240	N9316390	N9316391	
0.45 mm	2.55	-20 to 240	N9316392		N9316393

Elite-CLPesticides: Chlorinated Pesticides

Elite-CLPesticides is specially designed to overcome the coelutions and analyte breakdown typically encountered in chlorinated pesticide analyses for U.S. EPA methods 8081, 608, and CLP. Column bleed measured by ECD is extremely low at temperatures greater than 300 °C, which is critical for baking out the column to remove high-boiling compounds commonly found in pesticide/PCB extracts.

Primary Applications: Chlorinated Pesticides and Herbicides. U.S. EPA Methods 504, 608, 619, 8081, 8151, and CLP.

Features and Benefits

- Thermally stable to 340 °C
- Low column bleed – ideal for ECD or GC/MS analysis
- Exceeds performance criteria for U.S. EPA Methods 8081, 608 and CLP
- Baseline separation in less than 15 minutes

Elite-CLPesticides for Chlorinated Pesticides

Column Type	ID	df (mm)	Temp Limits (°C)	10 m	30 m
				Part No.	Part No.
Elite-CLPesticides	0.25 mm	0.25	-60 to 320/340	N9316661	N9316662
	0.32 mm	0.50	-60 to 320/340	N9316663	N9316664
	0.53 mm	0.50	-60 to 300/320	N9316665	N9316666
Elite-CLPesticides 2	0.25 mm	0.20	-20 to 240/260	N9316667	N9316668
	0.32 mm	0.25	-20 to 240/260	N9316669	N9316670
	0.53 mm	0.42	-20 to 240/260	N9316671	N9316672

Elite-502.2: U.S. EPA Method 502.2

Application: Analysis of volatiles by U.S. EPA method 502.2

Phase: Proprietary Dimethyl-diphenyl polysiloxane, low-polarity

ID	df (mm)	Temp Limits (°C)	60 m	75 m	105 m
			Part No.	Part No.	Part No.
0.25 mm	1.40	0 to 250/270	N9316498		
0.45 mm	2.55	0 to 250/270		N9316188	N9316189
0.53 mm	3.00	0 to 250/270			N9316190

Elite-RX: Drugs of Abuse

Application: Analysis of drugs of abuse

Phase	ID	df (mm)	Temp Limits (°C)	12 m	25 m
				Part No.	Part No.
Elite-1	0.20 mm	0.33	-60 to 330/350	N9316345	N9316346
Elite-5ms	0.20 mm	0.33	-60 to 330/350	N9316349	N9316350
Elite-17	0.20 mm	0.33	40 to 300/320	N9316347	N9316348

Elite-Betacylodextrin: Chiral Separations

Description: General-purpose chiral, Chiral compounds in essential oils

Column Type	ID	df (mm)	Temp Limits (°C)	30 m
				Part No.
Elite-Betacydex	0.25 mm	0.25	40 to 230	N9316319
Elite-Cyclosil B	0.25 mm	0.25	40 to 230	N9316545

Elite-608

Application: Analysis of semivolatile pesticides by U.S. EPA method 608

Phase: Phenyl methyl polysiloxane, mid-polarity

ID	df (mm)	Temp Limits (°C)	60 m	75 m	105 m
			Part No.	Part No.	Part No.
0.32 mm	0.50	40 to 290/310		N9316191	
0.45 mm	0.42	40 to 270/290	N9316194	N9316195	N9316189
	0.70	40 to 260/280	N9316192	N9316193	N9316190
0.53 mm	0.50	40 to 270/290	N9316198	N9316199	
	0.83	40 to 260/280	N9316196	N9316197	

Elite-SimDist

Application: Simulated distillation

Phase: Specially processed dimethylpolysiloxane, non-polar

ID	df (mm)	Temp Limits (°C)	10 m
			Part No.
0.45 mm	2.55	-60 to 360	N9316261
0.53 mm	3.00	-60 to 360	N9316262

CAPILLARY COLUMNS - SPECIALTY PHASES

Elite-SimDist HT (High Temp)

Application: High temperature simulated distillation

Phase: Metal Column, 100% dimethylpolysiloxane, non-polar

			6 m
ID	df (mm)	Temp Limits (°C)	Part No.
0.53mm	0.15	-60 to 400	N9316572

Elite-TPH

Application: Analysis of total petroleum hydrocarbons

Phase: (5%-diphenyl)-dimethylpolysiloxane, low polarity

			30 m
ID	df (mm)	Temp Limits (°C)	Part No.
0.32 mm	0.25	-10 to 320	N9316386
0.45 mm	1.00	-10 to 290	N9316387

Elite-PONA

Application: Detailed analysis of petroleum naphtha

Phase: Specially processed dimethylpolysiloxane, non-polar

		50 m		100 m
ID	df (mm)	Temp Limits (°C)	Part No.	Part No.
0.20 mm	0.50	-60 to 300/320	N9316065	
0.25 mm	0.50	-60 to 300/320		N9316015

Elite-FFAP

Application: Free fatty acids

Phase: Nitroterephthalic acid modified PEG (bonded), polar

			15 m	30 m
ID	df (mm)	Temp Limits (°C)	Part No.	Part No.
0.25 mm	0.25	40 to 250	N9316351	N9316352
0.32 mm	0.25	40 to 250	N9316353	N9316354
0.45 mm	0.85	40 to 240/250	N9316355	N9316356
0.53 mm	1.00	40 to 240/250	N9316357	N9316358

Elite-23

Application: Analysis of cis/trans isomers in FAMES and dioxins.

Equivalent to USP G8, G48.

Phase: (5%-cyanopropylphenyl)-biscyanopropylpolysiloxane

		50 m		100 m
ID	df (mm)	Temp Limits (°C)	Part No.	Part No.
0.25 mm	0.15			N9316507
	0.25		N9316506	N9316508

Elite-MTBE

Application: Analysis of methyl t-butylether and other oxgenates

Phase: Proprietary low polarity phase

			30 m
ID	df (mm)	Temp Limits (°C)	Part No.
0.45 mm	2.55	10 to 250	N9316520
0.53 mm	3.00	10 to 250	N9316521

Elite-2560

Application: Application-specific column for cis/trans FAMES

Phase: Biscyanopropylpolysiloxane, Highly Polar

			100 m
ID	df (mm)	Temp Limits (°C)	Part No.
0.25 mm	0.20		N9311570

Elite-Alumina/KCI* PLOT

Inner Diameter (mm i.d.)	Length (mm)	Film Thickness (µm)	Temperature Limits (°C)	Part No.
0.53	50		up to 200	N9316544

* Lower Polarity than Elite Alumina.

Elite-Alumina PLOT Phase for Analysis of Light Hydrocarbons

Inner Diameter (mm i.d.)	Length (mm)	Film Thickness (µm)	Temperature Limits (°C)	Part No.
0.53	30		-60 to 200	N9316304
0.53	50		-60 to 200	N9316305

Note: -60 °C is the lowest temperature used on this phase in our lab. Lower temperatures may be used depending on the sample.

Elite-Cyclosil B PLOT for Chiral Separations

Inner Diameter (mm i.d.)	Length (mm)	Film Thickness (µm)	Temperature Limits (°C)	Part No.
0.25	30	0.25	35 to 230	N9316545
0.32	30	0.25	35 to 230	N9316546

Elite-Molesieve PLOT Phase for Analysis of Permanent Gases

Inner Diameter (mm i.d.)	Length (mm)	Film Thickness (µm)	Temperature Limits (°C)	Part No.
0.53	30	N/A	-60 to 300	N9316361

Note: -60 °C is the lowest temperature used on this phase in our lab. Lower temperatures may be used depending on the sample.

Elite-Q PLOT Phase for Analysis of Light Gases and Hydrocarbons

Inner Diameter (mm i.d.)	Length (mm)	Film Thickness (µm)	Temperature Limits (°C)	Part No.
0.32	30		-60 to 250	N9316359
0.53	30		-60 to 250	N9316360

Note: -60 °C is the lowest temperature used on this phase in our lab. Lower temperatures may be used depending on the sample.

Velocity-1, Velocity-5, and Velocity-Wax

PerkinElmer Velocity columns are excellent for standard daily test applications. They combine quality and affordability with reproducible results.

Features and Benefits

- Excellent results for theoretical plates, selectivity, & tailing factor tests
- Robust column cage
- Low baseline noise

Velocity-1 — 100% Dimethyl Polysiloxane

General purpose columns with a highly versatile phase that is extremely rugged, exhibiting long column lifetime, and high operating temperatures. Ideal for the analysis of non-polar petrochemical samples, such as detailed hydrocarbon analysis, hydrocarbon gases, petroleum oxygenates, petroleum aromatics, fuels, waxes, oils, sulfur compounds, mercaptans, and carbon disulfide. It also is an excellent phase for solvents, chemicals, flavors, fragrances, essential oils, air toxins, chlorofluorocarbons, arson analysis, pesticides, and hydrocarbons. Thermal stability up to 350 °C.

Description	Dimensions	Part No.
Velocity-1	15 M x 0.25 mm x 0.25 µm	N9306319
Velocity-1	15 M x 0.25 mm x 1.00 µm	N9306310
Velocity-1	30 M x 0.25 mm x 0.25 µm	N9306312
Velocity-1	30 M x 0.25 mm x 1.00 µm	N9306323
Velocity-1	30 M x 0.32 mm x 0.25 µm	N9306318
Velocity-1	30 M x 0.32 mm x 1.00 µm	N9306321
Velocity-1	30 M x 0.32 mm x 3.00 µm	N9306329
Velocity-1	60 M x 0.25 mm x 0.25 µm	N9306320
Velocity-1	60 M x 0.25 mm x 1.00 µm	N9306328
Velocity-1	60 M x 0.32 mm x 1.00 µm	N9306324

Velocity-5 — 5% Diphenyl and 95% Dimethyl Polysiloxane

This column is ideal for general purpose analysis of drugs, pesticides, hydrocarbons, essential oils and semi-volatiles and solvent impurities. Low polarity phase with thermal stability up to 350°C.

Description	Dimensions	Part No.
Velocity-5	15 M x 0.32 mm x 0.25 µm	N9306325
Velocity-5	30 M x 0.25 mm x 0.25 µm	N9306311
Velocity-5	30 M x 0.32 mm x 0.25 µm	N9306313
Velocity-5	30 M x 0.32 mm x 1.00 µm	N9306316
Velocity-5	30 M x 0.53 mm x 0.50 µm	N9306326
Velocity-5	30 M x 0.53 mm x 1.50 µm	N9306327

Velocity-Wax — Polyethylene Glycol

This column is ideal for intermediate to high polarity compounds. Thermal stability up to 250 °C.

Description	Dimensions	Part No.
Velocity-Wax	30 M x 0.32 mm x 0.25 µm	N9306314
Velocity-Wax	30 M x 0.25 mm x 0.25 µm	N9306315
Velocity-Wax	30 M x 0.32 mm x 0.50 µm	N9306317
Velocity-Wax	30 M x 0.53 mm x 1.00 µm	N9306322





**ROBUST
RELIABLE
REPRODUCIBLE**

Custom Packed Columns

Design your own custom packed column in 3 easy steps:

- Choose your preferred column material (glass or metal)
- Select the length, diameter, phase, solid support, mesh and quantity
- Add your contact information and submit your quote request

It's that easy! We can supply any combination of support and liquid phase listed on our online ordering form. If your laboratory requires something that is not listed on our form, we will make every effort to find a solution to meet your needs.

- Custom packed columns for PerkinElmer, Agilent®, Thermo Scientific®, and other GC instruments
- Over 300+ Stationery Phases
- Over 100+ Solid Supports

To get your custom quote today fill out our online form:

<http://www.perkinelmer.com/tools/custompackedcolumn.aspx>

Replacement Column Sets For Standard Arnel Engineered Analyzers

Why would you compromise your gas chromatography by accepting cheap substitutes when replacing the columns in your Arnel Analyzer? Use only genuine PerkinElmer column sets as replacements to meet your specific chromatographic needs.

Don't see what you need?

Please contact your local PerkinElmer sales representative for replacement column sets for Custom Engineered Arnel Analyzers or for more information about our Arnel Engineered Solutions Analyzers.

Replacement Column Sets for Standard Arnel Refinery Gas Analyzers

Description	For Standard Model	Part No.
Replacement column set for the Arnel RGA	1015	N6107032
Replacement column set for the Arnel RGA	1116	N6107033
Replacement column set for the Arnel RGA	1115	N6107033
Replacement column set for the Arnel RGA	1117	N6107033
Replacement column set for the Arnel RGA	1215	N6107032
Replacement column set for the Arnel RGA	1315	N6107033
Replacement column set for the Arnel RGA	1317	N6107033
Replacement column set for the Arnel RGA	1515	N6107033

Note: Column sets are sold only as spares with an order, or as replacements for installed analyzers.

Replacement Column Sets for Standard Arnel Natural Gas Analyzers

Description	For Standard Model	Part No.
Replacement column set for the Arnel NGA	2001	N6107040
Replacement column set for the Arnel NGA	2002	N6107048
Replacement column set for the Arnel NGA	2003	N6107052
Replacement column set for the Arnel NGA	2006	N6107056
Replacement column set for the Arnel NGA	2008	N6107060
Replacement column set for the Arnel NGA	2101	N6107041
Replacement column set for the Arnel NGA	2103	N6107053
Replacement column set for the Arnel NGA	2106	N6107057
Replacement column set for the Arnel NGA	2108	N6107061
Replacement column set for the Arnel NGA	2201	N6107040
Replacement column set for the Arnel NGA	2203	N6107052
Replacement column set for the Arnel NGA	2206	N6107056
Replacement column set for the Arnel NGA	2208	N6107060
Replacement column set for the Arnel NGA	2301	N6107041
Replacement column set for the Arnel NGA	2303	N6107053
Replacement column set for the Arnel NGA	2306	N6107057
Replacement column set for the Arnel NGA	2406	N6107056
Replacement column set for the Arnel NGA	2501	NR002500
Replacement column set for the Arnel NGA	2503	NR002503

Note: Column sets are sold only as spares with an order, or as replacements for installed analyzers.

Replacement Column Sets for Other Standard Arnel Analyzers

Description	For Standard Model	Part No.
Replacement column set	4001	N6107070
Replacement column set	4002	N6107070
Replacement column set	4003	N6107072
Replacement column set	4004	N6107073
Replacement column set	4005	N6107073
Replacement column set	4012	N6107216
Replacement column set	4013	N6107218
Replacement column set	4016	N6107221
Replacement column set	4017	N6107222
Replacement column set	4019	N6107224
Replacement column set	4020	N6107075
Replacement column set	4021	N6107225
Replacement column set	4022	N6107076
Replacement column set	4024	N6107226
Replacement column set	4025	N6107208
Replacement column set	4027	N6107208
Replacement column set	4028	N6107208
Replacement column set	4029	N6107208
Replacement column set	4030	NR004030
Replacement column set	4031	NR004031
Replacement column set	4032	N6107227
Replacement column set	4033	N6107228
Replacement column set	4034	N6107229
Replacement column set	4035	N6107230
Replacement column set	4036	N6107230
Replacement column set	4037	N6107232
Replacement column set	4038	NR004038
Replacement column set	4040	NR004040
Replacement column set	4041	NR004041
Replacement column set	4043	NR004043
Replacement column set	4044	NR004044
Replacement column set	4045	NR004045
Replacement column set	4046	NR004046
Replacement column set	4083	NR004083
Replacement column set	4086	NR004086
Replacement column set	4087	NR004087
Replacement column set	4227	N6107208
Replacement column set	4425	N6107208
Replacement column set	4428	N6107208
Replacement column set	4429	N6107208
Replacement column set	4430	NR004030
Replacement column set	4431	NR004031
Replacement column set	4438	NR004038
Replacement column set	4629	NR004229

Note: Column sets are sold only as spares with an order, or as replacements for installed analyzers.

Unless otherwise noted all columns are available for the Clarus, AutoSystemXL and AutoSystem GC.

Calibration Gas Blends

Our calibration gas blends were formulated to be used exclusively in our Refinery and Natural Gas Analyzers. These are the same test gases that are used in the verification and validation processes that take place at our factory. Please contact your local PerkinElmer sales representative for more information about the composition of the gas blends.

Description	Part No.
RGA Calibration Blend With Syringe Adapter; 14L Cylinder @ 120 psi	N6107198
RGA Calibration Blend Without Adapter; 14L Cylinder @ 120 psi	N6107199
NGA Calibration Blend With Syringe Adapter; 14L Cylinder @ 240 psi	N6107200
NGA Calibration Blend Without Adapter; 14L Cylinder @ 240 psi	N6107201

Arnel

We have an APP for that!

The **Arnel Group** within PerkinElmer Gas Chromatography is responsible for providing complete engineered solutions for a wide array of often encountered analytical problems. Do you have the need for a custom solution to perform ASTM or other regulated methods in your lab? Some of the types of analyzers Arnel has supplied are found in the list of categories shown here:

Natural Gas / NGL

Condensates

LPG

Refinery / Light Hydrocarbon Gas

Olefins

Aromatics

Oxygenates

Industrial Solvents

Naphthas

Gasoline

Distillates

Lube Oils / Waxes

Crude Oils

Asphalt

Bulk Gases

Trace Gases

TOGA

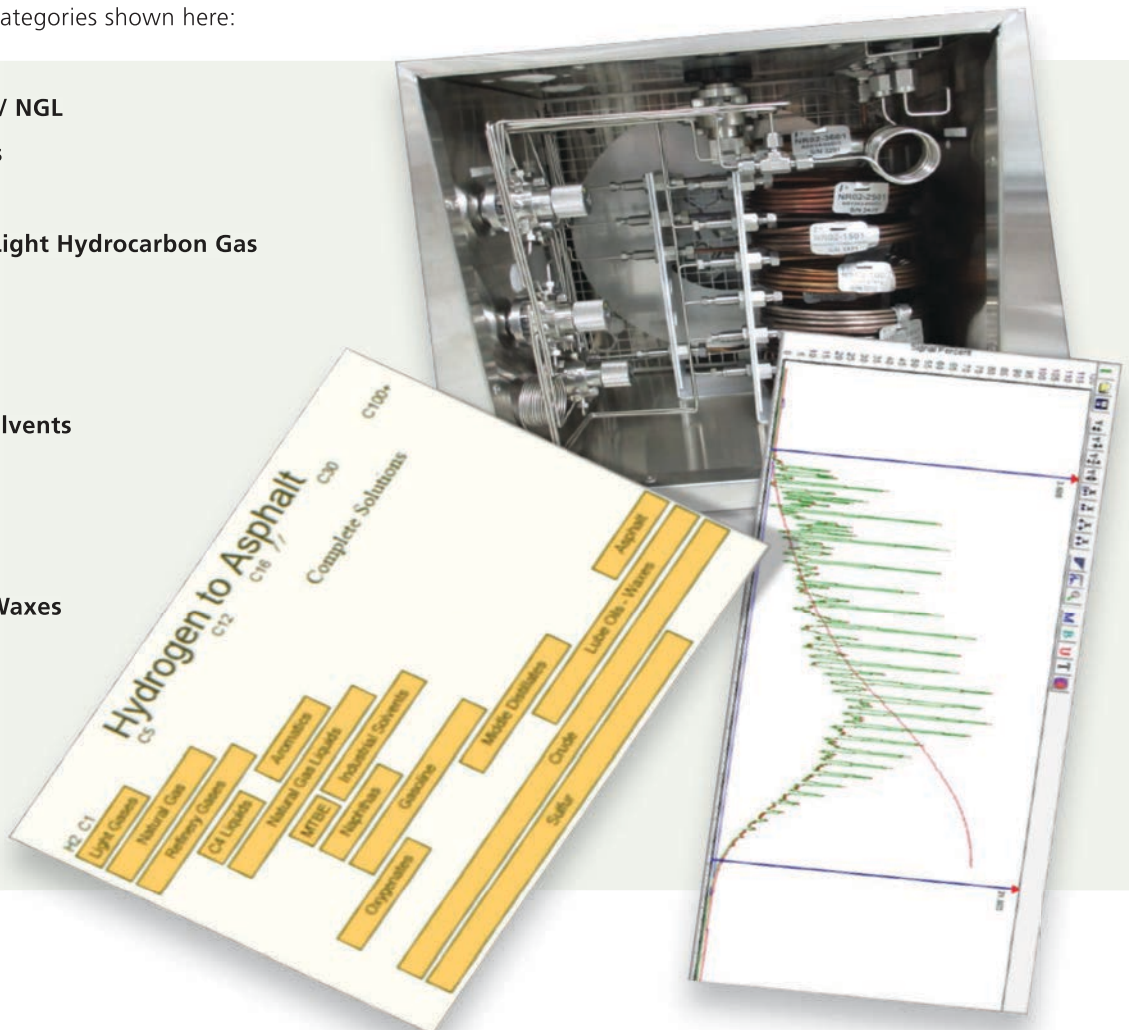

Ask Your Local PerkinElmer Sales Rep about our Product Catalog!

SilTite™ metal ferrules

Provide a continuous leak-free connection and are perfect for connecting your column to a GC/MS.

The SilTite™ metal ferrule and nut are manufactured from the same material and therefore expand and contract at the same rate, eliminating the need to retighten – even after temperature cycling. The base of the SilTite™ ferrule forms a perfect seal with the MS interface, ensuring a leak-free connection. SilTite™ metal ferrules have a temperature limit well above the temperature capacity of the injector, MS interface or GC oven.



Description	Hole Size	Part No.
SilTite™ Ferrules Starter Kit*	0.4 mm	N9306090
SilTite™ Ferrules Starter Kit*	0.5 mm	N9306091
SilTite™ Ferrules Starter Kit*	0.8 mm	N9306092
SilTite™ Ferrules (pkg. 10)	0.4 mm	N9306093
SilTite™ Ferrules (pkg. 10)	0.5 mm	N9306094
SilTite™ Ferrules (pkg. 10)	0.8 mm	N9306095
SilTite™ Nuts (pkg. 5)		N9306096

* Kits include 2 nuts and 10 ferrules

Capillary column ferrules

Graphite

Ferrule of choice for high-temperature applications up to 450 °C. Graphite seals easily and does not stick to glass columns.

Graphite/Vespel®

15% graphite / 85% polyimide ferrule recommended for use with GC/MS systems. Temperature limit is 350 °C.

Vespel®

Not reusable. Not recommended for fused silica capillary columns. Use these ferrules on 1/16 inch metal tubing and glass-lined receivers. Temperature limit is 350 °C.

Size	Column i.d. / Ferrule i.d.	Graphite Part No.	Graphite/Vespel® Part No.
1/16 in	0.18 – 0.25 mm / 0.4 mm		09920104
1/16 in	0.18 – 0.32 mm / 0.5 mm	09903700	09920105
1/16 in	0.18 – 0.32 mm / 0.5 mm**	N9306001	N9306000
1/16 in	0.18 – 0.53 mm / 0.8 mm	09920141	09920107
1/8 in	0.18 – 0.53 mm / 1.0 mm	09903394	
1/8 in	0.18 – 0.32 mm / 0.5 mm**	09903395	
1/8 in	0.18 – 0.32 mm / 0.5 mm	09903981	

** 2-hole

Wide-bore adapter kit

Contains all the parts necessary to adapt to packed column injectors quickly and easily for use with wide-bore capillary columns.

Includes 0–20 mL/min flow controller element, wide-bore adapter with 1/16 inch fitting, wide-bore glass liner and column support hanger.

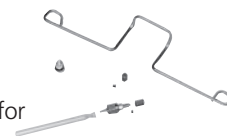

Description	Part No.
Wide-Bore Adapter Kit	N6120001

Universal connectors



Dimension	Part No.
Universal Connector (pkg. 5)	N9302149
Metal Universal Connectors: 0.25 mm i.d. (pkg. 10)	N9301167
Universal Y Splitter (pkg. 1)	N9303448
Polyimide Sealing Resin (5 g)	N9301343
Undeactivated Presstight Column Connectors (pkg. 5)	N9303962

Wafer scribes

The PerkinElmer ceramic wafer scribe is inexpensive and ideal for cutting polyimide fused silica capillary columns and guard columns. The scribe is easy to hold and simple to use. All four sides can be used as a cutting tool.



Dimension	Part No.
Wafer Scribes (pkg. 10)	N9301376

Swagelok™ Fittings











Swagelok fittings from PerkinElmer are available in brass and stainless steel.

The patented advanced-geometry back ferrule design provides a leak-tight tube connection on all Swagelok™ stainless steel tube fittings, in sizes 1/4 to 1/2 in., and 6 to 12 mm. Leak-tight seals that will withstand high-pressure, vibration, vacuum and temperature changes depend upon close tolerances and consistent, exacting quality control in conjunction with good design principles.

Features and Benefits

- Ease of installation
- Back ferrule axially advances the front ferrule
- Vibration fatigue resistance
- Wide variety of configurations

Swagelok™ Fittings

Product	Qty.	Size	Brass Part No.	Stainless Steel Part No.
Bulkhead Adapter 	1	1/4 in. to 1/4 in. tube		N9301267
Back Ferrule 	pkg. 5	1/16 in.	N9300040	N9300042
		1/8 in.	N9300036	N9300038
		1/4 in.	N9300030	N9300032
Cross Union 	pkg. 1	1/8 in.	N9301259	
Front Ferrule 	pkg. 5	1/16 in.	N9300041	N9300043
		1/8 in.	N9300037	N9300039
		1/4 in.	N9300031	N9300033
Male Adapter Tube to Pipe 	pkg. 1	1/4 in. tube to 1/8 in. NPT	N9301266	
Male Connector 	pkg. 1	1/8 in. to 1/8 in. NPT	N9301253	
		1/8 in. to 1/4 in. NPT	N9301254	
		1/4 in. to 1/8 in. NPT	N9301255	
		1/4 in. to 1/4 in. NPT	N9301269	
Nut 	pkg. 5	1/16 in.	N9300058	N9300059
		1/8 in.	N9300056	N9300057
		1/4 in.	N9300054	N9300055
Plug 	pkg. 1	1/16 in.		N9300053
		1/8 in.	N9300060	N9300061
		1/4 in.	N9301268	N9301233
Union 	pkg. 2	1/16 in.	N9300048	N9300049
		1/8 in.	N9300046	N9300047
		1/4 in.	N9300044	
Union Tee 	pkg. 1	1/16 in.	N9301221	
		1/8 in.	N9301222	
		1/4 in.	N9301223	
Reducing Union 	pkg. 1	1/8 in. to 1/16 in.	N9300051	N9301225
		1/4 in. to 1/8 in.	N9300050	N9301226
		1/4 in. to 1/16 in.	N9301227	

REFINE YOUR GC PATH

Swafer Micro-Channel Wafer Technology

PerkinElmer's Swafer™ micro-channel wafer technology is an innovative and user-friendly approach for flowswitching and splitting applications. It delivers unparalleled hardware and application flexibility, expanding the capabilities of capillary gas chromatography (GC).



Features and Benefits:

- Allows you to tackle difficult or otherwise impossible separations, delivering richer sample information which was previously unattainable
- User-friendly design and user-defined oven position allow easy setup and configuration changes, without requiring service intervention
- Complete independence of the column from injectors or detectors lets you combine injection techniques (headspace, thermal desorption, liquid, ect.), based on sample requirements
- 15 user-interchangeable configurations deliver over 18 possible modes of operation for unparalleled application flexibility
- Can be used on any Clarus 580/500 or 680/600 GC with programmable pneumatic control (PPC)
- Vent unwanted solvent or other large peak from chromatogram
- Tweak the column polarity with serial column for difficult separations

Swafer Kits for New Clarus GC Systems

Description	Part No.
D-Swafer Complete Kit – for Clarus GC units only (for Clarus 680/580 GCs with PPC) Includes all required installation hardware user guides, and the D-Swafer.	N6520273
S-Swafer Complete Kit – for Clarus GC units only (for Clarus 680/580 GCs with PPC) Includes all required installation hardware, user guides, and the S-Swafer.	N6520272

Swafer Kits and Accessories for Existing Clarus GC Systems

Description	Part No.
Micro-Channel Kit for Existing Clarus 680/600/580/500 GC with PPC. Includes all hardware required to install a Swafer. The Swafer and installation are not included and must be purchased separately.	N6520270
Micro-Channel Kit for Existing Clarus 680/600/580/500 GCs with PreVent currently installed. If PreVent is already included in the GC configuration, this hardware kit provides the additional parts required to install a Swafer. The Swafer and installation are not included and must be purchased separately.	N6520271
D-Swafer Dean's Switch (Swafer only)	N9306251
S-Swafer Splitter (Swafer only)	N9306262

HOW CAN THE SWAFER HELP YOU?

Enhanced Sample Information

Solvent venting	Vent unwanted solvent or other large peak from chromatogram	D-Swafer S-Swafer
Detector switching	Switch between your detectors of choice anytime during the run or between injections	D-Swafer
Column switching	Make your GC more flexible by choosing which column should be used to chromatograph the injected sample	D-Swafer
Heartcutting	Cut your chromatogram and analyze the cut on a different column for a better separation	D-Swafer
Polarity tuning	Tweak the column polarity with serial column for difficult separations	D-Swafer S-Swafer
Column selection	Better utilize large and expensive detectors by choosing which of the two columns to monitor	D-Swafer
Carrier-gas swapping	Use a different carrier gas in the injector or sampling system from that used for the chromatography	D-Swafer
Peak attenuation	Analyze a wide dynamic range by diluting portions of your chromatography	D-Swafer
Splitting	Split your chromatography between up to four channels (detectors, sniffer ports, etc.) for additional sample information	S-Swafer

Throughput and Maintenance

Column backflushing	Remove unwanted compounds from the column after the analytes have eluted	D-Swafer S-Swafer
MS isolation	Perform your MS, column and inlet maintenance without venting for less downtime	D-Swafer S-Swafer
Retention-gap purging	Remove large amounts of solvent with cold on-column injection	D-Swafer
Inlet selection	Automate your inlet choices (headspace, thermal desorption, liquid autosampler, etc.) between injections	D-Swafer
Injector maintenance or enhanced large volume injection	Enable injector septa or liner exchange while the system is still active Prevent solvent vapor from entering column and detector during injector purging	D-Swafer S-Swafer

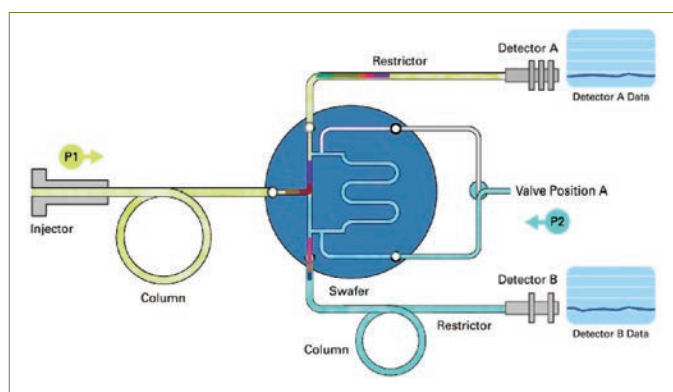

Heartcutting (D-Swafer) allows separation of selected peaks within a complex sample matrix.

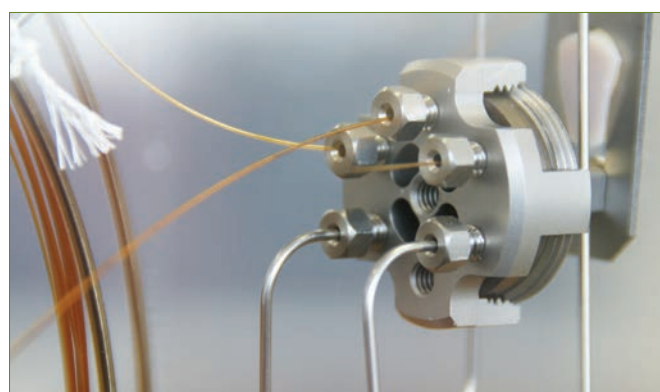

Swafer can be installed in any Clarus S80/S00 or 680/600 GC with programmable pneumatic control (PPC).

Manual Gas Control

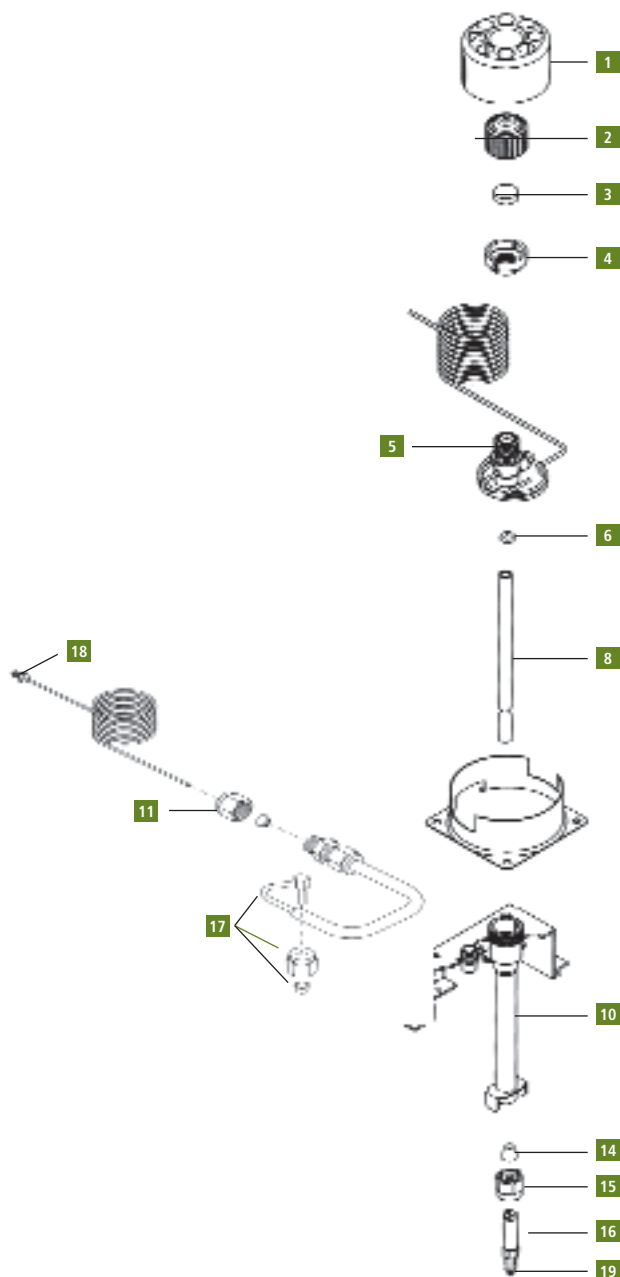

Injector Replacement Parts

Component	Part No.
1 Injector Cover	N6101482
2 Septum Cap	N6100153
3 PerkinElmer Green Injection Septum (pkg. 50)	N6621028
4 Injector Top Nut	N6101358
5 Injector Head	N6100158
O-Ring, Silicone for Glass Liner (pkg. 10) Maximum injector temperature 250 °C.	N6101374
O-Ring, Graphite for Glass Liner (pkg. 5) Maximum injector temperature 450 °C.	N6101378
6 O-Ring, KALREZ® for Glass Liner (pkg. 1) Maximum injector temperature 450 °C.	N9302782
O-Ring, Viton® for Glass liner (pkg. 1) Maximum injector temperature 250 °C, recommended for use with Mass Spec. ships with instrument	N9302783
Quartz Liner (2 mm) for Splitless Operation	N6121002
Quartz Liner (4 mm) for Split Operation or Large Volume Splitless Injection	N6121001
Glass Liner (2 mm) for Splitless Operation	N6101372
Glass Liner (4 mm) for Split Operation	N6101052
8 Deactivated Liner for Splitless Operation 2 mm, packed with wool. (pkg. 5)	N6121021
Deactivated Liner for Split Operation 4 mm, packed with wool. (pkg. 5)	N6121020
Deactivated Unliner 4 mm, packed with wool. (pkg. 5)	N6121022
10 Injector Body	N6100047
11 1/8 in. Swagelok™ Nut Brass (pkg. 5)	N9300056
12 Restrictor*	N6101034
13 1/8 in. Graphite/Vespel Ferrule (pkg. 10)*	09920301
14 1/4 in. Graphite Ferrule (pkg. 10)	09920140
15 1/4 in. Swagelok Nut, Stainless Steel (pkg. 5)	N9300055
16 Injector Adapter	N6100157
17 Charcoal Trap	N6100275
Charcoal Trap for PPC Version**	N6100331
18 Split Vent Tube	N6100159
19 Column Nut 1/16 in. Long length for reversed ferrule (pkg. 5)	09903392

** Not shown

Miscellaneous Accessories

Component	Part No.
2 oz. Replacement Charcoal (30/60 mesh)	03300904
Column Ferrule Graphite/Vespel	09920105
Liner Removal Tool	N6100102
Merlin Microseal Adapter Kit Includes: 2 Merlin Microseal septa, 1 nut, and 1 injection port adapter	N9303344
Merlin Microseal Septa	N9303345
Zero Dilution Liner (Inner)	N1011446
Zero Dilution Liner (Outer)	N1011445

Split/Splitless Injector Add-On Kits

Capillary Injector with PPC

Kit includes split/splitless injector with programmable pneumatic control for carrier gas, split vent, heater, sensor, and heater block. The AutoSystem XL must be PPC™ ready. If not, a PPC upgrade kit (N6120146) is required. Installation by PerkinElmer Service is required, but not included.

Voltage	Part No.
120 V	N6120138
240 V	N6120139

Complete Capillary Injector Add-On Kits

Kit includes split/splitless injector in module with heater and sensor, 0-60 psi pressure regulator, and transducer for pressure readout. For manual gas control.

Voltage	Part No.
120 V AutoSystem	N6120009
240 V AutoSystem	N6120022
120 V Clarus	N6520012
230 V Clarus	N6520013

Dual Capillary Column Adapter Kit

Kit includes all necessary hardware to install two capillary columns to a capillary injector. Note: kit does not include appropriate 1/8 in. 2-hole ferrule. (See page 200) For manual gas control.

Voltage	Part No.
120 V	N6120050

Split/Splitless Injector Starter Kit for Manual Gas Control

Includes: 2 mm i.d. quartz liner, 4 mm i.d. quartz liner, silicone O-Rings (10), green septa (50), 0.5 mm graphite ferrules (10), 0.8 mm graphite ferrules (10), 1/16 in. stainless steel nuts (5), untreated quartz wool, packing rod, and wafer scribes (10).

Voltage	Part No.
Split/Splitless Injector Starter Kit for Manual Gas Control	N6120101

Add-On Kits

Packed Column Injector Kit with Manual Pneumatics

Includes: complete injector assembly with heater and sensor, 0-100 mL flow controller, and column head pressure gauge for installation into the AutoSystem.

Voltage	Part No.
120 V*	N6120007
240 V*	N6120023

Packed Column Injector Kit with PPC

The kit includes complete injector assembly with programmable pneumatic control, heater, sensor, and heater block. The GC must be PPC™ ready. If not, a PPC upgrade kit (N6120146) is required.

Voltage	Part No.
120 V*	N6120136
240 V*	N6120137

Packed Column Injector Kit with Screen Readout and Manual Pneumatics

Includes: complete injector assembly with heater and sensor, 0-100 mL flow controller and column head pressure gauge, and transducer for screen readout of column carrier flow.

Voltage	Part No.
120 V* AutoSystem	N6120008
240 V* AutoSystem	N6120025
120 V* Clarus	N6520010
230 V* Clarus	N6520011

Packed Column Injector Kit AutoSystem XL and Clarus

The kit includes complete injector, heater, sensor, and heater block. (Does not include pneumatics.)

Voltage	Part No.
120 V*	N6120071
240 V*	N6120072

Packed Column Injector Starter Kit

Includes glass liner, needle guide, green septa (50), untreated quartz wool, and packing rod.

Voltage	Part No.
Packed Column Injector Starter Kit	N6120100

*Service installation suggested

Injector Replacement Parts

Description	Part No.
1 Septum Cap	N6100153
2 PerkinElmer Green Injection Septum (50/pack)	N6621028
3 Needle Guide	N6101050
4 Glass Liner	N6101048
4 Quartz Liner	N6121000
5 Packed Injector Assembly	N6100048

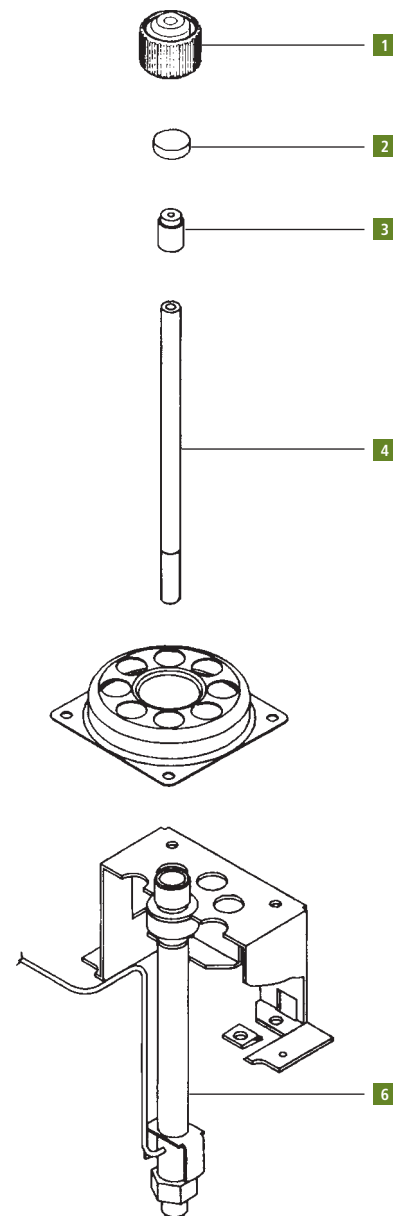

Miscellaneous Accessories

Injector/Detector Adapter 1/4 in.

Adapter fits on injector and detector outlet (inside oven) for use with 1/4 in. columns.

Description	Part No.
Injector/Detector Adapter 1/4 in.	00080100

Liner Removal Tool

Allows easy removal of glass liners from injector port.

Description	Part No.
Liner Removal Tool	N6100102

Silanized Glass Wool

Packing for wide-bore glass liners.



Description	Part No.
Silanized Glass Wool (2 oz.)	03300905

Wide-Bore Adapter Kit

0.53 Capillary Column Adapter Kit

The AutoSystem Wide-Bore Adapter Kit allows conversion of the packed inlet for 0.53 mm capillary column operation. The kit includes 0-20 mL flow control element, wide-bore adapter with 1/16 in. fitting, wide-bore glass liner, and column support hanger. Can be used in both on-column and off-column modes of operation.

Description	Part No.
0.53 Capillary Column Adapter Kit	N6120001

Convenient GC/MS Consumable Kits

Description	Part No.
GC/MS PSS Injector Starter Kit	N6100447

Contents	Pkg.	Qty.	Part No.
5.0 µL Autosampler Syringe	1		N6101390
Vial Locator (dongle)	2		N6101182
PSS Injector Viton o-rings (250 deg)	10	1	N6101747
PSS Injector Kelrez o-rings (350 deg)	1	10	09921004
PSS Split/Splitless Injector, 2 mm, No Wool	2		N6121004
Graphite/Vespel Ferrules, for 0.25 mm Columns	10	2	09920104
PerkinElmer Green Speta (50 pieces)	1		N6621028
Marathon Filament	1		N6470012
Aluminum Oxide Powder (3 oz)	1		04190197

Description	Part No.
GC/MS CAP Injector Starter Kit	N6100448

Contents	Pkg.	Qty.	Part No.
5.0 µL Autosampler Syringe	1		N6101390
Vial Locator (Dongle)	2		N6101182
CAP Injector Viton o-rings (250 deg)	10		N9302783
CAP Injector Kelrez o-rings (350 deg)	10		N9302782
CAP Split/Splitless Injector, 4 mm, No Wool	2		N6121004
Graphite/Vespel Ferrules, for 0.25 mm Columns	10	2	09920104
PerkinElmer Green Speta (50 pieces)	1		N6621028
Marathon Filament	1		N6470012
Aluminum Oxide Powder (3 oz)	1		04190197

POC Replacement Parts

Components	Part No.
1 Septum Cap	N6100153
2 PerkinElmer Green Injection Septum (50/pack)	N6621028
3 Needle Guide	N6101702
4 Liner/Hour Glass	N6101703
5 Body Assembly	N6100256

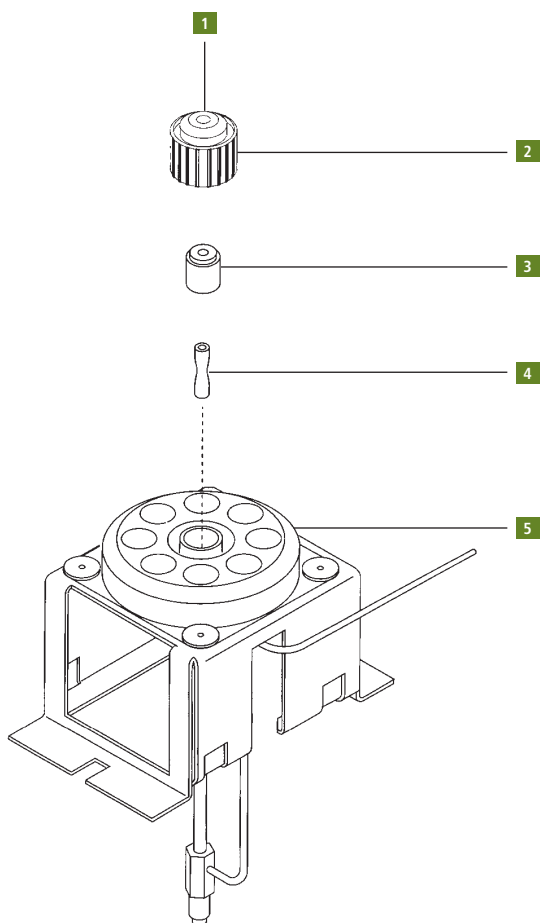

Programmed-Temperature On-Column Injector System

Packed Column Injector Kit with Manual Pneumatics

Programmed-Temperature On-Column (POC) Inlet is designed to be used with fused-silica capillary columns. The sample is injected onto the column while the inlet is cool. After the injection, the inlet begins to heat. This delay in heating avoids the flash vaporization associated with a normal injection. This explosive vaporization can cause thermal breakdown and/or discrimination of certain analytes, which can be avoided by using the POC.

The POC Injector is best used to achieve recovery of compounds of greater than C₆₀ (e.g., polywaxes). The POC utilizes flow control, producing the best recovery out to C₁₀₀ or greater.

POC Injector with Manual Flow Controller and Head Pressure Gauge

Kit includes all necessary hardware to install injector into AutoSystem Series or Clarus Series.

Voltage	Part No.
120 V*	N6120076
240 V*	N6120077

POC Injector with Manual Flow Controller and Head Pressure Gauge with Flow Readout on Screen

Kit includes all necessary hardware to install injector into AutoSystem Series or Clarus Series.

Voltage	Part No.
120 V*	N6120082
240 V*	N6120083

POC Injector with PPC Add-On Kit

Kit includes injector with programmable pneumatic control, heater, sensor, and heater block. The AutoSystem XL or Clarus GC must be PPCTM ready. If not, a PPC upgrade kit (N6120146) is required. Installation by PerkinElmer Service is required, but not included.

Voltage	Part No.
120 V*	N6120142
240 V*	N6120143

POC Injector Starter Kit

Includes: needle guides (5), universal connectors (5), 0.53 mm i.d. deactivated fused silica (5 m), 1/16 in. stainless steel nuts (5), 0.8 mm graphite ferrules (10), green septa (50), and wafer scribes (10).

Voltage	Part No.
POC Injector Starter Kit	N6120098

* Service installation suggested.

Programmed-Temperature Split/Splitless Injector System

PSS Injector Add-On Kits with Manual Pneumatics

The programmed-temperature split/splitless (PSS) inlet allows accurate sample delivery to a capillary column. The PSS allows the analysis of thermally labile compounds, while eliminating the discrimination of high-boiling compounds. One of the major advantages of the PSS is that any nonvolatile material will remain in the inlet liner and not on the front of the column.

PSS with pneumatics and pressure readout on screen. Kit includes all necessary hardware to install injector into GC.

Voltage	Part No.
120 V* AutoSystem	N6120074
240 V* AutoSystem	N6120075
120 V* Clarus	N6520014
230 V* Clarus	N6520015

PSS Injector with PPC

Kit includes injector with programmable pneumatic control, heater, sensor, and heater block. The GC must be PPC™ ready. If not, a PPC upgrade kit (N6120146) is required.

Voltage	Part No.
120 V*	N6120140
240 V*	N6120141

PSS Injector Starter Kit

Includes: universal connectors (5), 0.53 mm i.d. deactivated fused-silica (5 m), 2 mm i.d. quartz liner, 1 mm i.d. quartz liner, glass hourglass liner, 1/16 in. stainless steel nuts (5), 0.5 mm i.d. graphite ferrules (10), 0.8 mm i.d. graphite ferrules (10), Viton® O-Rings (6), graphite O-Rings (5), untreated quartz wool, wafer scribes (10), and green septa (50).

Description	Part No.
PSS Injector Starter Kit	N6120102

Zero Dilution Liners

Used together as set.

Description	Part No.
Inner Liner	N1011446
Outer Liner	N1011447

* Service installation suggested.

PSS Replacement Parts

Components	Part No.
1 Septum Cap	N6100153
2 Injector Cover	N6101482
3 PerkinElmer Green Injection Septum (pkg. 50)	N6621028
4 Trap, Charcoal – non PPC version PPC version (not shown)	N6100275
5 Nut	N6101705
6 Septum Purge	N6100260
O-Ring Viton (pkg. 10) max. temp 250 °C, recommended for use with mass spec. Shipped with instrument.	N6101747
7 O-Ring KALREZ® (pkg. 1) max. temp. 450 °C	09921004
O-Ring Graphite (pkg. 5) max. temp. 450 °C	N6101751
Quartz Liner, 2 mm Split Mode Shipped with instrument.	N6121004
8 Quartz Liner, 1 mm Splitless Mode	N6121006
On-column liner	N6101539
9 Body Assembly	N6100261
10 Ferrule 1/8 in. x 1/16 in. (pkg. 10)	09920301
11 Nut 1/8 in.	09903128
12 Split Vent Line	N6100159
13 Purge Restrictor	N6101034
14 Nut	09903392

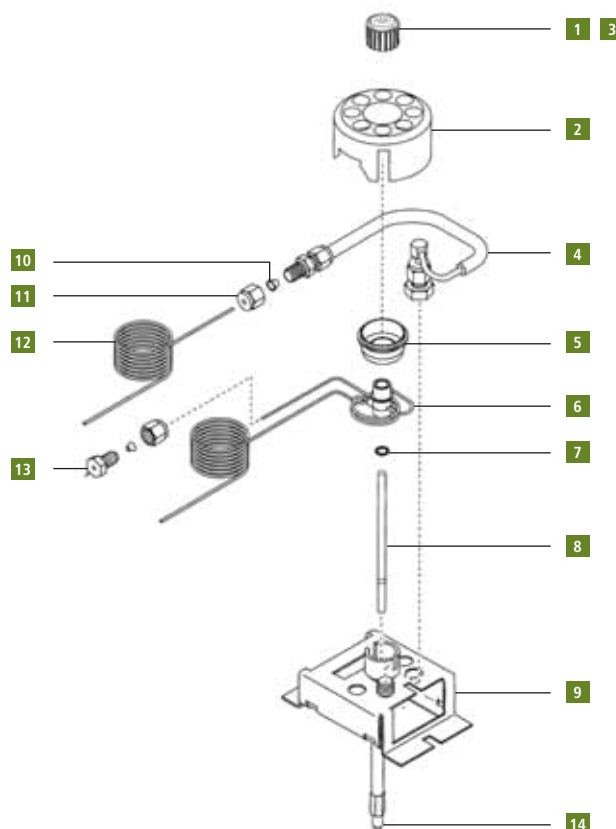

Glass Inlet Liners









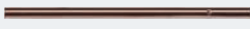

Inlet liners for split injection have mixing chambers with tortuous flow paths to allow full vaporization of the sample. Deactivating the surface of these liners prevents active compounds from degrading. Packing the liner with wool will trap non-volatile residue and prevent column contamination when analyzing dirty samples.

Inlet liners for splitless injection are generally designed as straight tubes, although new designs such as the gooseneck will help contain the sample in the injector. Packing these liners with wool will also help trap non-volatile residue and prevent column contamination.

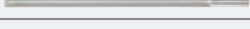

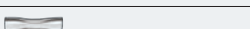



Capillary Split/Splitless Injector Liners

	Description	ID mm	OD mm	Length mm	Pkg	Part No.
	Split Glass Liner Siltek Deactivated Surface Liner (with wool) – Universal liner for general purpose analyses. Surface provides inertness over a wide sample pH range. Wool can be adsorptive if fibers are broken	4	6.2	92.1	5	N6121020
	Split Glass Liner (with wool) – Universal liner for general purpose analyses	4	6.2	92.1	5	N6502009
	Split Siltek Deactivated Glass Liner (with wool) – Universal liner for general purpose analyses. Deactivated surface provides minimal bleed and inertness over a wide sample pH range	4	6.2	92.1	5	N6502010
	Clarus Cup Split Glass Liner – Good for both high and low molecular weight compounds. Sample vaporization is aided by tortuous flow path and minimizes molecular weight discrimination. Difficult to clean	4	6.2	92.1	5	N6502011
	Clarus Cycloplitter Glass Liner – Patented cylindrical design for dirty samples, easy to clean and allows many injections before cleaning is required. Not recommended for large volume injections	4	6.2	92.1	5	N6502012
	Unliner Deactivated Glass Liner (with wool) – Universal liner for general purpose analyses	4	6.2	92.1	5	N6121022
	Clarus Splitless Glass Liner – Low volume sample analyses, beneficial with headspace and purge/trap	1	6.2	92.1	5	N6502006
	Quartz Liner for Splitless Operation (ships with instrument) – Standard injector liner	2	6.2	92.1	1	N6121002
	Glass Liner for Splitless Operation – Universal liner for general purpose analyses	2	6.2	92.1	1	N6101372
	Deactivated Glass Liner for Splitless Operation (with wool) – Good for analyses of trace samples	2	6.2	92.1	5	N6121021
	Siltek Deactivated Liner (with wool) for Splitless Operation – Optimum sample dispersion for active samples. Surface provides inertness over a wide sample pH range. Wool can be adsorptive if fibers are broken	2	6.2	92.1	5	N6502004
	Quartz Liner for Split Operation – Good for large volume injection samples	4	6.2	92.1	1	N6121001
	Glass Liner for Split Operation – Universal liner for general purpose analyses	4	6.2	92.1	1	N6101052
	Siltek Deactivated Double Gooseneck Glass Liner (with wool) – Optimum sample dispersion for active samples. Decreases breakdown of active compounds such as endrin and DDT. Chamber contains sample vaporization cloud. Not suitable for PPC systems	4	6.2	92.1	5	N6502003
	Cyclo Double Gooseneck Liner for Split Operation – Cylindrical design for large volume and trace dirty samples. Decreases injection port discrimination. Cannot be packed with wool and more difficult to clean	4	6.2	92.1	5	N6502005
	Zero Dilution Glass Outer Liner – Ideal for trace HS work. Use in conjunction with N1011446	2	6.3	90	1	N1011445
	Zero Dilution Glass Inner Liner – Ideal for trace HS work. Use in conjunction with N1011445		2	73	1	N1011446

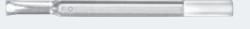

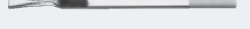

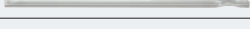

Programmed Temperature Split/Splitless (PSS) Injector Liners

	Description	ID mm	OD mm	Length mm	Pkg	Part No.
	Quartz Liner for Splitless operation (ships with instrument) – Excellent liner for low volume analyses	1	4	86.2	1	N6121006
	NEW! Siltek Deactivated Glass PSS Liner – Used for low volume trace sample analyses	1	4	86.2	5	N6502000
	Quartz Liner for Split operation (ships with instrument) – Approved PerkinElmer standard injector liner	2	4	86.2	1	N6121004
	NEW! Siltek Deactivated Glass Liner for Split operation (with wool) – Maximum inertness and packed with wool gives optimum sample dispersion. Surface provides inertness over wide sample pH range. Wool can be adsorptive if fibers are broken	2	4	86.2	5	N6502001
	NEW! Siltek Deactivated Glass Liner for Split operation – Max. inertness gives optimum sample dispersion. Deactivated surface provides minimal bleed and inertness over a wide sample pH range	2	4	86.2	5	N6502002
	Zero Dilution Outer Liner –Use in conjunction with N1011446	2.8	4	83	1	N1011447
	Zero Dilution Inner Liner –Use in conjunction with N1011447		2	73	1	N1011446
	On-column Glass Liner	2.4	4	86.2	1	N6101539
	Liner/Hour Glass for POC Injector	2.4	4	19.05	1	N6101703
	Quartz Split Liner with Silanized Glass Wool	2	4	86.2	1	N6121008
	Quartz Split Liner with Silanized Glass Wool	2	4	86.2	5	N6121009

Packed Column Injector Liners

	Description	ID mm	OD mm	Length mm	Pkg	Part No.
	Drilled Uniliner (hole on top) – Excellent liner for high sample recovery and linearity, recommended for aqueous injections. Good for PPC equipped GCs	4	6.2	92.1	5	N6121022
	NEW! Drilled Uniliner (hole on bottom) – Recommended for analysis in which compounds of interest could be affected by a tailing solvent peak. Good for PPC equipped GCs	4	6.2	92.1	5	N6502013
	NEW! Gooseneck Drilled Uniliner (hole on top) – Use for trace, active samples, high recovery and linearity	4	6.2	92.1	5	N6502014
	NEW! Gooseneck Drilled Uniliner (hole on bottom) – Use for trace, active samples, high recovery and linearity	4	6.2	92.1	5	N6502015
	NEW! Open Top Uniliner (with wool) – Packed with fused silica wool, highly recommended for high molecular weight active samples. The fused silica wool traps dirt and sample residue	4	6.2	92.1	5	N6502016
	NEW! Cyclo Uniliner – Cylindrical design for high molecular weight samples provides an excellent vaporization surface. Spiral traps dirt reducing further residue sample interaction	4	6.2	92.1	5	N6502017
	Wide-Bore Column Glass Liner	6	4	92.1	1	N6101375
	Wide-Bore Column On/Off Quartz Liner	6	4	92.1	1	N6121003

Colored Injector Liners

	Description	ID mm	OD mm	Length mm	Pkg	Part No.
	PSS deactivated glass liners with deactivated wool. Narrow bore and quartz wool increase volatilization and reproducibility	2	4	86.2	5	N9306232
	Capillary splitless deactivated glass liners with deactivated wool	4	6.2	92.1	5	N9306233
	Capillary splitless deactivated glass liners with deactivated wool	4	6.2	92.1	1	N9306234
	Capillary splitless deactivated glass liners with deactivated wool	4	6.2	92.1	5	N9306235
	Capillary splitless deactivated glass liners with deactivated wool. Quartz wool is used to fully vaporize the sample	4	6.2	92.1	5	N9306236
	PSS Splitless deactivated glass liners with deactivated wool 5/pk	1.25	4	86.2	5	N9306237

AUTOSAMPLER AND MANUAL SYRINGES



New Blue Barrel color design for enhanced sample volume verification (packs of 5 and 10 syringes)

Autosampler Syringes

Syringes from PerkinElmer are individually inspected for accuracy and performance.

Recommended autosampler syringes are available in 0.5, 5 and 50 µL capacities. For routine analyses, the metal plunger in barrel with PTFE-tipped seal is the standard syringe as shipped with each Clarus® GC instrument. Alternative syringes to use are the metal plunger in barrel or the 0.53 mm on-column injection.

Description	Part No.
50 µL Syringe, Metal Plunger 0.63 mm o.d. Needle	N6101760
5 µL Syringe, Metal Plunger PTFE-tipped Seal 0.63 mm o.d. Needle	N6101390
5 µL Syringe, Metal Plunger PTFE-tipped Seal 0.63 mm o.d. Needle BLUE Barrel (pack of 5 syringes)	N6103240
5 µL Syringe, Metal Plunger PTFE-tipped Seal 0.63 mm o.d. Needle BLUE Barrel (pack of 10 syringes)	N6103241
5 µL Syringe, Metal Plunger 0.63 mm o.d. Needle	N6101251
5 µL On-column Syringe Metal Plunger 0.47 mm o.d. Needle	N6101380
0.5 µL Low Injection Volume Syringe, Metal Plunger 0.63 mm o.d. Needle	N6101252
0.5 µL Low Injection Volume Syringe Metal Plunger 0.63 mm o.d. Needle BLUE Barrel (pack of 5 syringes)	N6103242
0.5 µL Low Injection Volume Syringe Metal Plunger 0.63 mm o.d. Needle BLUE Barrel (pack of 10 syringes)	N6103243
0.5 µL Low Injection Volume Syringe, Metal Plunger 0.47 mm o.d. Needle	N6101253

Needles and Syringe Kits

Needle has a 90° bevel. Point style is recommended when the syringe is used for accurate pipetting of liquids. Excellent for mixing standards of very small volume.

Needles

Description	Part No.
Sample Needle w/Fittings	N2936009
Air Guide Needle (62 mm)	N2936000
Bio Compatible Sample Needle w/Tubing Connector	N2936010
Needle (80 mm)	N2936342
Low volume needles	N2931199

Syringe Kits

Dimension	Buffer Tubing	Part No.
100 µL	200 µL	N2936051
250 µL	500 µL	N2936052
500 µL	1,000 µL	N2936053
1,000 µL	2,000 µL	N2936054
2,500 µL	2,000 µL	N2936055

Point Style 2



This is a general purpose point style designed for septum penetration in all chromatographic techniques. The needle has a 22° bevel to minimize coring and needle plugging.

Point Style 3



Needle has a 90° bevel. Point style is recommended when the syringe is used for accurate pipetting of liquids. Excellent for mixing standards of very small volume.

GC Injector Syringes

Features and Benefits

- All PerkinElmer injectors have been tested and optimized for use with a 7 cm needle
- A 7 cm needle is critical to be sure your sample is deposited in the optimal zone

Syringe Capacity	Gauge	Length	Pack Size	Point Style	Part No.
------------------	-------	--------	-----------	-------------	----------

Removable Needle Syringes (RN)

10 µL			1	#2	N9302210
25 µL			1	#2	N9302211
50 µL			1	#2	N9302212
100 µL			1	#2	N9302213

Replacement Needles for RN Syringes

10 µL			1	#2	N9302222
25/50/100 µL	22S	2 in	3	#2	N9302224
250 µL	22S	2 in	3	#2	N9302226

Fixed Needle Syringes

10 µL ³			1	#2	00230523
10 µL ²			6	#2	N9302230
25 µL			1	#2	N9302202
25 µL			1	#3	09904823
50 µL			1	#2	N9302203
50 µL			1	#3	09904941

² Savings based on one-piece price. Savings of 20% reflected in price shown.

³ Standard fitted with 7 cm needle.

11 MM MOLDED GREEN AND ORANGE INJECTION PORT SEPTA



Microsyringes (For Manual Injection)

Syringes are used for accurate and precise liquid delivery. Each syringe is hand-fitted to assure maximum accuracy. Our syringes are composed of glass barrels and precision stainless steel needles. The needle features a blunt tip, required for use with a Rheodyne injector.

Description	Part No.
10 µL Syringe	09904937
25 µL Syringe	09904823
50 µL Syringe	09904941
100 µL Syringe	09904822
Rheodyne 22-gauge Blunt Needle with Luer Hub	09904943

Merlin MicroSeal™ Septum

The Merlin MicroSeal™ septa is a unique replacement septa employing a two-step sealing system and an advanced elastomer material.



Because the syringe needle does not pierce the septa, there is no debris and ghost peaks are greatly reduced. The MicroSeal™ septa also reduces the incidence of bent syringe needles and liner contamination. Usable in either manual or autosampler applications, this septa can improve your productivity and run reliability. Designed to be used with 23 gauge straight needle syringes. Pressure ranges from 4 to 100 psi and injection port temperatures up to 325 °C.

Description	Part No.
Merlin MicroSeal™ Septum Kit Includes: Injector Port Adapter, 2 Septa and 1 Nut	N9303344
Merlin MicroSeal™ Septum	N9303345

Injector Septa

- PerkinElmer Green Injection septum, extremely low bleed over a wide range of inlet temperatures — 100 °C to 350 °C. Easier needle penetration and high puncture tolerance make this septum ideal for autosamplers. This septum is already conditioned and ready to use
- BTO™ (Bleed Temperature Optimized) injector septa, 11 mm diameter. Maximum recommended operating temperature 300 °C
- PTFE/Silicone injector septa, 11 mm diameter

Description	Pkg.	Part No.
PerkinElmer Green Injection Septum	50	N6621028
Low Bleed Injector Septa	25	N9303343
PTFE/Silicone Injector Septa	50	00090652
Green Injection Port Septa	10	N9306218
Green Injection Port Septa	50	N9306219
Orange Injection Port Septa	50	N9302972

Green — Septa rated to 400 °C. The advanced green septum was created to combine significantly longer injection life, low bleed and low injection port adhesion. The result is a general use green septum made of uniquely formulated silicone rubber you can use for all your daily analyses. Packaged in a pre-cleaned glass screw top jar for high purity.

Orange — Septa rated to 400 °C. Uniquely formulated silicone rubber septa BTO® is bleed and temperature optimized for today's most demanding GC and GC/MS applications. Septa BTO® is formulated to extend low-bleed and outstanding mechanical properties of premium GC septa. It retains remarkable softness at high temperatures and has been optimized to reduce injection port adhesion. Packaged in a pre-cleaned glass screw top jar for high purity.

Add-On Kits

Auto-Ignite FID with PPC Add-On Kit

Kit includes: detector assembly with heater and sensor, heater block, igniter, programmable pneumatics, and controls for detector combustion gases. Requires, but does not include, amplifier (N6120162) and AutoSystem XL firmware revision 3.3 or higher. The AutoSystem XL must be PPC ready. If not, a PPC upgrade kit (N6120146) is required.

Note: AutoSystem XL GCs shipped prior to January 1997 require a new detector cover. Installation by PerkinElmer Service is required, but not included.

Voltage	Part No.
120 V	N6120167
240 V	N6120168

Auto-Ignite FID Add-On Kit (Manual Pneumatics)

Kit includes: detector assembly with heater and sensor, heater block, igniter, hydrogen pressure regulator, and needle valve. Requires, but does not include, amplifier (N6120162). Requires AutoSystem XL to have firmware revision 3.3 or higher.

Note: AutoSystem XL GCs shipped prior to January 1997 require a new detector cover (N6103151).

Voltage	Part No.
120 V AutoSystem	N6120165
240 V AutoSystem	N6120166
120 V Clarus	N6520018
230 V Clarus	N6520019

FID Amplifier

Required for use with FID Detector Add-On Kit.

Dimension	Part No.
FID Amplifier	N6120162

Auto-Ignite FID Replacement Parts

Description	Part No.
1 Collector Head Assembly	N6100357
Silicone Rubber O-Ring* (not shown)	09902143
2 Polarizer Nozzle	N6103167
3 Nozzle Insulator	09907827
4 Nozzle Collector	N6101085
5 Body Assembly	N6103175
6 FID Jet Contact/Spring	N6001204
7 Jet Assembly	N6100361
8 FID Body	N6100364
9 Nozzle Assembly	N6100430

Detector Series Operation Kit

TCD/FID Series Operation Kit

Used to direct sample effluent from the TCD to the FID.

Dimension	Part No.
TCD/FID Series Operation Kit	N6120006

PID/FID Series Operation Kit

Used to direct sample effluent from the PID to the FID.

Dimension	Part No.
PID/FID Series Operation Kit	N6120059

FID Miscellaneous Accessories

Description	Part No.
Auto-Ignite Nozzle Replacement Tool For removing nozzle from auto-ignite FID body	N6103188
Auto-Ignite FID Catalytic Reactor Accessory	N6120161
Capillary Column Adapter For capillary column use with the FID 1/8 to 1/16 in. detector adapter	N6120020
Ceramic Column Cutter	N9301376
Cotton Applicators	N9301272
Detector Cover (Brown Color)	N6103225
Detector Cover (White Color)	N6103151
Eraser Brush-Pencil	09923078
Jet Assembly	N6100194
Jet Replacement Tool 1/4 in. nut driver for removing jet from auto-ignite FID body	N6101297
Quartz Wool	N6102354
Replacement Stainless Steel Glow Plug for Auto-ignite FID	N6103089
Septa, low bleed (pkg. 50)	N9302972
1/4 in. Packed Column Adapter For use with 1/4 in. packed columns. 1/8 to 1/4 in. adapter fits both injector and detector ends	00080100

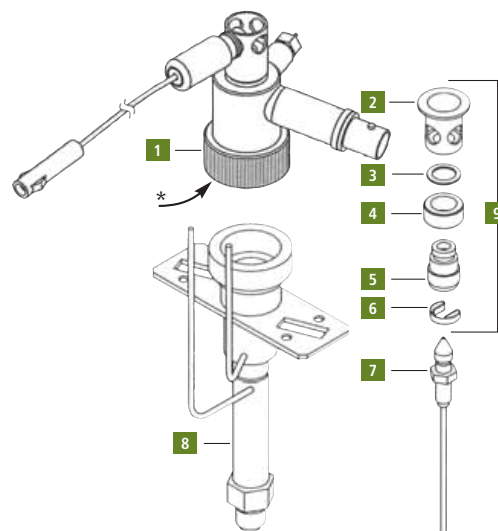

Catalytic Reactor Accessory

Auto-Ignite FID with PPC Add-On Kit

The catalytic reactor converts CO and CO₂ to methane conveniently and efficiently. The lower detection limit is extended to well below 0.1 ppm.

The catalytic reactor consists of a special catalytic reactor base which replaces the FID base. The reactor body contains a quantity of catalyst held in place by a quartz wool plug.

Kits include base assembly, reactor tube, and instructions.

External Igniter FID Catalytic Reactor Accessory

Description	Part No.
External Igniter FID Catalytic Reactor Accessory	N6120070

Auto-Ignite FID Catalytic Reactor Accessory

Description	Part No.
Auto-Ignite FID Catalytic Reactor Accessory	N6120161

Catalytic Reactor Replacement Parts

Description	Part No.
Catalyst	N9302698
Jet Assembly	N6100194
Quartz Wool*	N6102354

* Product available in the USA only

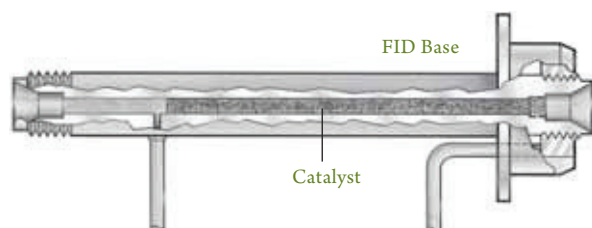

Miscellaneous Accessories

External Ignite Nozzle Replacement Tool

For removing nozzle from External Ignite FID body.

Description	Part No.
External Ignite Nozzle Replacement Tool	N6100102

Hydrogen Regulator Replacement Kit

Description	Part No.
Hydrogen Regulator Replacement Kit	N6100289

Hydrogen/Air Replacement Needle Valve

Description	Part No.
Hydrogen/Air Replacement Needle Valve	N6101412

Igniter Assembly

Complete replacement igniter assembly with glow plug.

Description	Part No.
Igniter Assembly	N6100016

Replacement Glow Plug for External Ignite FID

Description	Part No.
Replacement Glow Plug for External Ignite FID	00091279

FID Flow Measurement Adapter

Description	Part No.
FID Flow Measurement Adapter	N6101345

DETECTORS - FLAME PHOTOMETRIC DETECTOR (FPD)

Add-On Kits

The FPD is a highly sensitive and selective detector for both sulfur and phosphorus compounds. It is especially suitable for environmental monitoring of H₂S and sulfur gases in general and for organophosphorus compounds present at trace levels in pesticide analysis. Alkyl tin compounds can also be analyzed by changing the filter assembly. The sulfur filter is shipped standard.

The FPD mounts in either the front or rear detector position. This allows many detector combinations, such as FPD/FPD, FPD/TCD, and FPD/ELCD.

The AutoSystem also includes a linearizer function for the sulfur mode and convenient control of the photomultiplier tube from the keyboard.

The FPD is capillary-column compatible. The detector will accept columns of 0.530 mm i.d. or less. The standard jet shipped with the FPD does not have a glass-lined tail pipe. If an all-glass system is required and glass packed columns will be used, then a glass-lined tail pipe should be ordered (N6100264). As a reminder, use of packed 1/4 in. columns requires a 1/8 to 1/4 in. adapter.

Filters

Description	Part No.
Phosphorus Lens (Yellow)	N6000981
Sulfur Lens* (Blue)	N6000637
Tin Lens (Orange)	L4135472

* Shipped standard.

FPD Add-On Kit (Manual Pneumatics)

Kit includes detector, heater, sensor, heater block, hydrogen needle valve, air pressure regulator, and sulfur photomultiplier filter. Requires but does not include FPD amplifier (N6120095). Firmware revision 1.6 or greater required. Firmware must be PerkinElmer Service installed. AutoSystem operator's manual (09938559) revision E or higher required.

Voltage	Part No.
120 V AutoSystem	N6120088
240 V AutoSystem	N6120089
120 V Clarus	N6520028
230 V Clarus	N6520029

FPD Amplifier

Firmware revision 1.6 or greater required. Firmware must be PerkinElmer Service installed. AutoSystem operator's manual (09938559) revision E or higher required.

Description	Part No.
FPD Amplifier	N6120095

FPD Replacement Parts for AutoSystem Series GCs

Description	Part No.
1 O-Ring	09902247
2 Seal Assembly and Window (heat shield)	N9300096
3 Liner (window)	N6003057
4 FPD Body (upper)	N6100243
5 Window Holder	N6003066
6 FPD Jet, Glass-lined Jet Tailpipe (for all-glass system)	N6100245 N6100264
7 FPD Body (lower)	N6100244
8 Photomultiplier Tube	09972321

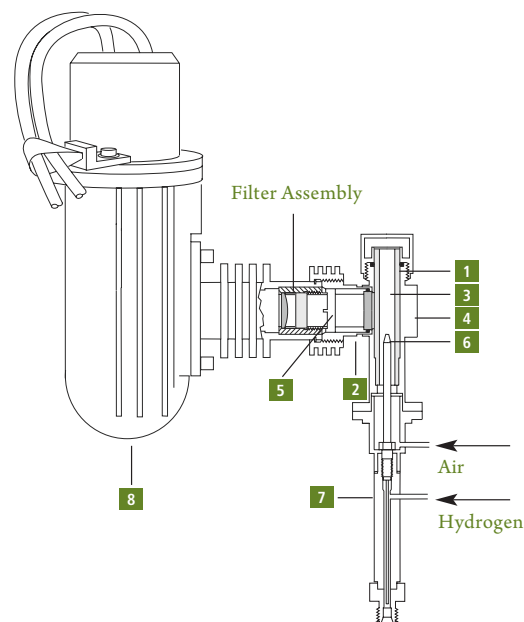

FPD with PPC Add-On Kit

Kit includes: detector, heater, sensor, heater block, programmable pneumatic control for detector combustion gases, and sulfur photomultiplier filter. Requires, but does not include, FPD amplifier (N6120095). AutoSystem XL GC must be PPC ready. If not, a PPC upgrade kit (N6120146) is required. Installation by PerkinElmer Service is required, but not included.

Voltage	Part No.
120 V	N6120128
230 V	N6120129

Packed Column Adapter

1/8 to 1/4 in. adapter for use with 1/4 in. packed columns.

Description	Part No.
Adapter (set of 2)	00080100

Add-On Kit

The ECD is a versatile, nondestructive detector which responds strongly to halogen-containing compounds as well as to certain other electron-capturing substances. The ECD's high sensitivity and selectivity make it an ideal choice for pesticide-residue analysis and for detection of halogen-derivatized compounds.

The ECD has an independent temperature range of 100 - 450 °C. The detector contains thermal protection that prevents heating the Ni63 source to temperatures beyond safe operating limits. Two ECDs can be installed and operated simultaneously on the AutoSystem Series and Clarus GCs. Nitrogen or argon/methane is the required detector operating gas. The base of the detector terminates in a 1/8 in. fitting.

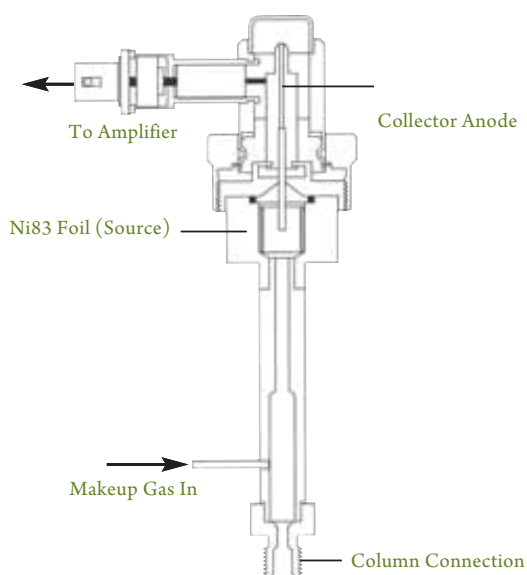

ECD Add-On Kit (Manual Pneumatics)

Kit includes all parts necessary to install an ECD on the AutoSystem Series or Clarus GCs. Includes: detector, heater, sensor, heater block, 1/16 in. makeup gas line, makeup gas needle valve, and vent tube assembly. Requires, but does not include, ECD amplifier (N6120014). Installation by PerkinElmer Service is recommended.

Voltage	Part No.
120 V AutoSystem	N6120011
240 V AutoSystem	N6120026
120 V Clarus	N6520020
230 V Clarus	N6520021

ECD Amplifier

Required for use with ECD detector with add-on kit.

Description	Part No.
ECD Amplifier	N6120014

ECD Add-On Kit (PPC Pneumatics)

Kit includes: detector, heater, sensor, heater block, and programmable pneumatic control for makeup gas. Requires, but does not include, ECD amplifier (N6120014). The AutoSystem XL or Clarus GCs must be PPC ready. If not, a PPC upgrade kit (N6120146) is required. Installation by PerkinElmer Service is required, but not included.

Voltage	Part No.
120 V	N6120122
230 V	N6120123

Vent Tube Assembly

Flexible tube to safely vent toxic sample effluent.

Description	Part No.
Vent Tube Assembly	N6100161

Column Adapters

Capillary Column Adapter/Receiver

Adapter converts 1/8 in. fitting to 1/16 in. for use with capillary columns.

Note: Glass-lined tubing reduces background from polyimide coating in high-temperature applications.

Description	Part No.
Capillary Column Adapter/Receiver	N6000986

PID/ECD Series Operation Kit

Kit for directing effluent from PID to ECD.

Description	Part No.
PID/ECD Series Operation Kit	N6120059

1/4 in. Packed Column Adapter

For use with 1/4 in. packed columns. 1/8 to 1/4 in. adapters fit both injector and detector ends. (Pkg. 2)

Description	Part No.
1/4 in. Packed Column Adapter	00080100

ECD Wipe Test Kit

U.S. Federal law requires that all ECDs be wipe-tested periodically as described in the instrument operator's manual. In the U.S., possession and use of ECD is regulated by N.R.C. and/or state regulatory agencies. Licensing by regulatory agencies is required. Outside of the U.S., check with governing bodies for licensing and regulations covering possession and use. This kit contains everything necessary to do a complete wipe test. For use on any model GC ECD.

Description	Part No.
PID/ECD Series Operation Kit	00091667

DETECTORS - NITROGEN PHOSPHOROUS DETECTOR (NPD)

Add-On Kit

NPD Add-On Kit (Manual Pneumatics)

The NPD can be used for the analysis of organic compounds containing nitrogen or phosphorus down to the picogram level. The NPD has become the detector of choice for low-level drug and pesticide applications because of its sensitivity and selectivity.

Kit includes: detector, heater, sensor, heater block, air needle valve, and hydrogen pressure regulator with snubber and two beads. Requires, but does not include, amplifier. For AutoSystem GC Firmware revision 1.4 or greater is required. Firmware must be PerkinElmer Service installed.

Voltage	Part No.
120 V AutoSystem	N6120090
240 V AutoSystem	N6120091
120 V Clarus	N6520024
230 V Clarus	N6520025

NPD Amplifier

Required for use with NPD Add-On Kit.

Description	Part No.
NPD Amplifier	N6120094

NPD with PPC Add-On Kit

Kit includes: detector, heater, sensor, heater block, and programmable pneumatic control for detector combustion gases and two beads. Requires, but does not include, amplifier (N6120094). The AutoSystem XL or Clarus GC must be PPC ready. If not, the PPC upgrade kit (N6120146) is required. Installation by PerkinElmer Service is required, but not included.

Voltage	Part No.
120 V	N6120126
240 V	N6120127

Column Adapter

1/4 in. Packed Column Adapter

1/8 to 1/4 in. detector receiver adapter for use with 1/4 in. packed columns. Two included (injector/detector).

Description	Part No.
1/4 in. Packed Column Adapter	00080100

Replacement Parts

	Description	Part No.
1	Collector Head	N6100253
2	Bead Assembly (pkg. 5) Single pkg.	N6120093 N6120092
3	Jet Assembly	N6100038
4	NPD Body	N6100228

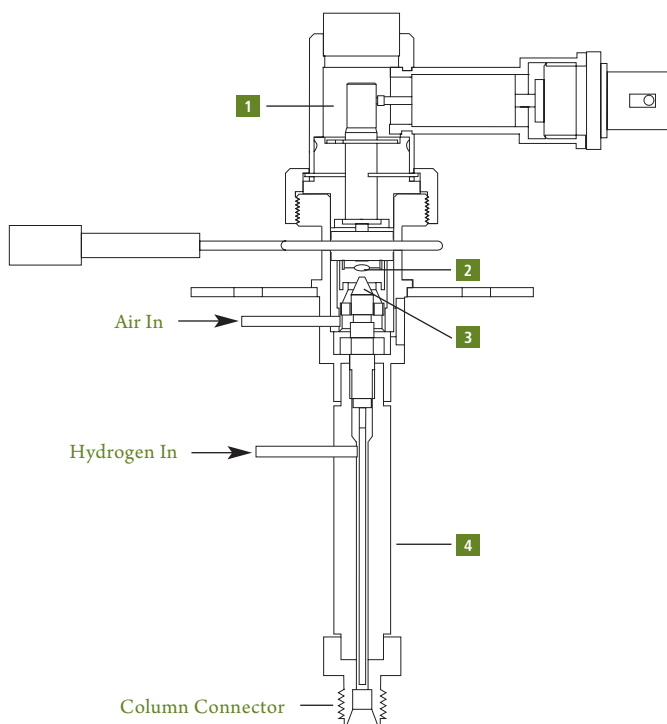

Add-On Kit

PID Add-On Kit (Manual Pneumatics)

The PID utilizes a high-intensity ultraviolet light source to ionize the sample components eluting from the column in order to generate the chromatographic signal. The PID has a maximum recommended operating temperature of 250 °C. The lamp can be replaced with a blanking disk to allow bake-out operation (up to 350 °C). Kit includes: detector, heater, sensor, makeup gas needle valve, and all necessary mounting hardware for installation on an AutoSystem GC. Requires, but does not include, amplifier (N6120061) and lamp power supply (N6120062). Firmware revision 1.2 or greater is required. Firmware must be PerkinElmer Service installed. AutoSystem operator's manual (09908559) is required if not revision F or higher.

Voltage	Part No.
120 V AutoSystem	N6120047
240 V AutoSystem	N6120057
120 V Clarus	N6520026
230 V Clarus	N6520027

PID Amplifier

Required for use with PID Add-On Kit.

Description	Part No.
PID Amplifier	N6120061

PID Lamp Power Supply

Required for use with PID Add-On Kit.

Description	Part No.
PID Lamp Power Supply	N6120062

PID with PPC Add-On Kit

Kit includes: detector, heater, sensor, heater block, and programmable pneumatic control for makeup gas. Requires, but does not include, amplifier (N6120061) and power supply (N6120062). The GC must be PPC ready. If not, a PPC upgrade kit (N6120146) is required. Installation by PerkinElmer Service is required, but not included.

Voltage	Part No.
120 V	N6120130
230 V	N6120131

Detector Series Operation Kits

Description	Part No.
PID/FID, PID/ECD Series kit for directing effluent from a PID to an FID or an ECD	N6120059

Miscellaneous Accessories

Description	Part No.
Bakeout Disk	03302989
Lamp Cleaning Compound	03302775
1/4 in. Detector Receiver	03300866
1/8 in. Detector Receiver	03300865

Replacement Parts

Description	Part No.
1 PID Lamp (10.2eV), For most applications including aromatics, alkenes, and aliphatics higher than C4. Shipped standard with PID PID Lamp (9.5eV), Improved selectivity for multiple ring aromatic, sulfur compounds	03303599 03303598
2 PID Lamp Window Seal	03302778
3 PID Lower Lamp Seal	03302777
4 Shoulder Pin	03302976
5 Cap Nut	03303773
6 Base Assembly	03302979
7 Spring	03302973
8 Cap with Harness	N6101696

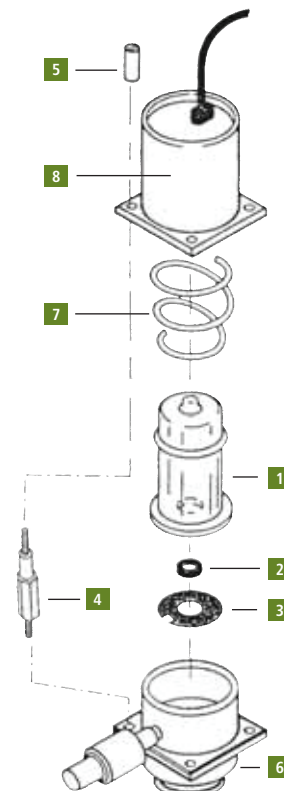

Add-On Kits

Features and Benefits:

- Lower Internal Volume and Smaller Overall Size
- No Makeup Gas Required with 0.53 mm and 0.32 mm i.d. Capillary Columns
- Series Connection Option
- Excellent Sensitivity Over a Wide Dynamic Range

TCD Add-On Kit (Manual Pneumatics)

Kit includes all necessary items to install the TCD into the instrument: detector, heater, sensor, heater block, 1/16 in. gas line, and flow controller pneumatics. Requires, but does not include, amplifier (N6120015). The TCD can only be installed in the rear detector position.

Voltage	Part No.
120 V AutoSystem	N6120012
240 V AutoSystem	N6120027
120 V Clarus	N6520022
230 V Clarus	N6520023

TCD Amplifier

Description	Part No.
TCD Amplifier	N6120015

TCD with PPC Add-On Kit

Kit includes: detector, heater, sensor, heater block, and programmable pneumatic control for reference gas. Requires, but does not include, amplifier (N6120015). The TCD can only be installed in the rear detector position. The GC must be PPC ready. If not, a PPC upgrade kit (N6120146) is required. Installation by PerkinElmer Service is required, but not included.

Voltage	Part No.
120 V	N6120124
240 V	N6120125

TCD with PPC Makeup Gas Kit

Includes parts required to add PPC controlled makeup gas to an existing TCD. Includes tubing, tee-piece, PPC pneumatics module, and PPC frit #4 (N6120155). Requires PPC capability in the GC.

Description	Part No.
TCD with PPC Makeup Gas Kit	N6120150

Column Adapter

Description	Part No.
1/8 to 1/4 in. Column adapter for use with 1/4 in. packed columns	00080100
1/8 to 1/16 in. Column adapter for use with capillary columns	N6120020

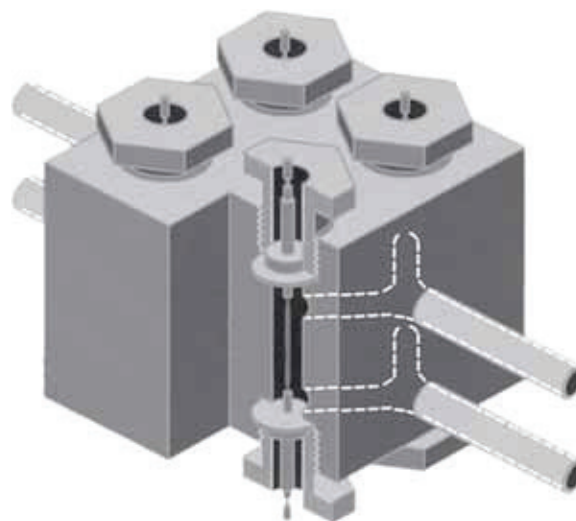

Thermal Conductivity Detector

TCD/FID Series Operation Kit

TCD and FID series operation kit for directing effluent from a TCD to an FID.

Description	Part No.
TCD/FID Series Operation Kit	N6120006

TCD Detector Makeup Gas Kit (Manual Pneumatics)

For use with TCD (at low flow rates). Required when using 0.25 mm i.d. and recommended when using 0.32 mm i.d. capillary columns. Kit includes 1 m of 1/16 in. tubing to connect to gas supply, graphite/vespel ferrules, manual pneumatics, and installation instructions.

Description	Part No.
TCD Detector Makeup Gas Kit (Manual Pneumatics)	N6120080



The Marathon™ Filament is a revolutionary, patent-pending technology developed exclusively by PerkinElmer, delivering long life even under the most difficult chromatography conditions.

After lengthy performance testing and filament research, the new Marathon Filament has been engineered to provide exceptional long life and withstand difficult chromatography conditions.

It has high resistance to demanding injections such as Headspace or purge and trap and has stood up to challenging applications such as flame-retardant analysis.

The Marathon Filament is a direct replacement of the previous rhenium filament — no system changes required.

At PerkinElmer, we understand your challenges and are committed to providing the best solutions to make your life easier. The new Marathon Filament is part of our ongoing efforts to deliver the latest technology for our PerkinElmer GC/MS platform.

Features and Benefits

- Long life even under the most difficult chromatography conditions
- Unique white surface engineered for maximum durability and optimum performance
- Now included with all new Clarus® GC/MS systems (S80 and SQ8 series)
- Backward compatible with all units using rhenium filaments
- Works with both electron and chemical ionization sources

Description	Part No.
Marathon Filament for PerkinElmer GC/MS Systems	N6470012

To view the webcast and to order your replacement filament, visit:
www.perkinelmer.com/MarathonFilament

SIMPLE FLEXIBLE PRODUCTIVE

SMARTsource™ with Marathon Filament for Clarus® SQ 8 GC/MS Systems

Capable of both EI and CI ionization, the SMARTsource (Simplified Maintenance And Removal Technology) on the Clarus SQ 8 GC/MS has been designed for ultimate simplicity, flexibility and productivity. Switching sources can be done in a matter of seconds by simply twisting and pulling – no tools required, no wires to disconnect. Cleaning the source is equally as easy and can be performed by the user. So even if you're running tough matrices, you won't be slowed down by time-consuming expensive source cleanings and replacements.

Fewer Parts, Greater Ease.

With very few parts, the SMARTsource is exceptionally robust and easy to maintain. Each component is clearly marked for simple reassembly, and reconfiguring between EI and CI can even be performed in less than 3 minutes with a quick-conversion kit. Since the source is removed from the front of the Clarus SQ 8, the analyzing quadrupole is never exposed, minimizing the risk of contamination to ensure more reliable data.

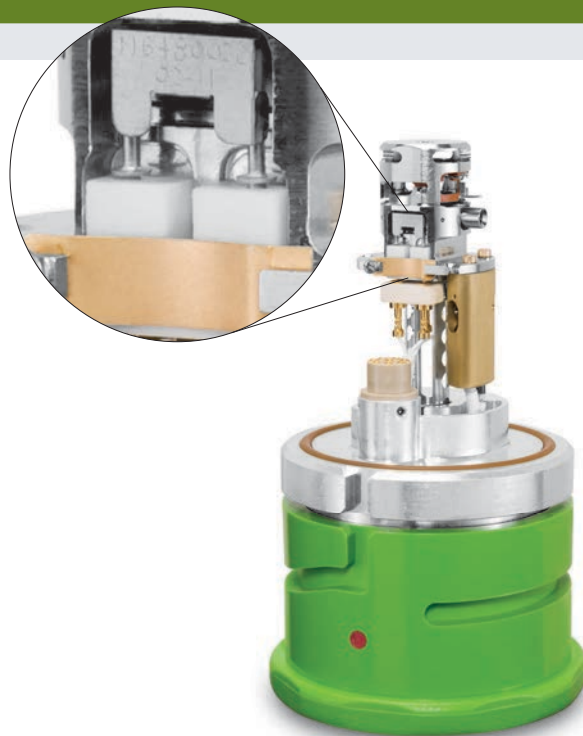

Features and Benefits:

- 12 parts make up EI source
- SMARTsource rebuilt in minutes
- Remove SMARTsource with the twist of a wrist
- Marathon filament has a long life even under the most difficult chromatography conditions and is engineered for maximum durability and optimum performance



Take the guesswork out of setting your column depth. Our Handle Assembly allows for precise alignment of the column within the SMARTsource every time.

Handle Assembly (Source Blank and Sight)

Description	Part No.
Handle Assembly (Source Blank and Sight)	N6480380
Replacement Protective Cover	N6482024

SMARTsource Maintenance Kits

Description	Part No.
SQ8 Maintenance Kit Tool kit needed to maintain source	N6480360
SQ8 Deluxe Polishing Kit (120 Volt) Kit for polishing cleanable source parts	N6480361
SQ8 Deluxe Polishing Kit (240 Volt)	N6480362

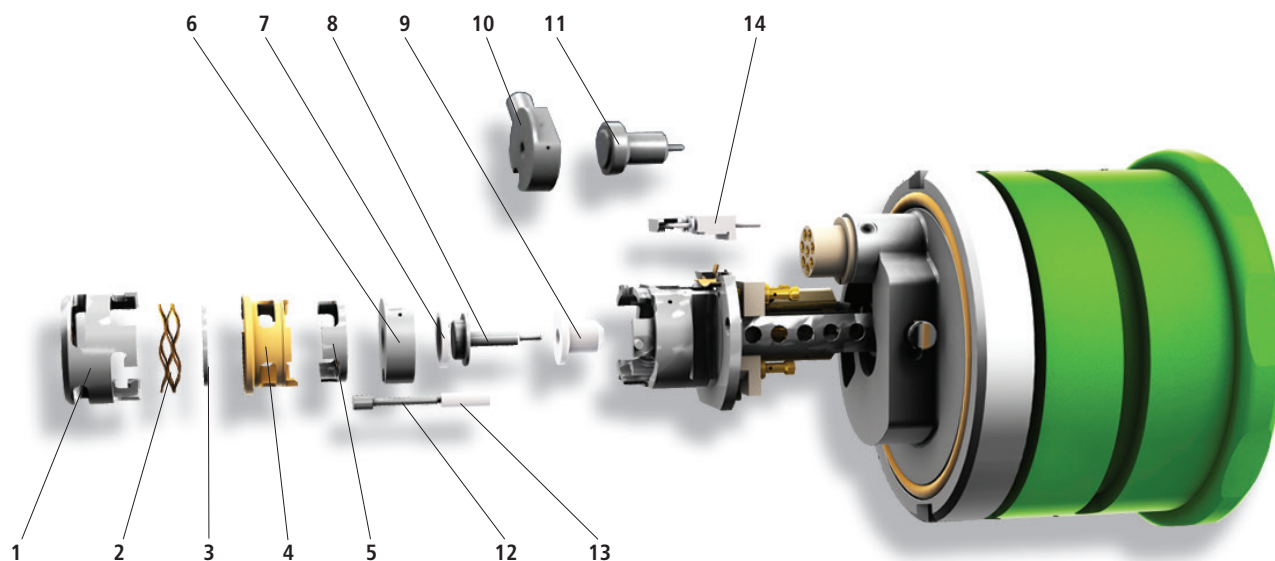

SMARTsource Replacement Parts

Number	Description	Part No.
1	Source Lens #3	N6480149
2	Source Spring	N6480151
3	Source Lens #2	N6480148
4	Lens Insulator	N6480153
5	Source Lens #1	N6480147
6	EI Ion Volume	N6480144
7	Insulator (Ion Volume)	N6480145

Number	Description	Part No.
8	Repeller	N6480140
9	Insulator (Repeller)	N6480141
10	CI Ion Volume	N6480146
11	CI Ion Volume Disc	N6480154
12	Trap	N6480142
13	Insulator (Trap)	N6480143
14	Marathon Filament	N6470012

SMARTsource Kits

Description	Part No.
Complete CI Source Consists of a fully assembled CI Source, ready to install	N6480130
Complete EI Source Consists of a fully assembled EI Source, ready to install	N6480132
Insulator Replacement Kit (Numbers 2, 4, 7, 9, 13)	N6480080
EI Optics Replacement Kit (Numbers 1, 3, 5, 6, 8, 12)	N6480081
CI Optics Replacement Kit (Numbers 1, 3, 5, 8, 10, 12)	N6480082

PACKED TRAPS SPECIFICALLY DESIGNED FOR PERKINELMER THERMAL DESORBERS

Air Monitoring Trap

Low flow trap packed with carbonaceous sorbents suitable for ozone precursor and air toxin monitoring.

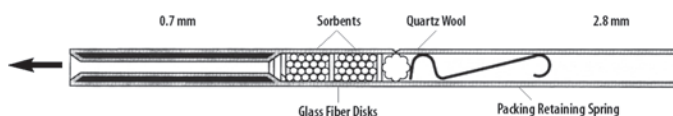

Low Flow Cold Trap

Cold Traps

TurboMatrix Thermal Desorption Trap Supplies

Trap supplies from PerkinElmer, the market leader in thermal desorption, will provide exceptional analytical performance. Used for U.S. EPA Method TO17, the PerkinElmer standard trap, packed with Tenax™, on the TurboMatrix™ Thermal Desorber, will improve productivity and trapping capacity. The TurboMatrix air monitoring trap is packed with carbonaceous sorbents suitable for ozone precursor and air toxics monitoring.

Description	Qty.	Part No.
Cold Traps for TurboMatrix		
Air Monitoring Trap	1	M0413628
Empty Trap	1	M0413627
Tenax™ TA 60/80 Packed Trap	1	M0413535
Carbopack® C Packed Trap	1	N6200150
Cold Traps for ATD 400		
Air Monitoring Trap	1	L4275108
Trap Nuts (2 required)	1	L4275009
Trap Tube Low Flow, Empty (Narrow-bore at one end. Allows minimum gas flow during trap desorption)	1	L4275107
Tenax™ TA 60/80 Packed Trap	1	L4275089
Empty Trap	1	L4271106



Cold Traps Fittings and Accessories

Description	Qty.	Part No.
Graphite Ferrule	2	L4271187
SilTite™ Ferrule (GC/MS) 0.4 mm	10	N9306093
SilTite™ Ferrule (GC/MS) 0.5 mm	10	N9306094
SilTite™ Ferrule (GC/MS) 0.8 mm	10	N9306095
SilTite™ Nuts	5	N9306096
PTFE Ferrule	10	L4275110
Graphite/Vespel® Ferrule for ATD 400	5	L1003027
Valco® Graphite/Vespel® Ferrule for ATD 400	5	L1003028
Trap Filter Disk		L1003030
Trap Packing Disk	20	L4271290
Trap Packing Retaining Spring	5	N6301054
Quartz Wool (Untreated) 5 g		N6102354
Cold Trap Packing Tool		L4271203
Cold Trap Removal Tool		L4271205
Regulator 0–60 psig		N6101474
Backflush Nozzle for ATD 400		L4275072
Internal Standard Injection Accessory for ATD 400		L4270010
Liquid Nitrogen Accessory for ATD 400		L4270009
Gauze Loading Rig		L4070023
Replacement Plastic Plunger for Gauze Loading Rig		L4071151



Thermal Desorber Starter Kit

PerkinElmer's convenient starter kit includes all products you need to run the TurboMatrix Thermal Desorber.

Features and Benefits

- All items available under one part number in a convenient kit
- Guaranteed PerkinElmer parts
- Improved chromatography with exceptional analytical performance using PerkinElmer parts

Description	Part No.		
Thermal Desorber Starter Kit	M0413541		
Contents	Pkg.	Qty.	Part No.
Glass Fiber Separator Disks	20	1	L4271290
Glass Sample Tubes	10	1	M0413598
Glass Wool	1	1	54120790
Graphite Ferrules	2	1	L4271187
O-ring	1	1	L1003006
O-ring, Viton	1	1	L1003008
Packing Gauze	100	1	L4071034
PTFE Filter Discs	10	1	L1003030
PTFE Filter Discs - Large	10	1	L1003029
Retaining Spring	50	1	L4071123
Sample Tube - 5 mL	1	1	04970673
Stainless Steel Retaining Spring	2	1	L6301054
Stainless Steel Sample Tubes - Capped	10	1	M0413595
Tenax TA 60/80, Mesh - 15 g	1	1	04978064
Trap Tube Nuts	2	1	L4275009
Trap Tubes	2	1	M0410094

Thermal Desorber Industrial Hygiene Application Kit

All your consumable needs in one convenient kit, designed specifically for Industrial Hygiene using Thermal Desorption*.

Description	Part No.		
Workplace Air Monitoring Industrial Hygiene Application Kit**	N6710188		
Contents	Pkg.	Qty.	Part No.
Cold Trap O-ring, 0.145 i.d./0.070 w.d.	1	1	09200091
Cold Trap Tube (Tenax TA)	1	1	L4275089
Empty Glass Sample Tubes - No Caps	10	1	L4071594
Graphite Ferrule	2	1	L4271187
Pen Clips for Stainless Steel Sample Tubes	10	1	L4071029
PTFE Ferrule	10	1	L4275110
PTFE Filter Disk - Either Side of the Cold Trap	10	1	L1003030
Tenax TA Stainless Steel Sample Tubes	10	1	N9307005

* For full downloadable pdf format application notes, please visit: <http://las.perkinelmer.com/applications>

** Applicable to TurboMatrix 100/150/300/350 and 650 only

Thermal Desorber Caps and Accessories

Description	Pkg.	Part No.
Brass Long-Term Storage Caps Recommended for long-term storage, two required per tube. Also requires PTFE Ferrule (L1003015).	1	09908851
Combined PTFE Ferrule For use with ¼ in Brass Long-Term Storage Caps (09908851), two required per tube.	5	L1003015
Diffusion Caps - Standard For passive air sampling, to ensure correct diffusion path length.	10	L4070207
Diffusion Caps with Membrane As above, 10 with silicone membrane inserted	10	L4070208
Pen Clips For Stainless Steel Thermal Desorber Tubes.	10	L4071029
PFA PTFE Ferrules For TurboMatrix Storage End Caps.	20	M0413625
TurboMatrix Analytical Caps PTFE Caps with O-ring, Required for Use on the TurboMatrix Instrument During Analysis	20	N6200119

CONDITION TUBES FASTER AND EASIER

PerkinElmer's New ATD tube conditioning oven now conditions tubes faster and easier than ever before. ATD tubes must be re-conditioned after analysis to remove contaminants before they are used for sampling. You can do this one of two ways. You can condition each tube individually on your thermal desorption instrument. This takes time – especially if you have several tubes to condition – and also ties up your instrument which could be used for more important analysis. Or, a better more efficient alternative is to condition your tubes in a separate oven.

PerkinElmer ATD Tube Conditioning Oven:

- Condition any number or combination of stainless steel and glass tubes simultaneously without wasting gas
- Hood interlock protects anyone in the lab from opening the oven until it's cool
- Dual automatic fan design cools the oven in minutes
- Oven vent through the top hood ensuring a contaminant free oven

Description	Part No.
TurboMatrix TC 220 (120V)	N9309160
TurboMatrix TC 220 (230V)	N9309161



Specifications

Description	
Capacity	Holds up to 20 tubes
Temperature Range	Ambient – 400 °C
Programming	4 Ramps + 4 Soaks
Flow Rate	25 – 150 mL/min



Unconditioned Thermal Desorber Tubes



Fully conditioned Thermal Desorber tubes shown



SVI™ Soil Vapor Intrusion™ Tubes

Soil vapor intrusion occurs when toxic compounds that are present in the air space in soil of a contaminated location have ways of entering a building, potentially creating a health risk. Our new multi-bed construction extends the hydrocarbon range past naphthalene while retaining the lighter components, enabling larger sample volumes, hence, enhancing detection limits. Has a unique design that meets the challenges and criteria of the EPA regulations for air monitoring.

- From chloromethane through diesel range hydrocarbons
- After the analysis, tubes are clean and ready for re-sampling reducing costs

Empty Sample Tubes with Plastic End Caps

Description	Part No.
Stainless Steel (pkg. 10)	M0413595
Glass Lined Stainless Steel (pkg. 10)	M0413597
Glass (pkg. 10)	M0413598

Unconditioned Thermal Desorber Tubes

For your convenience, new low-cost thermal desorber tubes are offered in both stainless steel and glass. Each tube maintains its unique serial number which is etched for easy identification. Tubes are offered with a variety of sorbent packing materials for many GC applications including indoor and outdoor air monitoring, analysis of flavors and fragrances and the analysis of outgassing from packaging, polymers, pharmaceuticals and semi-conductor material. These tubes are unconditioned and ship with plastic end caps for short-term storage.

Packed Unconditioned Sample Tubes, Plastic End Caps (pkg. 10)

Sorbent	Stainless Steel Part No.	Glass Part No.
Air Toxics	N9307050	N9307058
Carbopack™ B60/80	N9307051	N9307059
Carbosieve™ SIII 60/80	N9307052	N9307060
Tenax™ GR 60/80	N9307053	N9307061
Tenax™ TA 60/80	N9307054	N9307062
Chromasorb™ 60/80	N9307055	N9307063
Carbopack™ B 60/80	N9307056	N9307064
Carbopack™ C 60/80		
Carbosieve™ SIII 60/80		
Carbotrap™ C/B		N9307065
NIOSH	N9307057	N9307066

Empty Sample Tubes without Caps

Description	Part No.
Stainless Steel (pkg. 10)	L4270128
Glass (pkg. 10)	L4071594
Stainless Steel (pkg. 100)	L4270129

Description	Part No.
Stainless Steel TD Tubes Conditioned	N9306277
Stainless Steel TD Tubes Un-Conditioned	N9306278

Conditioned Thermal Desorber Tubes

Stainless steel and glass sample tubes are available with a wide variety of packing materials from single to multi-bed. PerkinElmer Thermal Desorber tubes are printed with the packing material and an arrow, which points to the end of the tube where sample is drawn from, and also indicates the end that desorb vapors will exit.

Each tube is etched with a unique serial number for ease of traceability and adsorbent identification. Stainless steel tubes may also be fitted with clips that accept adhesive labels for identification. Packed tubes are shipped with long-term brass storage caps and all tubes are thermally conditioned and tested for background and backpressure.

Packed Conditioned Sample Tubes, Brass Long-Term Storage End Caps (pkg. 10)

"NOT for Analytical test applications", use N6200119 PTFE caps and O-rings. (pkg. 20)

Sorbent	Stainless Steel Part No.	Glass Part No.
Air Toxics	N9307001	N9307008
Carbopack™ B60/80	N9307002	N9307009
Carbosieve™ SIII 60/80	N9307003	N9307010
Tenax™ GR 60/80	N9307004	N9307011
NEW PKI Tenax™ TA 60/80	N9309130	
Tenax™ TA 60/80	N9307005	N9307012
Chromasorb™ 60/80	N9307006	N9307013
Carbopack™ B 60/80	N9307000	N9307007
Carbopack™ C 60/80		
Carbosieve™ SIII 60/80		
Carbotrap™ C/B	N9307026	
NIOSH 2549	N9307038	N9307037

TurboMatrix 40 Headspace Trap

Sample Head Assembly Replacement Parts

Description	Part No.
① Platinum/Iridium Needle, Wide-bore	B0144169
① Platinum/Iridium Needle, Small-bore	B0500959
① Platinum/Iridium Needle, Jet	B0510364
① Silcosteel Needle, for Headspace Trap Only	N6700130
① Stainless Steel Needle, Wide-bore	B0131385
① Stainless Steel Needle, Small-bore	B0500987
① Stainless Steel Needle, Jet (Ships with Instrument)	B4000011
② Needle Seal Assembly (Without O-Rings)	B0500833
③ O-Ring for Needle Seal Assembly (pkg. 10)	B0198110
④ Vespel Ferrule 1/16 in. (pkg. 10)	09920127
⑤ Male Nut 1/16 in.	N9302832
⑥ GLT Adapter Tube	B0503956
⑥ GLT Adapter Tube, Silcosteel	N6700113
⑦ Graphite/Vespel Ferrule 1/16 in. x 0.4 mm For use with 0.25 mm i.d. Transfer Line, pkg. 10	09920104
⑦ Graphite/Vespel Ferrule 1/16 in. x 0.5 mm For use with 0.32 mm i.d. Transfer Line, pkg. 10	09920105
⑧ Nut 1/16 in. Swagelok	N9300059
⑨ Fused-Silica Capillary Transfer Line: 0.25 mm i.d. x 5 m Length	N9301356
⑨ 0.32 mm i.d. x 5 m Length	N9301357

Headspace Sample Head Assembly Schematic

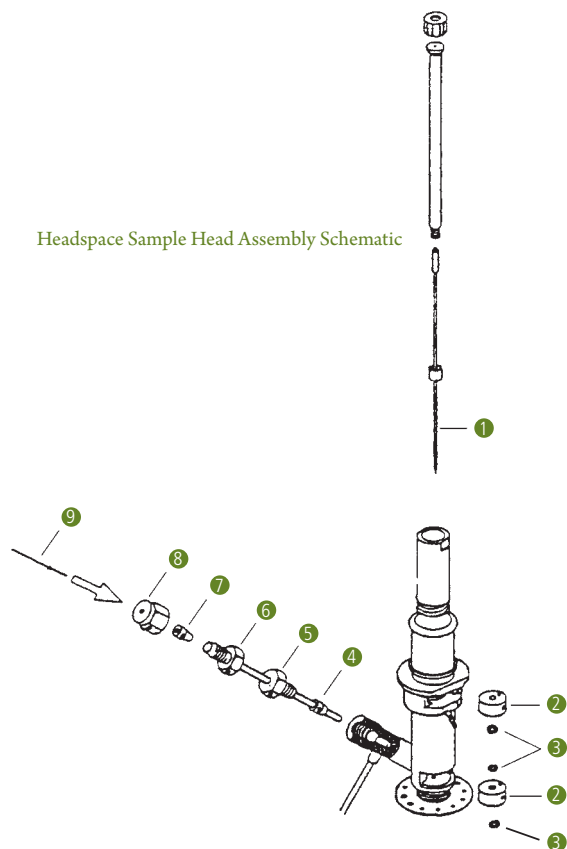

Solid Glass Blocking Trap

Description	Part No.
Block for Use in Standard Headspace Mode.	N6701170

Sample Trays

For use on the Mid-Range or High-Capacity headspace sampler.

Description	Part No.
TurboMatrix 40 Mid-Range Sample Tray	M0413592
TurboMatrix 110 High-Capacity Sample Tray	M0413593

Transfer Lines

Description	Tubing i.d.	Length	Part No.
Siltek Deactivated Fused Silica	0.25 mm	5 m	N9316607
Siltek Deactivated Fused Silica	0.32 mm	5 m	N9316608

Miscellaneous Accessories

Description	Part No.
Gas Chromatography — Theory and Practice, Static Headspace Book by L. Ettre and B. Kolb	N1011210

Cold Trap Options

Headspace Trap instruments only.

Description	Part No.
TurboMatrix HS Trap Cold Trap Tube (Carbopack C)	N6200150
TurboMatrix HS Trap Air Monitoring Trap*	M0413628

* Trap comes standard with the instrument.

HIGH QUALITY GAS FILTRATION SYSTEMS

Features and Benefits:

- Two indicators – for oxygen and moisture
- Gas contacts only metal, fluoroelastomer and glass
- High capacity and efficiency in a single cartridge
- Easy cartridge replacement with on/off knob
- Double-seal construction for safety
- Check valves protect gas lines during cartridge replacement
- Includes mounting hardware for bench or wall

The Advanced Filter System has high-capacity and efficiency levels for oxygen, water and hydrocarbons. The recommended maximum flow rate is 2 L/min with 200 psi maximum operating pressure.

A polycarbonate shield surrounding the glass indicator section of the filter is sealed, unlike other gas filters, the gas flow is secure even if the glass should break. This redundant sealing system and robust construction provides a new level of security in gas filtration.



Advanced Filter System

Description	Part No.
Advanced Filter System	N9303963
Replacement Cartridge for Oxygen, Water and Hydrocarbons	N9303964
Manifold and Mounting Hardware	N9303139

	Capacity	Efficiency
Oxygen	850 cc	<1 ppb
Water	12 g	<10 ppb
Hydrocarbons	8 g	<1 ppb

HIGH CAPACITY AND HIGH PURITY

Ultra Clean Gas Filters

Wrenches to change filters is a thing of the past. There is no longer a need for loosening and tightening fittings every time a trap is changed, which may contaminate your system during the process. Cartridge systems make changing gas filters quick and easy. A base plate allows cartridges to be exchanged without introducing ambient air. Spring-loaded check valves seal when a filter is removed and open only when a new filter has been locked in place.

Carrier Gas Purity

Carrier gas should contain less than 1ppm of oxygen, moisture, or other trace contaminants to prevent column degradation, increase column lifetime, and decrease stationary phase bleed. The expense of using high-purity gases in combination with carrier gas line purifiers will be offset by longer column lifetime and less GC maintenance.

Contaminants cause ghost peaks to appear during temperature programming and degrade the validity of analytical data. Make-up gas also should be contaminant-free, or baseline fluctuations and excessive detector noise can occur. Detector gases should be free of water and hydrocarbons, or excessive baseline noise can result. Gas purifiers remove these contaminants from gas sources, thereby improving system performance.

Base Plates

	1 Position	2 Position	3 Position
Description	Part No.	Part No.	Part No.
Ultra Clean Base Plate - Brass 1/8"	N9306801	N9306805	N9306811
Ultra Clean Base Plate - Brass 1/4"	N9306800	N9306804	N9306810
Ultra Clean Base Plate - Stainless Steel 1/8"	N9306803	N9306807	N9306813
Ultra Clean Base Plate - Stainless Steel 1/4"	N9306802	N9306806	N9306812

	2 Position Base Plate
Description	Part No.
Ultra Clean High Flow Base Plate - Brass 1/4"	N9306808
Ultra Clean High Flow Base Plate - Stainless Steel 1/4"	N9306809

Kits - Base Plate and Cartridges

	Triple Filter	Triple filter with He Conditioning	Triple filter with H2 Conditioning
Base Plate Description	Part No.	Part No.	Part No.
Ultra Clean Base Plate - Brass 1/8" (1 Position)	N9306829	N9306833	N9306837
Ultra Clean Base Plate - Brass 1/4" (1 Position)	N9306828	N9306832	N9306836
Ultra Clean Base Plate - Stainless Steel 1/8" (1 Position)	N9306831	N9306835	N9306839
Ultra Clean Base Plate - Stainless Steel 1/4" (1 Position)	N9306830	N9306834	N9306838

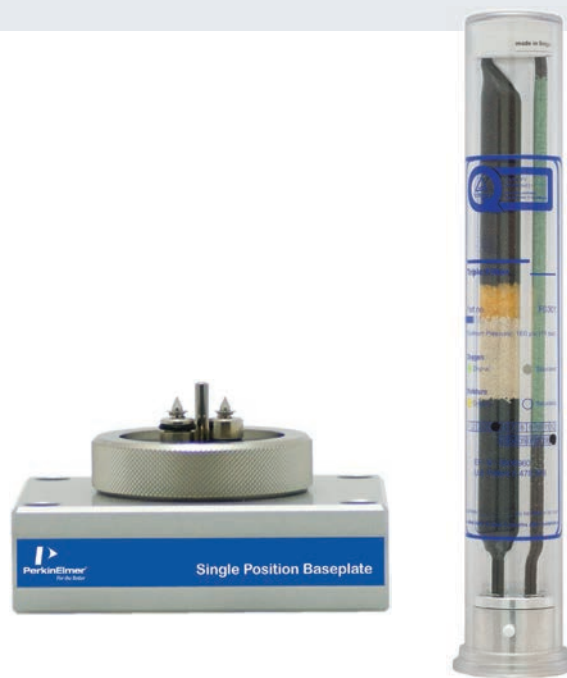

Features and Benefits:

- High purity output insures 99.9999% pure gas
- No tool replacement of filter cartridges, no need to shut gas flow off with quick disconnect base plate
- Easy to read indicators to determine replacement interval
- Helium and Hydrogen specific cartridges available: operational with 15 minute purge after installation
- Safety shielding of glass filter with plastic cover
- Serial numbered for ease of tracking

Kits - Base Plate and Cartridges (cont.)

Base Plate Description	Hydrocarbon Filter (2/pack) Part No.
Ultra Clean High Flow Base Plate - Brass 1/4" (2 Position)	N9306840
Ultra Clean High Flow Base Plate - Stainless Steel 1/4" (2 Position)	N9306841

Base Plate Description	Triple Filter (1/pack), Combi Filter (2/pack) Part No.
Ultra Clean Base Plate - Brass 1/8" (3 Position)	N9306843
Ultra Clean Base Plate - Brass 1/4" (3 Position)	N9306842
Ultra Clean Base Plate - Stainless Steel 1/8" (3 Position)	N9306845
Ultra Clean Base Plate - Stainless Steel 1/4" (3 Position)	N9306844

Cartridges - Replacements

Description	Part No.
Ultra Clean Moisture Filter	N9306814
Ultra Clean Oxygen Filter	N9306815
Ultra Clean Hydrocarbon Filter	N9306816
Ultra Clean Hydrocarbon Filter with AT indicator	N9306817
Ultra Clean Combi Filter (Moisture - Hydrocarbon)	N9306818
Ultra Clean Triple Filter (Oxygen - Moisture - Hydrocarbon)	N9306819
Ultra Clean Triple Filter (Oxygen - Moisture - Hydrocarbon) with AT indicator	N9306821
Ultra Clean Triple Filter (Oxygen - Moisture - Hydrocarbon) conditioned with He	N9306820
Ultra Clean Triple Filter (Oxygen - Moisture - Hydrocarbon) conditioned with H2	N9306822

Cartridges - Bundles

Description	Part No.
Ultra Clean High Flow Moisture Filter Bundle (2 High Flow Moisture Filters)	N9306824
Ultra Clean High Flow Hydrocarbon Filter Bundle (2 High Flow Hydrocarbon Filters)	N9306823
Ultra Clean High Flow Hydrocarbon Filter Bundle (2 High Flow Hydrocarbon Filters)	N9306825
Ultra Clean High Flow Hydrocarbon Filter Bundle (2 High Flow Hydrocarbon Filters) with AT indicators	N9306825
Ultra Clean Filter Bundle of 3 (1 Triple Filter, 2 Combi Filters)	N9306826
Ultra Clean Filter Bundle of 4 (1 Oxygen Filter, 1 Moisture Filter, 2 Hydrocarbon Filters)	N9306827

Connectors

Description	Pkg.	Part No.
Ultra Clean Connector Set - 1/4" Brass 3 Sets of two Connectors (in- and outlet) for Base plate	6	N9306846
Ultra Clean Connector Set - 1/8" Brass 3 Sets of two Connectors (in- and outlet) for Base plate	6	N9306847
Ultra Clean Connector Set - 1/4" SS 3 Sets of two Connectors (in- and outlet) for Base plate	6	N9306848
Ultra Clean Connector Set - 1/8" SS 3 Sets of two Connectors (in- and outlet) for Base plate	6	N9306849
Ultra Clean High Flow Connector Set - Brass 1/4" 3 Sets of two Connectors (in- and outlet) for Base plate	6	N9306850
Ultra Clean High Flow Connector Set - 1/4" SS 3 Sets of two Connectors (in- and outlet) for Base plate	6	N9306851

Flush Caps

Description	Pkg.	Part No.
Ultra Clean Flush Cap Replacement Set 2 Flush Caps for Base Plate	2	N9306852
Ultra Clean High Flow Flush Cap Replacement Set 2 Flush Caps for High Flow Base Plate	2	N9306853

O-Rings

Description	Pkg.	Part No.
Ultra Clean Base Plate O-ring Replacement Set Two sets of 10 O-rings for Base plate	20	N9306854

Wall Mounting

Description	Part No.
Ultra Clean Wall-mounting Bracket Set Suitable for genuine Ultra Clean Base plates	N9306855

Particle Filters

Description	Part No.
Ultra Clean 0.5 Micron Particle Filter (1/4" Brass)	N9306856
Ultra Clean 0.5 Micron Particle Cup Filter Pack Replacement Filter Element - pack of 12	N9306857

SAVE TIME AND MONEY

PerkinElmer Click-On inline Super Clean™ purifiers reduce your maintenance system downtime

Using the Click-On Connectors lets you change the trap without introducing contaminants into your system. Click-On connectors can replace a trap, without introducing impurities into the system. This in turn eliminates the need to flush the system.

The ability to add a Click-On Inline Super Clean™ Indicator after the stainless steel trap gives the user a clear visual indication of when to change the filter. This indicator may also be used as a standalone trap.

Features and Benefits

- Reduce system downtime with Click-On fast connectors
- No open gas line when changing the trap
- Helium Specific Glass Indicating Triple Trap is ideal for GC/MS

Stainless Steel Trap Kits

Description	Connector (Qty)	Part No.
Combination: Oxygen/Moisture Trap	1/8" Brass (2)	N9306108
Combination: Oxygen/Moisture Trap	1/8" SS (2)	N9306109
Combination: Moisture/Hydrocarbons Trap	1/8" Brass (2)	N9306117
Combination: Moisture/Hydrocarbons Trap	1/8" SS (2)	N9306118
Triple: Oxygen/Moisture/Hydrocarbons Trap	1/8" Brass (2)	N9306110
Triple: Oxygen/Moisture/Hydrocarbons Trap	1/8" SS (2)	N9306111
Triple Gas Specific (He): Oxygen/Moisture/Hydrocarbons	1/8" Brass (2)	N9306112
Triple Gas Specific (He): Oxygen/Moisture/Hydrocarbons	1/8" SS (2)	N9306113

Product Specifications

Purifier Type	Gas Quality*	Max. Pressure	Max. Flow	Use For	H ₂ O	Capacity O ₂	Hydrocarbons	Est. Lifetime
Moisture	99.9999%	11 bar, 160 psi	25 L/min	Inert carrier gas He, Air, H ₂	21 g	NA	NA	> 3 years
Oxygen	99.9999%	11 bar, 160 psi	25 L/min	Inert carrier gas	NA	3,000 mL	NA	> 3 years
Hydrocarbons	99.9999%	11 bar, 160 psi	25 L/min	Inert carrier gas Air, H ₂	NA	NA	36 g (as n-butane)	> 3 years
Combination Moisture/Hydrocarbons	99.9999%	11 bar, 160 psi	25 L/min	Inert carrier gas He, Air, H ₂	10 g	NA	18 g (as n-butane)	> 2 years
Indicating Triple Moisture/Oxygen/Hydrocarbons	99.9999%	11 bar, 160 psi	25 L/min	Inert carrier gas He	3 g	400 mL	5 g (as n-butane)	> 1 year
Triple Moisture/Oxygen/Hydrocarbons	99.9999%	11 bar, 160 psi	25 L/min	Inert carrier gas	6 g	1,000 mL	12 g (as n-butane)	> 2 years

*Results @ 2 L/min



Stainless Steel Traps

Description	Part No.
Moisture Trap	N9306100
Oxygen Trap	N9306101
Hydrocarbons Trap	N9306102
Combination: Oxygen/Moisture Trap	N9306103
Combination: Moisture/Hydrocarbons Trap	N9306105
Triple: Oxygen/Moisture/Hydrocarbons Trap	N9306104
Triple Gas Specific (He): Oxygen/Moisture/Hydrocarbons	N9306106

Helium Specific Glass Indicating Triple Trap for your PerkinElmer Clarus GC/MS

This trap contains oxygen, moisture and hydrocarbons adsorbents in one trap and is packed and purged under helium.

The glass indicating trap clearly shows when the filter needs to be replaced with the use of color changes. The packing material is a silica-based environmentally friendly substitute for cobalt dioxide (blue) in the moisture indicator.

Available as a kit with the necessary 1/8" brass connectors, and as a replacement trap. This system is easy to install.

Description	Connector (Qty)	Part No.
Indicating Glass Triple Gas Specific (He): Oxygen/Moisture/Hydrocarbons	Not Included	N9306107
Indicating Glass Triple Gas Specific (He): Oxygen/Moisture/Hydrocarbons	1/8" Brass (2)	N9306114
Indicating Glass Triple Gas Specific (He): Oxygen/Moisture/Hydrocarbons	1/8" SS (2)	N9306116

Hydrocarbon Trap



	Part No.
Hydrocarbon Trap	N9301192

Use our activated charcoal in-line trap to remove gaseous hydrocarbons (C5 and heavier) from nitrogen, hydrogen and inert carrier gas supplies. Recommended for use with purge and trap apparatuses, high-sensitivity FID operations and with GC carrier gases for trace analyses. Frits in each end prevent particulates from entering the gas stream. Trap is shipped filled with helium. Maximum pressure is 1000 psi (69 bar). Dimensions are 5 x 37 cm including fittings. Weight is 1.0 kg.

High Capacity Hydrocarbon Trap



	Part No.
High Capacity Hydrocarbon Trap	N9301208

- Eliminates potential hydrocarbon background to insure best LC/MS results
- Contains 750 cc of preconditioned activated charcoal
- Stainless steel body. 1/4" brass compression fittings with ferrules for installation
- Maximum pressure 200 psi
- Recommended flow rate up to 2 Liters/minute
- Will remove hydrocarbon impurities (50 ppm or less) from inert gases, nitrogen and hydrogen at room temperature to low ppb range
- Capacity of 67 g. of hydrocarbons C5 and heavier
- 10 µm stainless steel porous frits protect gas stream from particulates
- Individually helium leak tested. Shipped filled with helium
- 2" OD x 20" L (including fittings)
- Weight 3.5 lb/1.6 kg

Indicating Oxygen Trap



	Part No.
Indicating Oxygen Trap	N9301191

This high-efficiency indicator trap reduces oxygen to less than 0.1 ppm. Changes color from bright green to gray when adsorption capacity is depleted. Oxygen capacity for this compact unit is 0.05 g at STP. The non-contaminating, heavy-wall inner glass tube of adsorbent is protected from breakage by the outer plastic tube. Maximum pressure is 100 psi (6.9 bar). Dimensions are 3.2 x 43 cm including fittings. Weight is 0.2 kg.

Oxygen Trap



	Part No.
Oxygen Trap	N9301179

This high-capacity, high-efficiency trap is used for long-term protection of capillary column stationary phases against oxidation at GC operating temperatures. Can remove 3.5 g of oxygen and has an output efficiency of less than 10 ppb oxygen concentration at the outlet. Effective at removing sulfur compounds, such as hydrogen sulfide and mercaptans. Intended for use with non-oxidizing gases such as He, Ar, N₂, H₂ or CH₄, containing less than 1% oxygen. The trap is filled with 500 cc of active oxygen adsorbent that binds covalently with oxygen; no gas is generated from this reaction. Maximum pressure is 1000 psi (69 bar). Dimensions are 5 x 37 cm including fittings, weight is 1.2 kg.

Safe Glass Moisture Trap



	Part No.
Safe Glass Moisture Trap	N9301193

Gas contacts only glass, metal and the adsorbents for purity. The Drierite® indicator and molecular sieve 5A are packed in glass protected by an outer plastic tube in the event that the glass breaks. Unique loading design allows operation in any orientation without channeling. Designed for GC detectors that require high-purity gases and recommended for ELCD and ECD systems where moisture and contamination are a problem. Maximum pressure is 100 psi (6.9 bar). Dimensions are 3.2 x 26 cm including fittings. Weight is 0.3 kg.

Gas In-line Filter



	Part No.
Gas In-line Filter	N9301178

The Gas In-line Filter Trap removes moisture, oil and dust from nitrogen or inert supply gases. It has 400 cc total volume of molecular sieve 5A and an indicator in a clear acrylic tube. The indicating Drierite® changes color at low relative humidity indicating that the packing must be changed. Base-plate version is available for free-standing orientation. Maximum pressure is 100 psi (6.9 bar). Dimensions are 6 x 43 cm including fittings. Weight is 1.0 kg.

PGX-H₂ Plus Pure Gas Hydrogen Generators

Pure gas hydrogen generators employ the newest membrane technology available for the safe production of pure hydrogen gas. This patented design is ideal for operation with gas analyzers, as fuel gas for flame tools, or as a source for pure hydrogen in plasma chambers and other isolated environments. Electrolytic membrane technology is preferred over alternative hydrogen generating techniques because it is clean, requires less maintenance and there is no need to store chemicals to maintain operation. The generators offer silent operation and require only deionized or distilled water with no caustic solutions which can affect the purity of the hydrogen.

Technical Specifications for PGX-H₂ Plus Models

Specifications	
Purity	99.999% / hydrocarbon free < 0.1 ppm
Delivery Pressure	20 - 1555 psig / 1.4 - 11 barg
Height	43 cm (16.9 in)
Width	23 cm (9.1 in)
Depth	36 cm (14.2 in)
Weight	20 kg (44 lbs)
Ambient Temperature Range	-20 °C to + 60 °C (-4 °F to + 140 °F)
Water Quality	Deionized or distilled <10 uS conductivity
Supply Voltage Range	230V/50-60Hz - 110V/60Hz - 100V/60Hz
Fitting	1/8" for the H ₂ outlet



PGX-H₂ Plus Generator Models

Flow Rate	Part No.
100 mL/min	N9308577
160 mL/min	N9308578
250 mL/min	N9308579
500 mL/min	N9308580
1000 mL/min	Not Available

PGX-H₂ Plus Generator Replacement Parts

Description	Part No.
Desiccant Cartridge, Fitting and Refill Kit	N9306064
Desiccant Refill (sufficient for 3 cartridge refills)	N9306065
Deionizer Bag	N9307097

NM-H₂ Plus Pure Gas Hydrogen Generators

A Safe Source of Hydrogen

Both the PGX-H₂ and the No Maintenance Hydrogen Generators have an auto shutoff procedure that places the units in standby in the event of an internal error and selectable alarms allow the user to be informed whenever operating conditions vary from the set point.

The No Maintenance (NM-H₂) Hydrogen Pure Gas Generators employ the newest membrane technology available for electrolytic production of pure hydrogen gas, including exclusive no maintenance auto-drying technology.

Technical Specifications for NM-H₂ Plus Models

Specifications	
Purity	99.9999% / hydrocarbon free < 0.1 ppm
Delivery Pressure	20 - 1555 psig / 1.4 - 11 barg
Height	43 cm (16.9 in)
Width	23 cm (9.1 in)
Depth	36 cm (14.2 in)
Weight	20 kg (44 lbs)
Ambient Temperature Range	-20 °C to + 60 °C (-4 °F to + 140 °F)
Water Quality	Deionized or distilled <10 uS conductivity
Supply Voltage Range	230V/50-60Hz - 110V/60Hz - 100V/60Hz
Fitting	1/8" for the H ₂ outlet

NM-H₂ Plus Generator Models

Flow Rate	Part No.
100 mL/min	N9308581
160 mL/min	N9308582
250 mL/min	N9308583
500 mL/min	N9308584
1000 mL/min	N9308585



NM-H₂ Plus Generator Accessories

Description	Part No.
I/O Board	N9307094
Cable for Cascading*	N9307093
Remote Control RS-232 (includes converter, cables and software)*	N9307095
Auto Refill *	N9307096

* Requires I/O Board

NM-H₂ Plus Generator Replacement Parts

Description	Part No.
Deionizer Bag	N9307097
Triangle Deionizer Bag	N9307098

High Purity Hydrogen Generators - Parker Domnick Hunter

The Parker Domnick Hunter high purity hydrogen gas generators offer the optimum combination of safe operation, reliability and performance. Utilizing field proven PEM cell technology, hydrogen is produced on demand from deionized water and electricity at low pressure and with minimal stored volume. Innovative control software allows unrivalled operational safety and reliability. These models ideally supply fuel gas to all known GC combustion detectors used in today's laboratory workflows.

Technical Specifications

Specifications	
Purity	99.999%
Delivery Pressure	5 - 100 psi/g
Height	46 cm (17.9 in)
Width	35 cm (13.5 in)
Depth	44 cm (17.2 in)
Weight	20 kg (41.9 lbs)
Ambient Temperature Range	+5 °C to +40 °C (+41 °F to +104 °F)
Water Quality	Deionized, ASTM® II, >1MΩ, <1 μS, filtered to <100 μm
Supply Voltage Range	Universal 120/230 V ± 10% (60/50 Hz)
Fitting	Hydrogen Outlet: 1/8" compression fitting Water Drain: quick release push in fitting



High Purity Generator Models

Flow Rate	Part No.
160 mL/min (20H Model)	N9303225
250 mL/min (40H Model)	N9303226
500 mL/min (60H Model)	N9303227
1000 mL/min	Not Available

Ultra High Purity Hydrogen Generators - Parker Domnick Hunter

The Parker Domnick Hunter high purity hydrogen gas generators offer the optimum combination of safe operation, reliability and performance. Utilizing field proven PEM cell technology, hydrogen is produced on demand from deionized water and electricity at low pressure and with minimal stored volume. Innovative control software allows unrivalled operational safety and reliability. These models ideally supply fuel gas to all known GC combustion detectors used in today's laboratory workflows.

Technical Specifications

Specifications	
Purity	99.99995%
Delivery Pressure	10 - 100 psi/g
Height	46 cm (17.9 in)
Width	35 cm (13.5 in)
Depth	47 cm (18.5 in)
Weight	21 kg (45.2 lbs)*
Ambient Temperature Range	+5 °C to +40 °C (+41 °F to +104 °F)
Water Quality	Deionized, ASTM® II, >1MΩ, <1 μS, filtered to <100 μm
Supply Voltage Range	Universal 120/230 V ± 10% (60/50 Hz)
Fitting	Hydrogen Outlet: 1/8" compression fitting Water Drain: quick release push in fitting

* 1100 mL/min model is 24 kg (51.8 lbs)

Ultra High Purity Generator Models

Flow Rate	Part No.
160 mL/min (20H-MD Model)	N9303201
250 mL/min (40H-MD Model)	N9303202
500 mL/min (60H-MD Model)	N9303203
1100 mL/min (110H-MD Model)	N9303204



Zero and Ultra Air Generators

The Zero and Ultra Zero Air Generators produce laboratory grade purified air for FID (flame ionization detectors) and other detectors. Designed with safety and convenience in mind, this system will generate purified and hydrocarbon free air from an existing in-house oil-free compressed air supply, eliminating the need for inconvenient high-pressure gas cylinders. Eliminating gas cylinders reduces annual operating costs associated with materials, labor, and down-time.

The Zero/Ultra Zero Air Generator series removes HC pollutants to less than 0.1 ppm, and all forms of particles. Operation of the generator requires low levels of electrical power consumption. This complete turnkey system is engineered with the highest quality components, is easy to install, and requires minimal annual maintenance. The Ultra Zero Air Generators will remove CO and HC pollutants to less than 0.1 ppm, and NO_x contaminants to 1 ppm. Carbon dioxide is also removed to about 1 ppm levels.

Specifications for Zero and Ultra Zero Air

Outlet Hydrocarbon Concentration	< 0.1 ppm
Outlet Carbon Monoxide Concentration	< 0.1 ppm
Outlet Particles < 0.5 Microns Removed	99.99%
Outlet Air Temperature	Ambient +15 °C
Max Inlet Hydrocarbon Concentration	100 ppm
Maximum Outlet Pressure	6.5 bar
Max Inlet Carbon Monoxide Concentration	50 ppm
Max Inlet Temperature	40 °C
Inlet Pressure Range (regulated to 7 bar)	4.5 – 10 bar
Inlet Port	¼" NPT
Outlet Port	⅛" NPT

Specifications for Zero Air

Outlet Zero Air	Maximum Continuous Output Flow Rate	Electrical Requirements	Temperature/ Pressure Control Board	Part No.
1.5 L/min	1.5 L/min	230/115 VAC 250 W max	N/A	N9307075
3.0 L/min	3.0 L/min	230/115 VAC 250 W max	Included	N9307076
6.0 L/min	6.0 L/min	230/115 VAC 250 W max	Included	N9307077
15.0 L/min	15.0 L/min	230/115 VAC 480 W max	Included	N9307078
30.0 L/min	30.0 L/min	230/115 VAC 480 W max	Included	N9307079

Dimension	Part No.
1.5 L/min of Air (Without Compressor)	N9307075
3.0 L/min of Air (Without Compressor)	N9307076
6.0 L/min of Air (Without Compressor)	N9307077
15.0 L/min of Air (Without Compressor)	N9307078
30.0 L/min of Air (Without Compressor)	N9307079



WALL MOUNTABLE

Ultra Zero Air Generators

Features and Benefits

- Flow rate: < 0.1 ppm HC; < 0.1 ppm CO; < 1 ppm NO_x; < 5 ppm CO₂
- Produce laboratory-grade purified air for the most accurate and convenient calibration of testing equipment
- Designed with safety and convenience in mind, this system will generate purified air from an existing in-house oil-free compressed air supply, eliminating the need for inconvenient high-pressure gas cylinders
- Eliminate gas cylinders reducing annual operating costs associated with materials, labor and downtime, and reduces risk of injury to workers
- Will remove CO and HC pollutants to less than 0.1 ppm and NO_x contaminants to 1 ppm. Carbon dioxide is also removed to about 1 ppm levels. Operation of the generator requires low levels of air consumption and electrical power
- Fully supported by PerkinElmer Service Organization

Specifications for Ultra Zero Air

Outlet Ultra Zero Air	Outlet Carbon Dioxide Concentration	Outlet Nitrogen Oxides Concentration	Outlet Dewpoint	Electrical Requirements	Part No.
1.5 L/min	< 5 ppm	< 0.1 ppm	< -70 °C	230/115 VAC 270 W max	N9307081
3.0 L/min	< 10 ppm	< 1 ppm	< -50 °C	230/115 VAC 270 W max	N9307082
6.0 L/min	< 10 ppm	< 1 ppm	< -50 °C	230/115 VAC 270 W max	N9307083
15.0 L/min	< 10 ppm	< 1 ppm	< -50 °C	230/115 VAC 500 W max	N9307080

Description	Part No.
1.5 L/min of Air (Without Compressor)	N9307081
3.0 L/min of Air (Without Compressor)	N9307082
6.0 L/min of Air (Without Compressor)	N9307083
15.0 L/min of Air (Without Compressor)	N9307080

All models come WITHOUT a compressor.
Oil Free Compressor Required.

GAS MANAGEMENT - ZERO AND ULTRA ZERO AIR GAS GENERATORS

Zero Air Generators - Parker Domnick Hunter

Parker Zero Air Gas Generators produce zero grade air from compressed air through catalytic oxidation. This zero air is used as an oxidant supply to GC-FIDs and as a zero-grade gas supply/zero reference gas for process analytical instruments. These generators produce zero-grade air with less than 0.05 ppm hydrocarbon content, measured as methane, enabling a more stable baseline as compared to conventional sources of fuel air.

Model	Flow Rate (L/min)	Air Inlet @ 58–145 psig (L/m)	Voltage	Part No. (120 V)
UHP-35ZA-S	3.5	4.2	120V	N9303206
UHP-35ZA-S	3.5	4.2	230V	N9303205
UHP-35ZA-S	5.0	6.0	120V	N9303208
UHP-35ZA-S	5.0	6.0	230V	N9303207
UHP-35ZA-S	15	18	120V	N9303210
UHP-35ZA-S	15	18	230V	N9303209
UHP-35ZA-S	30	35	120V	N9303212
UHP-35ZA-S	30	35	230V	N9303211

Size: 17.9" H x 13.4" W x 16.7" D

Weight: 31.3 lbs.

Organic Purity (ppm): <0.1

Delivery Pressure (psi/g): 58–145

Ambient Temperature Range: 41–104 °F

Required Inlet Air Quality:

Clean dry compressed air ISO8573-1:2001 Class 3.2.1

Supply Voltage Range: 120V/60 Hz or 230 V/50-60 Hz ±10%

Port Connections

Outlet (N9303205 and N9303206): 1/8" Compression Fitting

Inlet (N9303205 and N9303206): 1/8" Compression Fitting

Outlet (N9303207-N9303212): 1/4" Compression Fitting

Inlet (N9303207-N9303212): 1/4" Compression Fitting

ULTRA QUIET OIL FREE



PerkinElmer's GC Quiet Compressor

This industrial ultra quiet compact oil free 6 gallon compressor that can be utilized in the immediate laboratory area for the supply of clean air.

Horse Power: 0.60

Power Requirements: 115V/220V/50 – 60Hz

Output: 2.5 CFM

Output: 67 L/Min

Max Pressure: 100 PSI

Max Pressure: 7 bar

Operating Pressure PSI: 80 – 100

Operating Pressure Bar: 6 – 7

Noise Level: 62 db/A

Tank Size: 6.0 Gal.

Tank Size Liter: 24 L

Dimensions: 16 x 16 x 20 in.

Weight: 54 lbs.

Packed Dimensions: 19 x 18 x 23

Packed Weight: 58 lbs.

Features and Benefits:

- Ultra quiet for use in the laboratory area
- Compact size and light weight
- Commercial/Industrial grade
- 1 Year warranty on workmanship
- 5.0 micron pre-filter and regulator
- Internally powder coated air tank to prevent rust
- Pressure switch for automatic operation

Description	Part No.
115V 60Hz	N9306291
220V 60Hz	N9306292
220V 50Hz	N9306293



Ultra Quiet Compact Oil-free Compressor

PerkinElmer is expanding its product portfolio in response to customer requests for an industrial ultra quiet compact oil-free compressor that can be utilized in the immediate laboratory area for the supply of clean dry air. As with all PerkinElmer products, this 110 liter per minute air compressor has been rigorously tested to meet or exceed our industry leading standards.

Horse Power: 0.75

Power Requirements: 115V/220V/50 – 60Hz

Output: 4.4 CFM

Output: 110 L/Min

Max Pressure: 100 PSI

Max Pressure: 7 bar

Operating Pressure PSI: 80 – 100

Operating Pressure Bar: 6 – 7

Noise Level: 57 db/A

Tank Size: 1.57 Gal.

Tank Size Liter: 6 L

Dimensions: 34.7 x 13.4 x 22.4 in.

Weight: 103 lbs.

Packed Dimensions: 38 x 15 x 25

Packed Weight: 125 lbs.

Features and Benefits:

- Features a built-in desiccant dryer providing clean, dry, and particle free air at -40° F dew point
- Excellent for Gas Chromatography instrument applications with air generators applications
- Ultra quiet for use in the laboratory area
- Ease-of-use with built-in rolling casters and convenient handle
- Commercial/Industrial Grade
- 1 year warranty on workmanship

Description	Part No.
115V 60Hz	N9306350
220V 50Hz	N9306351
220V 60Hz	N9306352

Pressure Regulators

Ideally suited for chromatographic carrier gas applications including FID, TCD, ECD, HID, and non-corrosive gas mixtures for analytical instrumentation.



Specifications	Single Stage – Stainless Steel (Thread-less Seat) N9306353	Single Stage – Brass Nickel-plated (Thread-less Seat) N9306354
Max. Rated Inlet Pressure	1,250 psig	1,200 psig
Outlet Pressure Ranges	0-30, 0-60, 0-100, 0-250 psig	0-25, 0-50, 0-100, 0-250 psig
Flow capacity	Cv=0.066	Cv=0.15
Ambient Operating Temp.	-40° F to +165° F	-40° F to +165° F
Designed Leak Rate	2 x10-8 ccs (helium)	Bubble-tight (helium)
Weight	2 lbs	2.4 lbs
Ports (4)	¼" FNPT	¼" FNPT
Fittings	⅛"	⅛"
Inlet	⅛" FNPT	⅛" FNPT
Outlet	⅛" FNPT	⅛" FNPT
Decay Inlet Characteristic	N/A	0.23/100 psi
Materials		
Body	316 Stainless Steel	Nickel-Plated Brass
Bonnet	Nickel Plated Brass	Nickel Plated Brass
Seat	PCTFE®	PTFE
Diaphragm	Hastelloy C-22	316 Stainless Steel
Diaphragm Hastelloy C-22 Gauge	2½" Stainless Steel	N/A
Filter	316 Stainless Steel	316 Stainless Steel
Trim	316 Stainless Steel	Nickel Plated Brass
Gauges	N/A	2½" Stainless Steel
Valve Stem	N/A	316 Stainless Steel
Valve Spring	N/A	316 Stainless Steel

High-Purity Brass Regulators

PerkinElmer regulators are constructed of high-purity brass barstock and have stainless steel diaphragms and metal-to-metal seals. They are suitable for use with high-purity (>99.995% pure) non-corrosive gases. Regulators terminate in a ¼ in. NPT Swagelock fitting.



Features and Benefits

- Barstock body construction
- Stainless steel diaphragms
- Metal-to-metal seals
- Use with high-purity carrier gas

High-purity Brass Regulators (Dual Stage)

CGA Fitting	Delivery Pressure Use	Delivery Pressure Range (psig)	Cylinder Pressure Gauge (psig)	Gauge (psig)	Part No.
CGA-350	H2 and Ar/CH4	4 – 100	0 – 200	0 – 4,000	09907128
CGA-580	He, Ar, N2	4 – 100	0 – 200	0 – 3,000	09907127

High-purity Brass Regulators (Single Stage)

CGA Fitting	Delivery Pressure Use	Delivery Pressure Range (psig)	Cylinder Pressure Gauge (psig)	Gauge (psig)	Part No.
CGA-350	CO, H2 and Ar/CH4 Mixes	4 – 100	0 – 150	0 – 4,000	00230091
CGA-350	CO, H2	10 – 200	0 – 400	0 – 4,000	00230253
CGA-590*	Air	10 – 200	0 – 400	0 – 4,000	00230090

* Supplied with 590-580 Adapter.

GC Startup Kits

Description	Part No.
GC Startup Kit ⅛" Tubing and Fitting for (3) Gases	N9306304
Description.	Qty
⅛" Tubing x 50 foot coil Copper Special Cleaning	1
⅛" Compression Brass Tee Two Piece Ferrule Brass	3
Tee ⅛" Com x ⅛" Comp x ¼" fnpt Brass	3
Adjustable Safety Relief Valve Brass 50 – 150 PSI	3
¼" fnpt x ⅛" Comp Fitting Brass	3
⅛" Port Connector Brass	3
⅛" Ferrule Brass	3
⅛" Compression Brass Nut	3
⅛" Compression Brass Fitting Cap	3
Tubing Cutter ⅛" Tubing	1
PTFE Tape	1

Description	Part No.
GC Startup Kit ⅛" Tubing and Fitting With One Single Stage Regulator	N9306305
Description.	Qty
⅛" Tubing x 50 foot coil Copper Special Cleaning	1
⅛" Compression Brass Tee Two Piece Ferrule Brass	3
Tee ⅛" Com x ⅛" Comp x ¼" fnpt Brass	3
Adjustable Safety Relief Valve Brass 50 – 150 PSI	3
¼" fnpt x ⅛" Comp Fitting Brass	3
⅛" Port Connector Brass	3
⅛" Ferrule Brass	3
⅛" Compression Brass Nut	3
⅛" Compression Brass Fitting Cap	3
Tubing Cutter ⅛" Tubing	1
PTFE Tape	1
Single Stage Analytical 0 – 100 psig delivery, CGA 350 (H2, Carbon Monoxide, Ethylene)	1

Description	Part No.
GC Startup Kit ⅛" Tubing and Fitting With One Dual Stage Regulator	N9306306
Description.	Qty
⅛" Tubing x 50 foot coil Copper Special Cleaning	1
⅛" Compression Brass Tee Two Piece Ferrule Brass	3
Tee ⅛" Com x ⅛" Comp x ¼" fnpt Brass	3
Adjustable Safety Relief Valve Brass 50 – 150 PSI	3
¼" fnpt x ⅛" Comp Fitting Brass	3
⅛" Port Connector Brass	3
⅛" Ferrule Brass	3
⅛" Compression Brass Nut	3
⅛" Compression Brass Fitting Cap	3
Tubing Cutter ⅛" Tubing	1
PTFE Tape	1
Dual Stage Analytical 0 – 100 psig delivery, CGA 580 (N2, Argon, He)	1



Portable Gas Leak Detector

The new PerkinElmer compact handheld electronic gas leak detector is the ideal solution for detecting gas leaks in your Gas Chromatography systems. Leaks in your system waste gas and can cause detector noise, baseline instability, and shorter column life. This portable unit detects minute leaks of any gas with thermal conductivity different from air. The reference gas inlet draws in ambient air for comparison to air drawn into the sample probe. A leak is detected by both LED bar graph display and audible alarm.

Detectable Gases

Gas Type	Minimum Detectable Leak Rate (atm cc / sec)	Indicating LED Light Color
Helium	1.0×10^{-5}	Red
Hydrogen*	1.0×10^{-5}	Red
Nitrogen	1.4×10^{-3}	Yellow
Argon	1.0×10^{-4}	Yellow
Carbon Dioxide	1.0×10^{-4}	Yellow

Battery: Rechargeable Ni-MH internal battery pack (6 hours normal operation)

Universal Power Adapter Set: US, UK, European, Australian plugs included

Temperature Range: 32 – 120 °F (0 – 48 °C)

Humidity Range: 0 – 97%

Warranty: 1 Year

Certifications: CE, Japan

Compliance: WEEE, ROHS

Features and Benefits

- Sleek ergonomic, hand-held design with rugged side grips
- Automatic shut-off capabilities
- Optimized sample flow path
- LED readout and audible alarm

Description	Part No.
Portable Electronic Leak Detector	N9306089
Soft Carrying Case	N9306142
Probe (Fine Tip)	N9306063

* Caution: The PerkinElmer leak detector is not designed for determining leaks in a combustible environment. This unit may be used for determining trace amounts of hydrogen in a GC environment only.

ESSENTIAL GC LAB SUPPLIES

MiniTemp MT4 Non-contact Temperature Measurement with Laser Sighting

Features and Benefits

- Displays thermal measurement readings in °C or °F
- Easy point and shot infrared technology in a pocket size configuration
- Great for instrument thermal test confirmation, including GC injector port and detector measurements, thermostatted LC vials, and enzymatic hydrolysis baths



Specifications

Model	MiniTemp MT
Temperature Range	-18 to 400 °C (0 to 750 °F)
Distance to Spot Size (D:S)	8:1
Response time	500 m/sec
Emissivity	Pre-set at 0.95
Accuracy	±2%, or ±2 °C (±3 °F) whichever is greater
Typical Distance to Target (Spot)	Up to 1.5 m (4 ft)
Laser Sighting	Yes

The popular MiniTemp MT4 also includes single dot laser sighting to assist with aiming. 9 volt battery included. Recalibration is not available.

Description	Part No.
MiniTemp MT4	N9306074

Basic Tool Kit

Kit Includes: Open-end Wrench Set (6 pc), Screwdriver Set (6 pc.), Adjustable Wrench (6 in), Chain Nose Pliers (narrow), Wire Cutters, and Wire Strippers

Description	Part No.
Tools Come in a Tool Box for Easy Storage and Use	N9301327

Deluxe Tool Kit

Kit Includes: Open-end Wrench Set (6 pc.), Screwdriver Set (6 pc.), Adjustable Wrench (6 in), Chain Nose Pliers (narrow), Wire Cutters, Wire Strippers, Slip-joint Pliers (6 in), Long Nose No. 5 Stainless Steel Tweezers (4-3/8 inches), Needle File Set (6 pc.), Allen Key Set (11 pc. imperial sizes), and Allen Key Set (9 pc. metric sizes)

Description	Part No.
Shipped in a Plastic Tool Box for Convenient Storage	N9301328

Digital Bubble Flow Meter

The PerkinElmer Model 520 is a volumetric flow meter. It can measure the flow rate of any gas or combination of gases, such as air, without adjustment. The flow meter has a digital display and a single push-button input. It is made of stainless steel and anodized aluminum. It comes with a certificate of calibration, and is accurate to $\pm 3\%$. The Model 520 can measure flow rates of 0.5 to 500 mL/min.



Features and Benefits

- 0.5 to 500 mL/min flow rate with digital display
- Volumetric flow measurement
- Accurate to $\pm 3\%$ of measured flow rate

Description	Part No.
Digital Bubble Flow Meter	N9302974
Replacement Glass for Digital Bubble Flow Meter	N9303429

PerkinElmer Electronic Flowmeter 1000

The PerkinElmer Flowmeter 1000 allows for rapid real-time flow measurements. Flow rates measured in mL/min. (volumetric flow). The PerkinElmer Flowmeter 1000 can quickly calculate split ratios. Ratios are displayed in real time. Flowmeter not compatible with corrosive or flammable gases. Portable operation.

Features and Benefits

- Flow range 0.1–1,000 mL/min.
- Operating temperature 0 to 45 °C
- Traceable to NST primary standard
- Split ratio mode and accuracy $\pm 3\%$
- LCD alphanumeric display

Description	Part No.
PerkinElmer Electronic Flowmeter 1000	N9307029

Soap Bubble Flow Meters

The glass soap bubble flow meters are calibrated in 1 and 10 mL two-stage or 1, 10 and 100 mL three-stage for easy flow reading. Bubble meters come complete with liquid soap, rubber squeeze bulb, miscellaneous-sized plastic tube pieces to adapt to various fittings, and instructions.

Description	Part No.
Two-stage	00230522
Three-stage	N9300081

PerkinElmer FlowMark™ Electronic Flowmeter

PerkinElmer's FlowMark™ flowmeter is specifically designed for use with gas chromatography (GC) instruments. The probe is applied directly to the gas flow stream and the measured flow rate is presented on the LCD screen. Units of flow are measured in mL/min. This unit provides continuous real-time measurements of gas streams ranging from 0.50 mL/min to 500 mL/min. Because the technology uses volumetric flow measurement, the unit is compatible with all laboratory gases. The flowmeter is designed to measure clean, dry, non-corrosive gases.



Features and Benefits

- Measures volumetric flow for all gases across a range of 0.5–500 mL/min.
- NIST traceable calibration
- Explosion-proof rating for flammable and explosive gas atmospheres
- Accuracy of $\pm 2\%$ of flow or ± 0.2 mL/min., whichever is greater
- Over range indicator
- Auto shut-off feature
- Ergonomic design and side grips for comfort
- Measures most gas types
- Convenient storage case included
- CE, Ex (Compliance: WEEE, RoHS) certified
- Uses 2-AA batteries
- Data output via USB port
- Re-calibration service available
- Designed to measure clean, dry, non-corrosive gases
- 1 year warranty

Description	Part No.
FlowMark™ Electronic Flowmeter	N9307086
Recalibration service for flowmark flowmeter	N9307085
Soft Carrying Case	N9306142



PerkinElmer offers a wide selection of GC and GC/MS standards. Each solution is supplied with a comprehensive Certificate of Analysis that documents quality and assurance to the highest level obtainable by a Calibration Standard.

Organic Certified Reference Materials from PerkinElmer are a new addition to an already extensive organic product line designed to enhance your one-stop shopping experience. Each new standard is provided in convenient 1.2 mL ampules to minimize waste and comes with a pre-labeled amber glass storage vial with cap for easy use.

To ensure customer satisfaction, our Organic Mixes are prepared at concentration levels that take into consideration a number of factors including: vapor pressure, evaporation, breakdown rates and dilution schemes. PerkinElmer goes the extra step by analyzing each organic standard on the Clarus 600 GC and GC/MS state-of-the-art instrumentation to ensure that the standard conforms to the customer's exact needs.

For customer ease, all Organic Standards are prepared with a precision of +/- 0.5% and accompanied with a comprehensive Certificate of Analysis (lot specified by part number). Data packs are also available upon request. These include a chromatogram of the standard and quantitative report listing the values for each analyte.

Method 8260B for Water and Solid Waste Matrices

Method 8260B is an analytical method that uses a GC/MS equipped with a capillary column to perform the separation of the volatile organic compounds found in water and a variety of solid waste matrices.

Method 524.2 is an analytical method that uses a purge and trap device for sample preparation and a GC/MS equipped with a capillary column to perform the separation of volatile organic compounds.

Volatile Organics Combination Blend

Contains all analytes in Mixes A, C and D.

Method SW-846 is an analytical method which utilizes a Clarus 600 GC to perform the separation of the volatile organic components found in a variety of solid waste matrices. To detect the GC eluant a Clarus 600 GC/MS is used.

Description	Part No.
1.2 mL @ 2,000 µg/mL in P & T Methanol	N9331047

Method 8260B Standards

Description	Part No.
Alternate Four-Component Surrogate Standard for Method 8260B	
1.2 mL @ 2,000 µg/mL in P & T Methanol	N9331042
Internal Standard for Method 8260B	
1.2 mL @ 2,000 µg/mL in P & T Methanol	N9331041

Ketones for Method 8260B

Description	Part No.
1.2 mL @ 2,000 µg/mL in P & T Methanol	N9331043

Mix B Purgeable Gases for Methods 8260B/524.2

Description	Part No.
1.2 mL @ 2,000 µg/mL in P & T Methanol	N9331048

NEW

8000 Series Solid and Hazardous Waste Methods

Resource Conservation And Recover Act (Rcra) Under Sw-846, "Test Methods For Evaluating Solid Waste"

Features and Benefits

- Method 8080A contains detailed operating procedures to be followed by laboratories analyzing solid and liquid matrices. It is a method that uses a GC/ECD to perform the separation of the selected pesticides following concentration and clean up of an extract for aqueous or solid samples
- Method 8082 is used to determine the concentrations of PCB's, either as individual congeners or Aroclors by GC/ECD.

Method 8082 PCB's (polychlorinated biphenyls) Standards Kit

Method 8082 is used to determine the concentration of PCB's either as individual congeners or Aroclors. A Clarus 600 GC with a capillary column is used to perform the separation. To detect the eluent, an ECD (electron capture detector) or ELCD (electrolytic conductivity detector) is used.

Description	Part No.
1.2 mL @ 1,000 µg/mL in Hexane	N9331028

Method 8270C Standards

Method 8270C is an analytical method which utilizes a Methylene Chloride extraction of aqueous sample or Methylene Chloride: Acetone extraction of solid sample and a Clarus 600 GC equipped with a capillary column to perform the separation of the compounds. To detect the GC eluant a Clarus 600 GC/MS is used.

Description	Part No.
Semi-Volatile Calibration Standard for Method 8270C	
1.2 mL @ 1,000 µg/mL in Hexane	N9331030
Internal Standard for Method 8270C	
1.2 mL @ 2,000 µg/mL in Methylene Chloride/Benzene	N9331036

Method 8270C Mixes

Description	Part No.
HICAL-Acids Mix for Method 8270C	
1.2 mL @ 2,000 µg/mL in Methylene Chloride	N9331031
Analyte Mix for Method 8270C	
1.2 mL @ 2,000 µg/mL in Methanol	N9331032
Balance Mix for Method 8270C	
1.2 mL @ 2,000 µg/mL in Methylene Chloride	N9331033

Method 8270C Surrogates

Description	Part No.
Acid Surrogate for Method 8270C	
1.2 mL @ 2,000 µg/mL in Methanol	N9331037
Base Neutral Surrogate for Method 8270C	
1.2 mL @ 2,000 µg/mL in Methylene Chloride/Acetone	N9331038

600 Series Wastewater Methods Clean Water Act "Wastewaters"

Method 624 Standards Kit for Volatile Organic Compounds

Contains: N9331060, N9331061, N9331062, N9331063.

The U.S. EPA Method 624 is an analytical method which utilizes a TurboMatrix Headspace Purge and Trap instrument for sample prep and a Clarus 600 GC equipped with a packed column to perform the separation of the volatile organic compounds found in a 5 mL sample of municipal or industrial wastewater. To detect the eluant a Clarus 60 GC/MS is used.

Description	Part No.
1.2 mL @ 2,000 µg/mL in P & T Methanol	N9331064
Mix A for Method 624	
1.2 mL @ 2,000 µg/mL in P & T Methanol	N9331060
Purgeable Gases Mix B for Method 624	
1.2 mL @ 2,000 µg/mL in P & T Methanol	N9331061
Mix C for Method 624	
1.2 mL @ 2,000 µg/mL in P & T Methanol	N9331062
Mix D for Method 624	
1.2 mL @ 2,000 µg/mL in P & T Methanol	N9331063

Method 8100

Method 8100 is a method for the analysis of polynuclear aromatic hydrocarbons. A Clarus 600 GC is used to perform the separation of compounds with an FID (flame ionization detector) to detect the eluent.

Method 625

Method 625 is an analytical method that uses a methylene chloride extraction of municipal or industrial wastewater, concentrated to 1 mL and a GC/MS equipped to perform the separation of acid and base neutral extractable fractions.

Description	Part No.
Polynuclear Aromatic Hydrocarbons for Method 8100/625	
1.2 mL @ 2,000 µg/mL in Methylene Chloride/Benzene	N9331044
Polynuclear Aromatic Hydrocarbons Mix B for Method 8100	
1.2 mL @ 1,000 µg/mL in Methylene Chloride/Benzene	N9331045
Surrogate Standard for Method 8100	
1.2 mL @ 2,000 µg/mL in Methylene Chloride	N9331046

HUMAN HEALTH

ENVIRONMENTAL HEALTH



IR READY
FOR ANY
CHALLENGE



Reach new heights in IR with Frontier™. This innovative IR spectrometer combines superb sensitivity with optical flexibility, for superior performance in demanding applications. Offering optimized sampling options, Frontier satisfies any IR need and can be expanded as research goals develop. We've harnessed 65 years of expertise to create our most powerful, adaptable IR solution yet. Helping protect consumers and the environment more quickly and accurately than ever before.

www.perkinelmer.com/frontier



PerkinElmer
For the Better



MATERIALS CHARACTERIZATION



From the measurement of DNA purity to characterization of the most advanced engineered materials, we provide the widest range of solutions available from one company. FT-IR, FT-NIR, UV, UV/Vis, Fluorescence, DSC, TGA, STA, TMA, DMA — we have solutions for every lab and every budget.

Our expertise in these technology means you can rely on us. Do you need a simple accessory that provides results with a push of a button, or a high-end lamp with unparalleled sensitivity? What about flexible sample sizes and reduced sample setup time? Higher lab productivity? No problem.

Whatever challenge you face in material characterization, we can help you solve it. After all, we created the first commercial IR and FT-IR systems over 60 years ago. Since then, we have continually pioneered the technologies, consumables and supplies to help you learn more about the performance and structure of the materials you analyze at the molecular level.

Define your challenge, and we will help you meet it.

Infrared Spectroscopy

Accessories Overview	248-249
Application Packs	266
ATR Accessories	250-253
Desiccant and Laser Kits	263
Diffuse Reflectance Accessories	254
FT-NIR Accessories	267
Imaging Accessories	264
Oil Express Consumables	262
Portability Packs	262
Presses	261
Reference Materials	263
Sampling and Starter Kits	265
Specular Reflectance Accessories	255
Transmission Accessories	256-260

UV/Visible and Fluorescence

Cells	270-274
Cell Changers	276
Cell Holders	275
General Purpose Optical Bench	282
Fiber Optics	282
Fluorescence	284-289
Integrating Spheres	280
Lamps	268
Polarimetry	283
Polarizers, Depolarizers, Sipper	281
Reference Materials	269
Specular Reflectance Accessories	279
Thermostating Accessories	277-278

Thermal and Elemental Analysis

DMA Accessories and Supplies	296-297
DSC Supplies	290-292
Elemental Analysis Consumables	298-299
TGA / STA Supplies	294-295
TMA Supplies	293

IR READY FOR ANY SAMPLING CHALLENGE

Accessories play an important role in FT-IR analysis. Selection of the correct accessory speeds your analyses, increases repeatability of results and minimizes errors. We manufacture a host of high quality, easy-to-use accessories and partner with leading industry providers of branded IR accessories to provide a full range of compatible tools to extend the scope and capabilities of your FT-IR instrument.

From simple transmission spectroscopy techniques to more advanced research analysis, our premium “plug-and-play” accessories, such as UATR and diffuse reflectance, offer ultimate performance with minimum set-up and calibration through their convenient auto-recognition set-up design.



With the widest range of both PerkinElmer designed and manufactured accessories and well-known brands of accessories from our global partners, our selection offers you the best solution for your laboratory's needs.

INFRARED SPECTROSCOPY SAMPLING TECHNIQUES

Attenuated Total Reflectance (ATR)

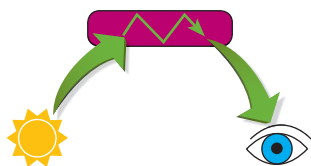

A sampling technique which requires little to no sample preparation. A beam of infrared light passes through the ATR crystal and is reflected off the surface of the sample. The reflection forms an evanescent wave which is collected by a detector.

SAMPLE TYPES: Solid, Liquid, Powder

APPLICATIONS: Identification of powders and polymers. Quantitative measurements for liquids, including aqueous solutions.

Diffuse Reflectance

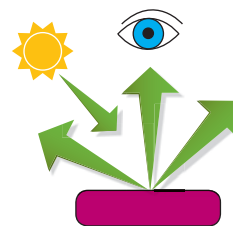

Diffusely scattered light is collected when a beam of light reflects off a rough, matt surface e.g. powder or fiber.

SAMPLE TYPES:
Powders, Fibers, Solids with Rough Surface

APPLICATIONS:
Characterization of minerals and hard plastic materials.

Whatever your application or instrument, we have the right sampling accessory for you.

Not every accessory is ideal for every application. That's why we offer a complete line of sampling options for your Spectrum One/100/400/65, Spectrum Two or Frontier instruments. With three different levels of sampling accessories to choose from, we'll help you find the solutions that best suit your laboratory needs.

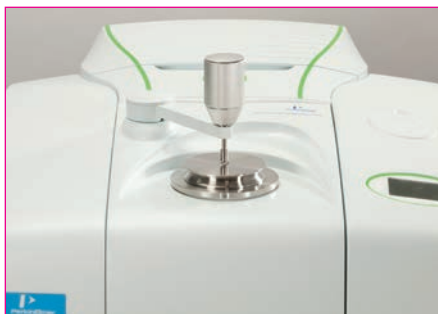

Premium: these top tier accessories offer you the most sampling flexibility. With "plug-and-play" accessory recognition and auto-alignment, you'll be able to quickly and easily analyze a wide range of sample types.



Branded: the quality of your instrument and that of the sampling accessory are equally important to your analysis. These mid-level accessories, manufactured by Specac, PIKE and others, have been tested and are approved for use on our PerkinElmer FT-IR systems.



Value: an affordable choice for laboratories that need a simple but effective sampling solution. With manual alignment, these accessories provide you with the performance you need to analyze most samples.

Specular Reflectance

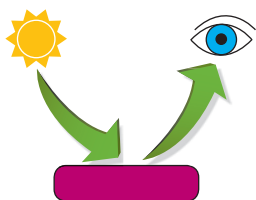

A mirror-like reflection occurs when a beam of light strikes a smooth, shiny surface such that the angle of incidence equals the angle of reflection.

SAMPLE TYPES: Thin Films on Substrates

APPLICATIONS: Analysis of coatings on metallic substrates, Langmuir Blodgett films and self-assembled monolayers.

Transmission

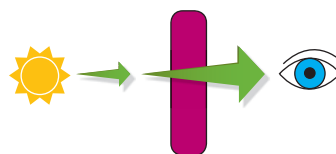

When radiation passes through a body a proportion of the energy is absorbed by the sample and the remainder travels on to the detector.

SAMPLE TYPES: Solid, Liquid, Gas

APPLICATIONS: Quantitative determination of fuel properties, e.g. biodiesel, high-resolution gas-phase spectroscopy

PerkinElmer UATR Accessory

PREMIUM



An excellent general accessory for the analysis of solids and liquids. The UATR produces high quality spectra through the use of a pressure arm allowing good contact of the sample with the diamond crystal. The pressure arm force indicator ensures first-class sample-to-sample and operator-to-operator reproducibility. The accessory is recognized when it is placed

in the sample compartment, the optics are automatically optimized and the system is ready to be used without additional alignment.

Description	Spectrum One/100/400/65	Spectrum Two	Frontier
UATR Diamond/ZnSe ATR (Single Reflection)	L1250050	L1600107	L1280301
UATR Diamond/KRS-5 ATR (Single Reflection)	L1250053		L1280304
UATR Germanium ATR (Single Reflection)	L1250054		L1280305
UATR Diamond/ZnSe ATR (3 Reflection)	L1250051		L1280302
UATR Diamond/ZnSe ATR (9 Reflection)	L1250052		L1280303
Liquid UATR Diamond/ZnSe (9 Reflection)			L1280069
UATR Pressure Arm O-Ring id: 3 mm; 1.5 mm CS N70, PK/12	L9004319	L9004319	L9004319

PerkinElmer HATR Accessory

PREMIUM

Available in Premium and Value versions this accessory is supplied with a top-plate fitted with a 25-reflection, 45 degree, 50 mm ZnSe crystal, allowing simple sampling of solids, films and powders.

Description	Spectrum One/100/400/65	Spectrum Two	Frontier
Premium HATR with ZnSe Flat Top Plate	L1200311		L1280308
Premium HATR with ZnSe Trough Top Plate	L1200312		L1280312
Value HATR with ZnSe Flat Plate		L1600113	L1280321
Value HATR with ZnSe Trough Plate		L1600109	L1280322

ATR Miracle Accessory (PIKE)

A single reflection HATR accessory designed for the analysis of highly absorbing solid, semi-liquid and liquid samples. The sampling plate configuration features a small round crystal allowing reliable analysis of small sample volumes.

Description	Spectrum One/100/400/65	Spectrum Two	Frontier
Miracle Diamond ATR (Single Reflection)		L1600114	L1272483
Miracle ZnSe ATR (Single Reflection)	L1272126	L1600115	L1272126
Miracle Ge ATR (Single Reflection)	L1272127	L1600116	L1272127

Multiple (10) reflection HATR Accessory (PIKE)

Provides high sensitivity for analysis of low concentration components in liquid, solid, and polymer samples. Available with a selection of crystal materials and high temperature configurations.

Description	Spectrum Two	Frontier Part No.
Multiple (10) Reflection HATR with ZnSe flat and trough plate	L1272337	L1272384

ATR Quest™

The Quest ATR Accessory is a single-reflection ATR accessory from Specac designed for laboratory spectroscopic sample analysis in the mid- and far-infrared. With innovative optical design and durable monolithic diamond ATR crystal option.

Description	Frontier Part No.
Quest ATR accessory with diamond top-plate	L1272503
Quest ATR accessory with diamond (extended range) top-plate	L1272504
Quest ATR accessory with ZnSe top-plate	L1272505
Quest ATR accessory with Ge top-plate	L1272506

Additional Quest Top-Plates

Description	Part No.
Quest ATR Diamond Crystal top-plate	L1272511
Quest ATR Diamond Extended Range Crystal top-plate	L1272512
Quest ATR ZnSe Crystal top-plate	L1272513
Quest ATR Ge Crystal top-plate	L1272514

Golden Gate™ ATR Accessory (Specac)

A high performance single reflection monolithic diamond ATR product offer, featuring a Type IIIA diamond ATR element metal-bonded into a tungsten carbide mount to provide outstanding durability and exceptional chemical resistance. The robust design allows this ATR accessory to be used to achieve high-quality spectral data in the analysis of a broad range of materials including those that are abrasive, hard, reactive, or corrosive.

Description	Frontier
Golden Gate™ Diamond ATR (Single Reflection)	L1272407

Gateway™ HATR Accessory (Specac)

An entry-level multi-reflection (6) horizontal ATR accessory. The rugged design and simple optical layout ensures optimum performance.

Description	Spectrum Two	Frontier
Gateway™ HATR with ZnSe flat and trough top plates	L1272330	L1272412
Gateway™ HATR with ZnSe with electrical heating to 200 °C. Requires Gateway controller (territory dependent)	L1272414	L1272414

25 Reflection ATR Accessory (Specac)

A vertically mounted ATR crystal accessory capable of being operated for a crystal incidence angle of between 30° to 60°. 25 Reflections are achieved at the 45° angle. The large number of reflections and range of incident angles makes this accessory ideally suited for the enhancement of small bands in weakly absorbing samples.

Description	Spectrum Two	Frontier
25 Reflection ATR Accessory with KRS-5 crystal	L1272372	L1272372

The GladiATR Vision™ (PIKE)

A sampling tool which couples small area infrared analysis with simultaneous viewing. Samples are placed face down and positioned on the diamond crystal while its image is projected in real-time on the LCD screen. Analysis of thick or non-transparent samples is enhanced because viewing is through the diamond crystal. The 110X magnification of the sample image enables the positioning of small samples for optimized analysis.

Description	Frontier
GladiATR Vision/Video/PC connection	L1272381
GladiATR Diamond	L1272423

The Variable Angle ATR (VATR) Accessory (PIKE)

This accessory has the ATR crystal mounted vertically and an optical layout is based on an optimized Gilby configuration and allows continuous adjustment of the incident beam angle between 30 to 60 degrees. Suitable for the analysis of solids, films and coatings. A unique mirror adjustment mechanism which utilizes mirror placement and proportional pivoting allows precise and repeatable alignment.

Description	Frontier
Classic VATR (25mm). Choose a 25mm crystal	L1272386
Classic VATR(50mm). Choose a 50mm crystal	L1272443

Crystal Type	25mm Crystal	50mm Crystal
KRS-5, 45° Parallelogram	L1272387	L1272388
KRS-5, 60° Parallelogram	L1272389	L1272390
ZnSe, 45° Parallelogram	L1272391	L1272392
ZnSe, 60° Parallelogram	L1272393	L1272394
Ge, 45° Parallelogram	L1272395	L1272396
Ge, 30° Parallelogram	L1272397	L1272398
Ge, 60° Parallelogram	L1272399	L1272400
Si, 45° Parallelogram	L1272401	L1272402

PERKINELMER ATR TOP PLATE ACCESSORIES

PerkinElmer ATR Top Plates & Options

Description	Part No.	Spectrum One/100/400/65	Frontier
UATR Top Plate Diamond/ZnSe (1 Reflection)	L1250240	✓	✓
UATR Top Plate Diamond/ZnSe (3 Reflection)	L1250241	✓	✓
UATR Top Plate Diamond/ZnSe (9 Reflection)	L1250242	✓	✓
UATR Top Plate Diamond/KRS5 (1 Reflection)	L1250046	✓	✓
UATR Top Plate Ge (1 Reflection)	L1250048	✓	✓
UATR 3.0mm Sample Position Plate (for 1 and 3 reflection UATR's)	L1202023	✓	✓
UATR 7.0mm Sample Position Plate (for 1 and 3 reflection UATR's)	L1202024	✓	✓
UATR Polarization Accessory Diamond/ZnSe (1 Reflection Top-Plate and Pressure Arm)	L1280064		✓
UATR Polarization Accessory Diamond/ZnSe (3 Reflection Top-Plate and Pressure Arm)	L1280065		✓
UATR Polarization Accessory Diamond/ZnSe (9 Reflection Top-Plate and Pressure Arm)	L1280066		✓
UATR Heated Top plate 60°C (Requires Pike Miracle ATR/10 Reflection HATR USB Temperature Controller)	L1272380		✓
UATR Heated Top plate 130°C (Requires Pike Miracle ATR/10 Reflection HATR USB Temperature Controller)	L1272433		✓
Universal 0.5mm ATR Shoe With 1.5mm diameter tip (for 1 and 3 reflection UATR's)	L1202049	✓	✓
Universal 6.0mm ATR Shoe With 6.0mm flat end (for 1 and 3 reflection UATR's)	L1202050	✓	✓
UATR Cone Shoe (for 1 and 3 reflection UATR's)	L1201980	✓	✓
Premium HATR ZnSe 45 Degree Flat Plate	L1200313	✓	✓
Premium HATR ZnSe 45 Degree Trough Plate	L1200314	✓	✓
Premium HATR ZnSe 60 Degree Flat Plate	L1200315	✓	✓
Premium HATR ZnSe 60 Degree Trough Plate	L1200316	✓	✓
Premium HATR (Coated for extended lifetime) ZnSe 45 degree flat plate	L1200323	✓	✓
Premium HATR (Coated for extended lifetime) ZnSe 45 degree trough plate	L1200324	✓	✓
Premium HATR (Coated for extended lifetime) ZnSe 60 Degree Flat Plate	L1200325	✓	✓



Description	Part No.	Spectrum One/100/400/65	Frontier
Premium HATR Ge 30 Degree Flat Plate	L1200337	✓	✓
Premium HATR Ge 30 Degree Trough Plate	L1200338	✓	✓
Premium HATR Ge 45 Degree Flat Plate	L1200333	✓	✓
Premium HATR Ge 45 Degree Trough Plate	L1200334	✓	✓
Premium HATR Ge 60 Degree Flat Plate	L1200335	✓	✓
Premium HATR Ge 60 Degree Trough Plate	L1200336	✓	✓
Premium HATR AMTIR 45 Degree Flat Plate	L1200343	✓	✓
Premium HATR AMTIR 45 Degree Trough Plate	L1200344	✓	✓
Premium HATR AMTIR 60 Degree Flat Plate	L1200345	✓	✓
Premium HATR AMTIR 60 Degree Trough Plate	L1200346	✓	✓
Premium ATR Pressure Arm Kit	L1200321		✓
Premium Powder press	L1201944		✓
Premium Volatiles cover	L1205436		✓

Description	Part No.	Spectrum Two	Frontier
Value HATR ZnSe Trough Plate	L1360266	✓	✓
Value HATR ZnSe Flat Plate	L1360267	✓	✓
Value HATR Ge Trough Plate	L1360268	✓	✓
Value HATR Ge Flat Plate	L1360269	✓	✓
Value HATR AMTIR-1 Trough Plate	L1360270	✓	✓
Value HATR AMTIR-1 Flat Plate	L1360271	✓	✓
Value HATR KRS-5 Trough Plate	L1360272	✓	✓
Value HATR KRS-5 Flat Plate	L1360273	✓	✓
Value HATR Clamp Assembly	L1360275	✓	✓

Pike ATR Top Plates & Options

Description	Part No.	Spectrum One/100/400/65	Spectrum Two	Frontier
Miracle ZnSe Top Plate	L1272130	✓	✓	✓
Miracle Ge Top Plate	L1272131	✓	✓	✓
Miracle Si Top Plate	L1272133	✓	✓	✓
Miracle Diamond/ZnSe composite Top Plate	L1272313	✓	✓	✓
Miracle Heated 60°C Diamond/ZnSe Crystal Plate*	L1272314		✓	✓
Miracle Heated ZnSe Crystal Plate*	L1272315		✓	✓
Miracle Heated 130°C Ge Crystal Plate*	L1272316		✓	✓
Miracle Volatiles Cover	L1272320	✓	✓	✓
Miracle Liquid Retainer with Volatiles Cover	L1272321	✓	✓	✓
Miracle Flat tip for high pressure clamp	L1272323	✓	✓	✓
Miracle swivel tip for high pressure clamp	L1272324	✓	✓	✓
Miracle Concave tip for high pressure clamp	L1272325	✓	✓	✓
Multiple (10) Reflection HATR ZnSe Trough Plate	L1272338		✓	✓
Multiple (10) Reflection HATR ZnSe Flat Plate	L1272339		✓	✓
Multiple (10) Reflection HATR Ge Trough Plate	L1272340		✓	✓
Multiple (10) Reflection HATR Ge Flat Plate	L1272341		✓	✓
Multiple (10) Reflection HATR Heater with ZnSe Trough plate*	L1272342		✓	✓
GladiATR Heated ATR Diamond up to 210°C**	L1272422			✓
GladiATR Ge Crystal Plate	L1272425			✓
Miracle ATR/10 Reflection HATR USB Temperature Controller (220V, UK)	L1272317		✓	✓
Miracle ATR/10 Reflection HATR USB Temperature Controller (220V, Euro)	L1272318		✓	✓
Miracle ATR/10 Reflection HATR USB Temperature Controller (110V, 60Hz)	L1272319		✓	✓
GladiATR USB Temperature Controller (220V, UK)	L1272426			✓
GladiATR USB Temperature Controller (220V, Euro)	L1272427			✓
GladiATR USB Temperature Controller (110V, 60Hz)	L1272428			✓

* Requires L1272317, L1272318 or L1272319

** Requires L1272426, L1272427 or L1272428

Specac ATR Top Plates & Options

Description	Part No.	Spectrum One/100/400/65	Spectrum Two	Frontier
Silver Gate™ ZnSe Flat Top Plate (Single Reflection)	L1272274	✓	✓	✓
Silver Gate™ ZnSe Recessed Top Plate (Single Reflection)	L1272276	✓	✓	✓
Silver Gate™ Ge Flat Top Plate (Single Reflection)	L1272275	✓	✓	✓
Silver Gate™ Ge Recessed Top Plate (Single Reflection)	L1272277	✓	✓	✓
Gateway HATR ZnSe Electrically Heated Top Plate to 200°C (220V, UK)	L1272331		✓	
Gateway HATR ZnSe Electrically Heated Top Plate to 200°C (220V, Europe)	L1272373		✓	
Gateway HATR ZnSe Electrically Heated Top Plate to 200°C (110V, 60Hz)	L1272374		✓	
Gateway ZnSe 45 Degree Flat Top-Plate	L1272332		✓	✓
Gateway Ge 45 Degree Flat Top-Plate	L1272333		✓	✓
Gateway ZnSe 550µl Flow Through 45 Degree Top Plate	L1272334		✓	✓
Gateway ZnSe Thermocirculating 550µl flow through top plate	L1272335		✓	✓
Gateway ZnSe Water Heated/Cooled 45 Degree Top-plate	L1272336		✓	✓
Gateway™ UK Controller	L1272484			✓
Gateway™ Euro Controller	L1272485			✓
Gateway™ USA Controller	L1272486			✓
Gateway™ China Controller	L1272487			✓

Diffuse Reflectance Accessories



PREMIUM

PerkinElmer Diffuse Reflectance Accessory

Available in Premium and Value versions this accessory provides a convenient and sensitive method for analyzing opaque or highly scattering solid samples such as pharmaceuticals, food products, soap powders, coal, clay, soil, paper, painted surfaces, polymer foam and catalysts. The accessory allows for macro or micro sampling and only requires insertion into the sample compartment to be ready to use.

Description	Spectrum One/100/400/65	Spectrum Two	Frontier
Premium Diffuse Reflectance Accessory			L1280306
Value Diffuse Reflectance Accessory	L1200351	L1600111	L1280323

EasyDiff Diffuse Reflectance Accessory (PIKE)

A reflectance accessory with pre-aligned optical components and micrometer controlled sample positioning for reproducible, high quality data.

Description	Spectrum Two
EasyDiff Diffuse Reflectance Accessory	L1272344

DiffusIR™ Diffuse Reflectance Accessory (PIKE)

A research grade diffuse reflectance accessory with a large, efficient optical design accommodating optional environmental chambers for thermodynamic studies.

Description	Frontier
DiffusIR Diffuse Reflectance Accessory	L1272403

Selector™ Diffuse Reflectance Accessory (Specac)

For analysis of powdered and solid samples. An environmental chamber option allows enhanced vacuum, temperature and pressure studies.

Description	Frontier
Selector Diffuse Reflectance Accessory	L1272409
Selector Diffuse Reflectance Accessory with Environmental Chamber	L1272410

Mid & NIR Integrating Spheres (PIKE)

Mid-IR and NIR sample compartment spheres for reflectance measurements. Samples are placed directly onto the sample port of the upward-looking sphere or over a thin infrared transmitting window. Measurement of diffuse transmission may also be done by placing the sample at the slide mount beam input port. Kits

include base optics, MCT detector (MIR) or InGaAs detector (NIR), and base mount.

Description	Frontier
Mid-IR Integrating Sphere with ZnSe Windows	L1272405
NIR Integrating Sphere with KBr Windows	L1272406

Diffuse Reflectance Options

PerkinElmer Diffuse Reflectance Options

Description	Part No.	Spectrum One/100/400/65	Spectrum Two	Frontier
Diffuse Reflection Macrosample Cup	L1201654	✓	✓	✓
Diffuse Reflection Microsample Cup	L1201655	✓	✓	✓
Diffuse Reflection Multi-Purpose Sample Holder	L1201865	✓	✓	✓
Diffuse Reflection Metal-Coated Silicon Carbide Abrasive Pads, Pack of 100	L1275106	✓	✓	✓
Diffuse Reflection Non-Coated Silicon Carbide Abrasive Sticks, Pack of 100	L1271021	✓	✓	✓
Diffuse Reflection Metal-Coated Diamond Abrasive Sticks, Pack of 100	L1275105	✓	✓	✓
Diffuse Reflection Non-Coated Diamond Abrasive Sticks, Pack of 100	L1275102	✓	✓	✓

Pike Diffuse Reflectance Options

Description	Part No.	Spectrum Two	Frontier
EasyDiff Small Sample Cup, 2 Per Package	L1272345	✓	
EasyDiff Large Sample Cup, 2 Per Package	L1272346	✓	
EasyDiff Sample Slide	L1272347	✓	
EasyDiff Silicon Carbide Abrasive Disks, Pack of 100	L1272348	✓	
EasyDiff Diamond Abrasive Disks, Pack of 50	L1272349	✓	
EasyDiff Sample Cup Holder and Base	L1272350	✓	
EasyDiff EasiPrep Sample Preparation Kit	L1272351	✓	
EasyDiff Alignment Mirror	L1272352	✓	
EasyDiff Abrasion Kit	L1272375	✓	
DiffusIR Heating options. Requires DiffusIR Temperature Controller (territory dependent)	L1272344		✓
DiffusIR Environmental Chamber (900°C)	L1272458		✓
DiffusIR Environmental Chamber (500°C)	L1272459		✓
DiffusIR temperature controller for environmental chambers (220V, UK)	L1272461		✓
DiffusIR temperature controller for environmental chambers (220V, Euro)	L1272462		✓
DiffusIR temperature controller for environmental chambers (110V, 60Hz)	L1272463		✓

Specular Reflectance Accessories

PerkinElmer Fixed Angle Specular Reflectance Accessory

This accessory allows measurements on samples with glassy coatings and reflective surfaces. The sample is mounted horizontally and can be measured using 2, 5 or 10mm apertures (included).

Description	Spectrum One/100/400/65	Spectrum Two	Frontier
Fixed Angle (16 degree) Specular Reflectance Accessory	01860796	L1600119	01860796

PerkinElmer Variable Angle Specular Reflectance Accessory

This accessory allows measurement of reflectance spectra at angles of incidence between 15 and 80 degrees. Provides high-quality, non-destructive routine measurements of glossy, non-scattering flat surfaces or coatings on highly reflective substrates. At high angles, very thin films or coating may be measured.

Description	Frontier
Variable Angle Specular Reflectance Accessory	01860954

80Spec Grazing Angle Specular Reflectance Accessory (PIKE)

For the measurement of relatively thin films and mono-molecular layers. Samples are laid face down and the spectrum of the film is measured. Includes base optics, sample masks, polarizer mounts.

Description	Spectrum One/100/400/65	Spectrum Two	Frontier
80Spec Grazing Angle Specular Reflectance Accessory	L1272248	L1272248	L1272248

10Spec™ Specular Reflectance Accessory (PIKE)

Recommended to measure the reflectivity of glass per ASTM Standard E1585-93. May also be used to measure near-normal reflectivity of a wide variety of surfaces including military devices, reflecting optics, anti-reflective (AR) coated surfaces, and other reflecting and non-reflecting materials.

Description	Spectrum One/100/400/65	Spectrum Two	Frontier
10Spec Specular Reflectance Accessory	L1272247	L1272361	L1272247

VeeMAX™ II Variable Angle Accessory (PIKE)

Can be used as a specular reflectance or ATR accessory in both single and multiple reflection mode. The angle may be varied continuously from 30 to 80 degrees by the rotation of a single control. Has a built-in polarizer mount to permit selection of polarization angle without disturbing purge.

Description	Spectrum One/100/400/65	Frontier
VeeMAX II Variable Angle Specular Reflectance Accessory	L1272240	L1272240
VeeMAX II Variable Angle Specular Reflectance ATR Accessory		L1272382
ATRMax II Variable HATR accessory with 45 degree ZnSe Trough Plate		L1272383

Pike Specular Reflectance Options

Description	Part No.	Spectrum One/100/400/65	Spectrum Two	Frontier
80Spec/VeeMAX KRS-5 Polarizer	L1272243	✓	✓	✓
80Spec ZnSe Manual Polarizer	L1272376	✓	✓	✓
80Spec/10Spec Gold Reflectance Mirror	L1272377	✓	✓	✓
VeeMax ZnSe 45 degree flat plate	L1272450	✓		✓
VeeMax ZnSe 60 degree flat plate	L1272451	✓		✓
VeeMax Ge 45 degree flat plate	L1272452	✓		✓
VeeMax Ge 60 degree flat plate	L1272453	✓		✓
VeeMax Ge 65 degree flat plate	L1272454	✓		✓
ATRMax II Variable Angle Multiple reflection ATR, 45 deg ZnSe crystal	L1272455	✓		✓
ATRMax Ge 45 degree trough plate	L1272456	✓		✓
ATRMax Ge 45 degree flat plate	L1272457	✓		✓

WIDE SELECTION OF SAMPLING CELLS AND WINDOW MATERIALS

PerkinElmer offers a versatile product line of liquid sampling cells which utilize a specially designed Universal mount suitable for both FT-IR and dispersive instruments, and a wide variety of high-quality window materials to meet your analytical needs. These windows are polished to precise tolerances of flatness.

The first criteria to consider when selecting a window material is the wavelength range over which the spectrum must be measured.

Other important considerations include solubility, reactivity, and the refractive index of the window material with respect to the sample. Sometimes mechanical and thermal characteristics may also be important.

Selecting Window Materials

The following information may be helpful in selecting window materials:

- **Sodium Chloride (NaCl)** is one of the most versatile window materials available, due to its spectral range and low cost. Samples should not contain water because NaCl is hygroscopic. This will cause the windows to fog and become unusable. Store NaCl cells in a desiccator when not in use. NaCl withstands mechanical stress and can be used up to 400 °C.
- **Potassium Bromide (KBr)** has a slightly wider spectral range than NaCl but is more hygroscopic. Although able to provide good resistance to mechanical shock, KBr is easily cleaved. KBr can be used up to 300 °C.
- **Calcium Fluoride (CaF₂)** is extremely hard and stable. CaF₂ is not significantly affected by moisture and does not fog. While resistant to most acids and bases, CaF₂ should not be used with ammonium salts.
- **Barium Fluoride (BaF₂)** is a relatively hard material, similar to CaF₂. Though less resistant to water than CaF₂, BaF₂ has a wider spectral range. The useful temperature range extends to 500 °C. Also, BaF₂ should not be used with ammonium salts.
- **Thallium Bromide-Iodide (KRS-5)** has a broad spectral range and a high refractive index, making it ideal for internal reflectance accessories. KRS-5 is slightly soluble in water and bases but insoluble in acids; KRS-5 is toxic and should not be repolished.
- **Silver Bromide (AgBr)** is easily scratched and has a tendency to cold flow at room temperature. Although only minimally degraded by water, AgBr will corrode after prolonged contact with moisture and metals. Avoid exposure to ultraviolet lights, as the crystal has a tendency to darken.
- **Zinc Selenide (Irtran-4™)** is similar to Cleartran except that it is somewhat softer and more easily scratched. Irtran-4 is used in total reflectance accessories because of its high refractive index.

Window Material	Transmission Range μm	Transmission Range cm^{-1}	Refractive Index at 1,000 cm^{-1}	Solubility G/100 G H ₂ O at 20 °C
Sodium Chloride, NaCl	0.25 – 16	40,000 – 625	1.49	36.0
Potassium Bromide, KBr	0.25 – 26	40,000 – 385	1.52	65.2
Potassium Chloride, KCl	0.25 – 20	40,000 – 500	1.46	34.7
Cesium Iodide, CsI	0.30 – 50	33,000 – 200	1.74	160.0 (at 61 °C)
Fused Silica, SiO ₂	0.20 – 4	50,000 – 2,500	1.42 (at 3,333 cm^{-1})	Insoluble
Calcium Fluoride, CaF ₂	0.20 – 9	50,000 – 1,100	1.39 (at 2,000 cm^{-1})	1.51 x 10 ³
Barium Fluoride, BaF ₂	0.20 – 13	50,000 – 770	1.42	0.12 (at 25 °C)
Thallium Bromide-Iodide, KRS-5	0.60 – 40	16,600 – 250	2.37	< 4.76 x 10 ⁻²
Silver Bromide, AgBr	0.50 – 35	20,000 – 285	2.00	12 x 10 ⁻⁶
Zinc Sulfide, ZnS (Cleartran)	1.0 – 14	10,000 – 715	2.20	Insoluble
Zinc Selenide, ZnSe (Irtran-4)	1.0 – 19.5	10,000 – 515	2.41	Insoluble
Polyethylene (high-density)	16 – 333	625 – 30	1.54 (at 5,000 cm^{-1})	Insoluble

Crystal Polishing Kit

Fogged windows are quickly restored with the infrared crystal polishing kit. The kit contains everything necessary to repolish sodium chloride, potassium bromide, or cesium iodide windows, and includes a smoothing lap, polishing rouge, a sponge, an optical flat, a Selvyt cloth, and a booklet describing the repolishing technique.

Description	Part No.
Crystal Polishing Kit	51001188

Replacement Parts for the Crystal Polishing Kit

Description	Part No.
Selvyt Cloth (pkg. 5)	51001324
Glass Grinding Lap	51001325
Optical Lap	51001326
Cleaning Sponge (pkg. 2)	51001327
Tin Polishing Rouge, 56 g	51001328
Polishing Lap Glass Plate	51001329

Demountable Cells and Windows



FOR MULLS, CAPILLARY FILMS, CAST FILMS, AND VERY VISCOUS LIQUIDS

Circular windows are used to construct a demountable cell where the sample is placed on one window and the second window is pressed lightly on top of the first. Spacers of various thicknesses can be used to vary the cell pathlength.

Demountable Cell

Description	Part No.
Universal Demountable Cell	L1270986
1 Window Aligner	04821132
2 Neoprene™ Gasket	L1270512
3 Circular Window (see below)	
4 Spacer (see below)	
5 PTFE Plugs (pkg. 6)	04821008
6 Quick Release Nut	04821131

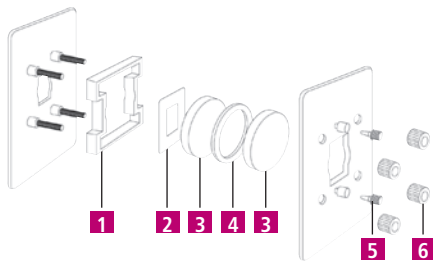

Semi-demountable Cells and Windows

FOR HIGH-VISCOSITY LIQUIDS OR MULL SAMPLES

By using rectangular windows instead of circular windows, the demountable cell becomes a semi-demountable cell. The semi-demountable cell can be used either as a demountable cell or as a sealed cell for high-viscosity liquids or mull samples. To order a semi-demountable cell, order the Universal Demountable Cell (L1270986) and your choice of semi-demountable windows and spacers.

Description	Part No.
1 Window Aligner	04821132
2 Neoprene™ Gasket	L1270512
3 Undrilled Window (see below)	
4 Spacer (see below)	
5 Drilled Window (see below)	
6 PTFE Plugs (pkg. 6)	04821008
7 Quick Release Nut	04821131

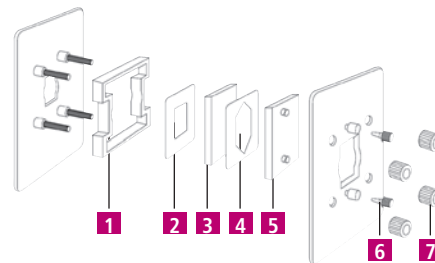

Circular Demountable Cell Windows (Pair)

Window Material	Diameter	Thickness	Part No.
Sodium Chloride	25 mm	4 mm	L1271102
Potassium Bromide	25 mm	4 mm	L1271202
Calcium Fluoride	25 mm	4 mm	L1271602
Barium Fluoride	25 mm	4 mm	L1272002
Thallium Bromide-Iodide	25 mm	4 mm	L1270665
Silver Bromide	25 mm	2 mm	L1272102
Zinc Selenide	25 mm	2 mm	L1270766

Rectangular Semi-demountable Cell Windows (1 drilled; 1 undrilled)

Window Material	Thickness	Part No.
Sodium Chloride	4 mm	L1271191
Potassium Bromide	4 mm	L1271192
Calcium Fluoride	4 mm	L1271193
Barium Fluoride	4 mm	L1271194
Cesium Iodide	4 mm	L1271195
Zinc Selenide	2 mm	L1270765
Silver Bromide	2 mm	L1270666
Thallium Bromide-Iodide	2 mm	L1270664

Circular Spacers

Spacer Material	Thickness	Qty.	Part No.
Lead	0.025 mm	10	L1271250
PTFE*	0.05 mm	10	51001135
PTFE*	0.1 mm	6	51001137
PTFE*	0.2 mm	3	51001140
PTFE*	0.5 mm	3	51001141

* PTFE spacers can be used for the analysis of less viscous samples.

Rectangular Spacers

Spacer Material	Thickness	Qty.	Part No.
Lead	0.025 mm	10	L1270301
PTFE	0.05 mm	6	L1270402
PTFE	0.1 mm	6	L1270404
PTFE	0.2 mm	3	L1270408
PTFE	0.5 mm	3	L1270409
PTFE	1 mm	3	L1270410
Assorted (2 of each)			L1270421

Sealed Liquid Cells

FOR HIGHLY VOLATILE SAMPLES AND QUANTITATIVE ANALYSIS

The sealed liquid cells have a corrosion-resistant construction making them ideal for highly volatile samples. The sealed liquid cells are ideal for quantitative analysis where you require an accurate reproducible cell thickness. These cells use a lead spacer which is amalgamated to the window material. The resultant bond forms a good leak-free seal which is effective in preventing evaporation and loss of sample. The sealed liquid cell is an integral unit and cannot be disassembled.

The sample filling orifice is compatible with Luer-Lok™ hypodermic syringes. Two syringes are recommended when cleaning the cell. Never use viscous materials which are difficult to remove from a sealed liquid cell. Instead, use a semi-demountable cell.



Sealed Cell

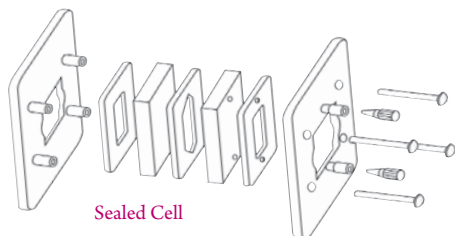

Sealed Cell

Rectangular Sealed Liquid Cells

Window Material	Pathlength	Part No.
Sodium Chloride	0.025 mm	L1270941
	0.05 mm	L1270942
	0.1 mm	L1270944
	0.2 mm	L1270947
	0.5 mm	L1270948
	1 mm	L1270949
Potassium Bromide	0.025 mm	L1270951
	0.05 mm	L1270952
	0.1 mm	L1270954
	0.2 mm	L1270957
	0.5 mm	L1270958
	1 mm	L1270959
Calcium Fluoride	0.025 mm	L1270961
	0.05 mm	L1270962
	0.1 mm	L1270964
	0.2 mm	L1270967
	0.5 mm	L1270968
	0.1 mm	L1270969
Zinc Selenide	0.1 mm	L1270970

Description	Part No.
Luer-Lok Syringe for Sealed Liquid Cells	04967845

Press-N-Lock Demountable Cell and Windows

FOR SIMPLE ANALYSIS OF MULLS, SMEARS, AND VISCOUS FILMS

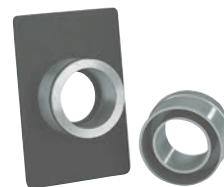

The Press-N-Lock Demountable Cell lets you analyze mulls, smears, viscous films, etc., without the use of nuts, springs, or bolts to keep the cell together. You can use this cell on any PerkinElmer FT-IR spectrometer. The cell consists of a backplate with a Viton™ O-Ring that lets you slip the cover on and off with ease.

Description	Part No.
Press-N-Lock Demountable Cell	N9302642
O-Rings 25 mm (pkg. 12).	N9302643

Press-N-Lock Demountable Cell Windows (Pair)

Window Material	Diameter	Thickness	Part No.
NaCl	25 mm	4 mm	L1271102
KBr	25 mm	4 mm	L1271202
BaF ₂	25 mm	4 mm	L1272002
ZnSe	25 mm	2 mm	L1270766
CaF ₂	25 mm	4 mm	L1271602

FT-NIR Liquid Cells and Holders

A comprehensive range of FT-NIR cells are available for use with PerkinElmer FT-NIR's and can be found in the cells listing included in the UV section of this catalog.

Description	Lightpath	Part No.
Cylindrical cell holder	10 mm	L1181303
Cylindrical cell holder	50 mm	N9302620
Cylindrical cell holder	100 mm	N9302640
Rectangular cell holder	50 mm	02200550

Beam Condenser

Baseplate mounted for high performance transmission measurements of microsamples and gemstones. Horizontal sample platform for easy sample placement. Compatible with diamond anvil cell accessory. Includes a range of sample apertures 0.5 mm – 2.5 mm, and alignment tool.

Description	Part No.
Spectrum Two Beam Condenser	L1600130

Short path demountable gas cells

Used to monitor air pollutants, study vapor phase transitions in gas molecules and quantify impurities in gas samples. The Pyrex cells are supplied with a choice of windows. Please note that all require the Universal 10 cm gas cell mount for use.

Description	Spectrum One/100/400/65	Spectrum Two	Frontier
10cm Short-path Demountable Gas Cells with NaCl Windows	51000634	51000634	51000634
10cm Short-path Demountable Gas Cells with KBr Windows	51000636	51000636	51000636
10cm Short-path Demountable Gas Cells with CaF ₂ Windows	51000638	51000638	51000638
Universal 10cm Gas Cell Mount	51000817	51000817	51000817

DC-2 Diamond Compression Cell

Enables samples to be compressed to an ideal thickness for transmission experiments on an FTIR microscope stage or the Microfocus Beam Condenser. It uses two type IIIa diamond windows, each mounted into a Hastelloy plate. Used in combination with the Microfocus Beam Condenser, a high performance 4x beam condenser. The simple two lens linear optical system ensures easy alignment and high throughput over a wide working wavelength range.

Description	Spectrum One/100/400/65	Spectrum Two	Frontier
Microfocus Beam Condenser with ZnSe Lenses. Requires but does not include DC-2 Diamond Compression Cell	L1272283	L1272354	L1272283
Microfocus Beam Condenser with KRS-5 Lenses. Requires but does not include DC-2 Diamond Compression Cell	L1272284		L1272284
DC-2 Diamond Compression Cell	L1272282	L1272355	L1272355

Variable Temperature Cell

Used for the transmission study of solid or liquid samples at temperatures ranging from -190 °C to 250 °C for solids and -70°C to 250°C for liquids. Holder is supplied with NaCl external windows as standard.

Description	Spectrum One/100/400/65	Spectrum Two	Frontier
Variable Temperature Cell (220V, UK)	L1272288	L1272356	L1272288
Variable Temperature Cell (220V, Eur)	L1272289	L1272357	L1272289
Variable Temperature Cell (110V, 60Hz)	L1272290	L1272358	L1272290

The Tornado™ series of fixed, long pathlength gas cells

Designed for measuring the infrared spectra of gases and vapors at ambient temperatures and pressures. A range of pathlengths is available.

Description	Spectrum One/100/400/65	Spectrum Two	Frontier
Tornado™ T5 Gas Cell 5m FPL; glass body; KBr windows	L1272301	L1272370	L1272301
Tornado™ T10 Gas Cell 10m FPL; glass body; KBr windows	L1272302		L1272302
Tornado™ T20 Gas Cell 20m FPL; glass body; KBr windows	L1272303		L1272303

The Cyclone™ series of fixed and variable long pathlength gas cells

Designed for measuring the infrared spectra of gases and vapors at ambient temperatures and pressures. A range of pathlengths is available.

Description	Spectrum One/100/400/65	Frontier
Cyclone™ C2 gas cell 0.5 to 2.5m; glass body; CaF ₂ windows	L1272470	L1272470
Cyclone™ C2 gas cell 0.5 to 2.5m; metal body; CaF ₂ windows	L1272471	L1272471
Cyclone™ C5 Gas Cell 1-8m VPL; glass body; CaF ₂ windows	L1272299	L1272299
Cyclone™ C5 Gas Cell 1-8m VPL; metal body; CaF ₂ windows	L1272300	L1272300

TRANSMISSION ACCESSORIES

The Storm Short Pathlength (10cm) Gas Cell

Ideal for routine gas and vapor spectroscopic analysis. The cell has a fixed 10 cm pathlength, and is available in Pyrex™ and stainless steel.

Description	Frontier Part No.
Storm Gas cell (Pyrex) with NaCl windows	L1272472
Storm Gas Cell (Pyrex) with KBr windows	L1272473
Storm Gas Cell (stainless steel) with NaCl windows	L1272474
Storm Gas Cell (stainless steel) with KBr windows	L1272475

The Oxford Instrument Optistat DN

A nitrogen reservoir cryostat providing a controlled low temperature exchange gas environment for samples. Designed to operate as an integral part of an optical measurement system.

Description	Frontier Part No.
MIR Optistat DN system (ZnSe windows)	L1272480
NIR Optistat DN system (Sapphire windows)	L1272481
FIR Optistat DN system (Polypropylene windows)	L1272482

The Gasera Photoacoustic PA301 FTIR accessory

For flexible, rapid analysis of solid, semi-solid, and liquid samples in any form without sample preparation. Specially recommended for black samples, in-depth sampling, no-sampling preparation, etc. Photoacoustic principle requires low FT-IR/NIR mirror velocity and PA301 is optimized for 2.5 kHz He-Ne laser modulation frequency (or less).

Description	Frontier Part No.
Photoacoustic PA301 accessory	L1272440

Transmission Options

Description	Part No.	Spectrum One/100/400/65	Spectrum Two	Frontier
Sealed Liquid Cell for Variable Temperature Cell, KBr, 1.00mm pathlength	L1272292	✓	✓	✓
Sealed Liquid Cell for Variable Temperature Cell, KBr, 0.50mm pathlength	L1272293	✓	✓	✓
Sealed Liquid Cell for Variable Temperature Cell, KBr, 0.10mm pathlength	L1272294	✓	✓	✓
Solids Holder for Variable Temperature Cell (Sample size 12 – 30mm diameter and 0.1 – 0.8mm thick)	L1272298	✓	✓	✓
Variable Temperature Cell Holder Jacket KBr windows (pair)	L1272291	✓	✓	✓
Variable Temperature Cell Holder Flow Fittings Kit	L1272359	✓	✓	✓
Cyclone™ C5 Gas Cell Pressure Gauge	L1272307	✓	✓	✓
Cyclone™ C2 Gas Cell Heating Jacket and controller (220V, UK).	L1272364			✓
Cyclone™ C2 Gas Cell Heating Jacket and controller (220V, Europe)	L1272365			✓
Cyclone™ C2 Gas Cell Heating Jacket and controller (110V, 60Hz)	L1272366			✓
Cyclone™ C5 Gas Cell Heating Jacket and controller (220V, UK)	L1272367			✓
Cyclone™ C5 Gas Cell Heating Jacket and controller (220V, Europe)	L1272368			✓
Cyclone™ C5 Gas Cell Heating Jacket and controller (110V, 60Hz)	L1272369			✓
Tornado/Cyclone™ Vacuum/Gas Inlet and Outlet Taps	L1272307			✓



15 Ton Hydraulic Press



13 mm Evacuatable Potassium Bromide Die

15 Ton Hydraulic KBr Press

This bench top easy-to-operate press allows creation of the highest quality KBr pellets. It is used with the Evacuatable KBr die to prepare high quality 13 mm pellets. Requires, but does not include the Evacuatable KBr Die (51001144), the KBr Pellet Holder (04810949), and the Adjustable Adapter (L1060351).

Description	Part No.
15 Ton Hydraulic KBr Press	51004599

Accessories for the 15 Ton Hydraulic KBr Press

Description	Part No.
Evacuatable KBr Die	51001144
Plunger for Evacuatable KBr Die	51001152
Set of upper and lower anvils for Evacuatable KBr Die	04820519
Set of O-rings for Evacuatable KBr Die	04800514
Perspex extractor ring	04977042
KBr Pellet Holder	04810949
Adjustable Adapter to mount KBr Pellet Holder	L1060351

2 Ton Hydraulic KBr Press

This portable KBr press is used to prepare high quality 7 mm KBr pellets. Requires but does not include the 7 mm pellet die and ring holder (L1272492) and 7 mm Disc holder with rectangular mount (L1272493)



Description	Part No.
2 Ton Hydraulic KBr Press	L1272491

2 Ton Hydraulic KBr Press Accessories

Description	Part No.
7 mm Pellet Die including pellet ring holder	L1272492
7 mm Spare Pellet Ring Holder (Qty. 2)	L1272494
7 mm Disc Holder with Rectangular Mount	L1272493

Evacuatable KBr Mini-press

The Mini-press is designed for those situations where you occasionally need to make KBr pellets. This is the simplest solid sample device and is ideal for student use, where very low cost is an important factor. Two highly polished bolts turn against each other in a steel cylinder. The pellet is formed right inside the cylinder which becomes the sample holder. Once formed, the pellet cannot be removed from the cylinder without being destroyed. The Mini-press requires, but does not include, the holder (51002593).

Description	Part No.
Evacuatable KBr Mini-Press	51002592
Holder for Evacuatable KBr Mini-Press	51002593

KBr Pellet Quick Press

The Quick Press provides a fast and economical way to prepare good quality KBr pellets. Pellets with diameters of 1, 3 or 7 mm can be prepared, depending on the die sets used.

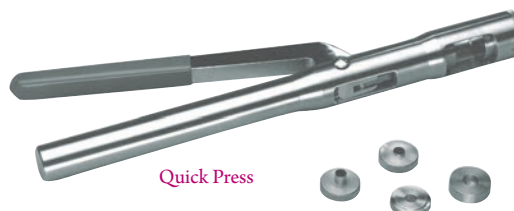

Quick Press

The Quick Press consists of a handpress, a 7 mm die set and a metal collar. Micropellets can be prepared in the Quick Press by purchasing the optional 1 or 3 mm die. The KBr pellet is formed in a metal collar that fits into a Pellet Holder (51002593; required, but not included).

Description	Qty.	Part No.
Quick Press with Die	7 mm	01860436
Optional Die	1 mm	01862295
Optional Die	3 mm	01862292
Spare Die	7 mm	01862289
Pellet Holder for Quick Press		51002593

Support Rings For KBr Pellets

Circular paper rings to reinforce your KBr disks. If the amount of sample is limited there are also paper microframes which reduce the size of the pellet to 11 x 2 mm.

Description	Qty.	Part No.
Paper Rings	100	51001148
Microframes	100	51001149

KBr Powder

Description	Part No.
KBr Powder (100g)	04977043

OilExpress Supplies

Description	Part No.
Insulation Block for Spectrum OilExpress	L1200558
Sample Probe for Spectrum OilExpress	L1200555
OilExpress Flowcell 0.1 mm pathlength, wedged Spacer, ZnSe Windows (one grooved), and two ports.	L1250220
ZnSe Windows for Spectrum OilExpress Flowcell	L1191081
Gaskets and Spacers for Spectrum OilExpress Flowcell	L1191082
Autosampler Oil Bottle Rack, 30-position, 4 oz bottle	L1200551
Autosampler Test Tube Rack, 16 x 6. For 17 x 100 mm tubes	L1200589
10 mL Syringe with Plunger for Spectrum OilExpress	L1200552
Seal Kit for Spectrum OilExpress (4 piston noses)	L1200553
Lubrication Kit for Syringe Pump Screw Drive for Spectrum OilExpress	L1200559
Clamps to prevent Syringe barrel from moving.	L1200574

Tubing

Description	Part No.
Spectrum OilExpress Waste Tubing	L1200560
Sample Needle Tubing for Spectrum OilExpress	L1200587
Flowcell to Syringe Tubing for Spectrum OilExpress	L1200588
Solvent to Syringe Tubing for Spectrum OilExpress (pkg. 2)	L1200556
Injection/Transfer Port to Flowcell Tubing for Spectrum OilExpress	L1200557

Tubes and Bottles

Description	Part No.
17 x 100 mm Polypropylene Tubes (15 ml), Pack of 1200	N0777167
Plug/Cap for 17 mm Tubes, Pack of 1200	N0777599
13 x 100 mm Polypropylene Tubes, Pack of 1000	B0508901
4 oz Clear Plastic Bottle with Lid (Safety Sealed), Case of 600	N9308900
2 oz Clear Plastic Bottle with Lid (Safety Sealed), Case of 800	N9308901

OilExpress 4 Supplies

Consumables

Description	Part No.
17mm Sampling Convenience, Pack of 4800	N9308904
Wide Bore Oil Disposable Tips - pre-loaded 1000µL wide, Pack of 960	L1610022
Wide Bore Oil Disposable Tips, Pack of 4800	L1610023
17mm OD x 100 mm Tall Tubes, Pack of 1200	N0777167
Plug/Cap for 17 mm OD Tubes, Pack of 1200	N0777599
16mm OD x 67 mm Tall Tubes, Pack of 100	L1191079
4 oz. Sample Bottle, Pack of 600	N9308900
2 oz. Sample Bottle, Pack of 600	N9308901
Used Tip Disposable Drip Tray for OilExpress 4 and OilExpress 4 XL	L1610028
Installation Test Oils Kit. Contains 1 x FT-IR In-Service Lubricants Control Oil (N9308350), 1 x OilExpress 4 120cS Test Oil (N9308351) & 1 x OilExpress 4 360cS Test Oil (N9308352)	N9300850
FT-IR In-Service Lubricants Control Oil	N9308350
System Liquid Additive, 100 mL	N9308354
System Liquid Additive, 500 mL	N9308376
System Liquid Detergent Additive, 1 Gallon	N9308380
120cS Test Oil, 500 mL	N9308351
360cS Test Oil, 100 mL	N9308352

Description	Part No.
60 mL Trough, Pack of 25	6008103
60 mL Trough, Pack of 50	6008104

Spare Parts: Autosampler

Description	Part No.
Injection Station Tubing Kit	L1600350
Injection Station	L1610021
Hanging Tip Rack	7607537
VersaTip PLUS RoboRack Kit	7002356
System Liquid Filter Adapter Kit, kit includes - 4 x 40 micron filters (7005398), all necessary fittings and instructions to allow filters to be added to system liquid tubing	7005397
System Liquid Replacement Filter Kit, kit includes - 4 x 40micron filters for system liquid filters. Filters only. Assumes system liquid tubing has already been adapted using System Liquid Filter Adapter Kit (7005397)	7005398
5.0 mL 4-tip Maintenance Kit, kit includes - four (4) syringes, four (4) valves, one (1) tubing replacement kit, and one (1) tube of syringe pump lubrication fluid	7005386
80" x 30" Table, Fixed Height for OilExpress 4 and OilPrep 4, Table accommodates autosampler, FTIR, computer, monitor and keyboard	5085685

Spare Parts: FT-IR Flow Cell

Description	Part No.
ZnSe Flow Cell	L1272490
ZnSe Flow Cell, Refurbished	L1272490R
ZnSe Cell Windows Kit, kit includes pair of ZnSe windows (front and back)	L1272496
Flow Cell Gasket Set	L1272498
Flow Cell Maintenance Kit - includes replacement ZnSe windows (L1272496) and cell gasket kit (L1272498)	L1272495

Spare Parts: FT-IR Instruments

Description	Part No.
Spectrum Two Source Replacement Kit	L1600243
Spectrum Two Desiccant Replacement Kit	L1600244
Spectrum Two ZnSe Window Replacement Kit	L1600242
Spectrum Two KBr Window Replacement Kit	L1600241

Spectrum Two Portability Options

To allow for full portability the Spectrum Two portability pack (contains battery pack, car adaptor, Spectrum Two carry case and wireless router kit) should be ordered. Portability options may also be ordered individually.

Description	Part No.
Spectrum Two Portability Pack – includes UPS Battery Pack, Wireless Router and Spectrum Two Carry Case	L1600238
Battery Pack – portable/UPS (req. country power cord and incl. 12V car adaptor)	L1600233
Spectrum Two Carry Case	L9004199
Spectrum Two UATR Carry Case	L9004200
Spectrum Two Wireless Router Kit	L1600246
12V Car Adaptor	L9004128
Wireless USB Key	L9004198



Disposable Desiccant Kit

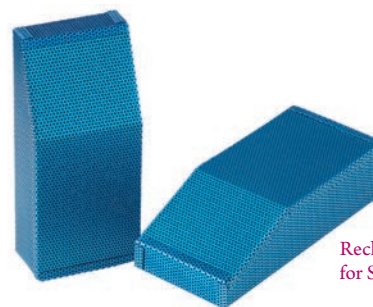

Rechargeable Desiccant Kit for Spectrum One/One NTS

Desiccant Kits

These kits are required for all the PerkinElmer FT-IR Spectrometers to keep the optical path free from moisture. It is recommended that the desiccant is replaced every six months. Follow the instructions in the appropriate instrument manual to install the desiccant.

Disposable Desiccant Kit

User-installable desiccant includes two desiccant packs. Four packs (two kits) required for each desiccant change. Six packs (three kits) required for use with Spectrum 65, Spectrum 100, Spectrum 100N and Spectrum 400.

Description	Part No.
For use with Model 1600, Paragon 500/1000, System 2000, Spectrum One/One NTS/400/1000/2000/BX/GX/RX/65/Frontier	N0171159
For use with Spectrum Two	L1600244

Rechargeable Desiccant Kits

The desiccant is contained in rigid metal cages which are user-installable. Depending on the instrument either one or two cages are required.

Description	Part No.
For Spectrum Spectrum 65/100/100N/400/Frontier Includes: four (4) Desiccant Packs, two to be used in the instrument and two spares for recharging.	L1250311
For Spectrum One/One NTS Includes: four (4) Desiccant Packs, two to be used in the instrument and two spares for recharging.	L1200219
For Spectrum 1000/BX/RX, Model 1600, Paragon 500/1000 Includes: one (1) Desiccant Pack. One pack required for each desiccant change.	L1180480
For Spectrum 400 Second Desiccant area Includes: one (1) Desiccant Pack. One required for each desiccant change.	L1251840

Replacement Laser Head Kit and Sources

Description	Part No.
Laser Head (HeNe) and Laser Power Supply User-installable spare for Spectrum One 65/100/400/Frontier and Spectrum One NTS/100N systems.	L1200253
NIR Source Lamp for Spectrum One/65/100/400/Frontier	L1240098
Mid-IR Source Assembly for Spectrum One/100/400/Frontier	L1200406
Mid-IR Source Element for Spectrum One/65/100/400/Frontier	L1200443
Spectrum Two Source Replacement Kit	L1600243

Instrument Performance Validation (IPV) Kits

Instrument Performance Validation Kits are available for both Mid-IR and Near-IR FT-IR instruments. All the kits include a polystyrene Traceable Reference Material (TRM) for abscissa calibration valid for three years. The Mid-IR IPV kits also include NG 11 Schott Glass Reference Material (RM) for checking the repeatability of ordinate measurement. Upgrade kits are available to replace the polystyrene TRM once the validity period has expired.

Description	Part No.
Mid Infrared IPV kit for Spectrum Software V.6 or lower	L1250404
Mid Infrared IPV upgrade kit for Spectrum Software V.6 or lower	L1250474
Mid Infrared IPV kit for Spectrum 10 Software	L1250404
Mid Infrared IPV upgrade kit for Spectrum 10 Software	L1250474
Near Infrared IPV kit for Spectrum Software V.6 or lower	L1180479
Near Infrared IPV upgrade kit for Spectrum Software V.6 or lower	L1180490
Near Infrared IPV kit for Spectrum 10 Software	L1250425
Near Infrared IPV upgrade kit for Spectrum 10 Software	L1250475
Polystyrene Test Film – 0.038 mm thickness (not traceable)	L1202057
Methane Test Sample for Manual AVI	L1250462
Spectralon Reference Material (for use with Remote Solid Sampling Systems)	L1241446

ATR IMAGING UPGRADE FOR SPOTLIGHT



ATR Imaging Upgrade for Spotlight Systems

Recommended option for the Spotlight 400 or 400N which allows convenient imaging of samples up to 10 mm thick. A large precision aligned crystal enables 400 μm areas to be collected to get more information from the sample quickly.

Description	Qty	Part No.
ATR Imaging Upgrade		L1860319
Spare Germanium Crystal	1	L1860317
ATR Imaging Sample Supports	10	L1860318

Large Area ATR Imaging Accessory

Recommended option for the Spotlight 400 which allows convenient imaging of samples up to ca 8 mm thick. A large precision aligned crystal enables ca 1100 x 1100 micron areas to be collected to get more information from the sample quickly.

Description	Qty	Part No.
Large Area ATR Imaging Accessory		L1860361

Micro ATR Objective Upgrade Kit

This kit upgrades Spotlight 400 and Microscope Systems without ATR Objective to include micro ATR facility. Includes an ATR Objective consisting of a cassegrain, mount and Germanium micro ATR crystal with holder. It covers the range 5,500 – 600 cm^{-1} . A spare Germanium crystal and holder is provided.

Description	Part No.
Micro ATR Objective Upgrade for Spotlight 400 Systems	L1860334
Micro ATR Objective for AutoIMAGE Systems	L1860275
Micro ATR Objective for Multiscope Systems	L1860298
Optional/Spare Silicone Crystal with Holder	L1860269
Spare Germanium Crystal with Holder	L1860268

Hot Stage Accessory

Consists of a heating block, which accepts FT-IR windows and a temperature controller. The Hot Stage can heat samples up to 230 $^{\circ}\text{C}$ in 1 $^{\circ}$ increments. The Hot Stage is held in the slide clip on the sample stage of a PerkinElmer FT-IR Microscope.

Power Requirement	Part No.
Hot Stage 100/120 V, 60 Hz	N1870184
Hot Stage 220/240 V, 50 Hz	N1870188

Microsampling Tools

PerkinElmer offers a range of tools which allow you to prepare and manipulate samples for infrared microspectroscopy.

Description	Part No.
Microsampling Tool Kit	N1870151
Includes:	
Dissecting Forceps	N9302610
Roller Knife	N9302619
Micro Specimen Tweezers	N9302609
Straight Micro Probe	N9302605
Aluminum Probe Handle	N9302622
Pin Vise	N9302603

Microscope Supplies

Description	Part No.
Holder for 13 mm Sampling Disks	L1861634
Holder for 13 mm Sampling Disks Includes gold mirror.	L1860409
Base Microscope Slides Optical quality glass, 1 x 3 in., 1 mm thick for visible observations (box of 72).	N9302600
Low-e Microscope Slides Optical quality with infrared reflective coating, 1 x 3 in., 1 mm thick for visible observations and infrared reflectance measurements (box of 25).	L1272249

Diamond Compression Cell

The cell consists of two Hastelloy plates containing a pair of diamond windows that enable samples to be compressed to an ideal thickness for transmission measurements.

Description	Part No.
Diamond Compression Cell	L1272282

Crystal Compression Cell

This is a device for flattening soft materials and holding specimens flat and in optical contact with salt windows. 1 and 2 mm thick windows of 13 mm outer diameter can be used with the cell. Two KBr windows (2 mm thickness) are included.

Description	Part No.
Crystal Compression Cell	N1870185

Infrared Windows

Infrared windows allow you to support microsamples for infrared analysis with the microscope.

Window Material	Dimensions	Part No.
Barium Fluoride	13 x 1 mm	N9302611
Barium Fluoride	13 x 2 mm	N9302612
Sodium Chloride	13 x 2 mm	N9302614
Potassium Bromide	13 x 2 mm	N9302615

FT-IR Sampling Kits

Two FT-IR Sampling Kits are available to help the newcomer to FT-IR spectroscopy choose the more frequently required items, and to simplify ordering and storage. KBr has been chosen for the transmitting material. The two kits are packaged in attractive storage and carrying cases.



Liquid and Mull FT-IR Sampling Kit

This kit will satisfy the needs of most new users of FT-IR spectroscopy and has been designed to provide all the necessary equipment for handling liquids and mulls. Includes Polystyrene Film (0.038 mm), Nujol™ DD 057(100 mL), 10 cm Micro Spatula, 2mL Luer Syringe, Agate Pestle and Mortar, Magnetic Film Holder-Circular, Universal Demountable Cell Mount, Assorted Spacers, KBr Demountable Cell Windows (two pairs), and KBr Semi-demountable Cell Windows (two pairs).

Description	Part No.
Liquid and Mull FT-IR Sampling Kit	L1365311



General Purpose FT-IR Sampling Kit

This kit includes all of the necessary equipment for handling liquids, mulls and KBr pellets. A laboratory press for making KBr pellets should be ordered. Includes Polystyrene Film (0.038 mm), Universal KBr Disk Holder, Nujol DD 057 (100 mL), 10 cm Micro Spatula, 2 mL Luer Syringe, Agate Pestle and Mortar, Magnetic Film Holder-Circular, KBr Powder (100 g), 13 mm KBr Die, Micro-disk Holder Accessory, Beam Condenser Accessory, 100µm Diameter Sample Holder Accessory, 500 µm Diameter Sample Holder Accessory, Universal Demountable Cell Mount, Assorted Spacers, KBr Demountable Cell Windows (two pairs), and KBr Semi-demountable Cell Windows (two pairs).

Description	Part No.
General Purpose FT-IR Sampling Kit	L1365312

Spectrum Two Educational Starter Pack

A convenient kit which will teach you how to make solid and gas transmission measurements. Includes a simple KBr pellet press and pellet holder as well as a 10 cm gas cell and holder. Potassium Bromide not included.

Description	Part No.
Spectrum Two Educational Starter Kit	L1608022

FT-IR Introductory Kit

This kit contains samples to rapidly familiarize you with sampling techniques such as Transmission, ATR and Diffuse reflectance, and preparing a cast thin film. The kit also provides familiarization with IR software including Basic Operation, Quality Checks and Spectral processing (Search and Compare). The samples included and experiments rapidly demonstrate good sampling technique, sampling accessory selection, managing atmospheric interferences, signal-to-noise ratio, resolution selection and more.

Description	Part No.
FT-IR Introductory Kit (1 User)	L1608001
FT-IR Introductory Kit (5 Users)	L1608002

Solid/Liquid/Gas Sampling Starter Packs

Description	Part No.
KBr Disc Starter Pack Includes Adjustable Adaptor, KBr Die (13 mm) and KBr Pellet Holder.	L1272265
KBr Disc Complete Starter Pack Includes Adjustable Adaptor, KBr Die (13 mm), KBr Pellet Holder, 15 ton press and KBr Powder (100 g).	L1272266
Gas Sampling Starter Pack Includes 10 cm short-pathlength demountable gas cell, Spare KBr windows (47 mm diameter) and Universal gas cell mount.	L1272267
Liquid Sampling Starter Pack Includes Universal Demountable Cell Mount, Circular KBr Windows (pair), Rectangular KBr Windows (pair), 0.1 mm Circular PTFE Spacers (contains 6) and Assorted Rectangular Spacers.	L1272268

FT-IR Sampling Kit Supplies

Description	Size.	Part No.
Nujol	100 mL	04960691
Fluorolube	1 oz bottle	01862301
KBr Powder	100 g	04977043
KBr Random Cuttings	100 g	N9300086
Micro Spatula	10 cm	04967843
Luer Syringe	2 mL	04967845
Agate Pestle and Mortar		04967854

Application packs, described as resource packs or analysis packs depending on whether specific software/calibrations are included, help speed up application development and make your lab more efficient.

FT-IR Educational Resource Pack

For teaching FT-IR Spectroscopy to students and new users. Includes 15 experiments that can be used as part of a training curriculum.

Description	Part No.
FT-IR Educational Resource Pack	L1608003

FT-IR Pharmacopeia Compliance Resource Pack

Designed to assist the user in understanding and achieving compliance to pharmacopeia regulatory requirements in FT-IR analysis, using PerkinElmer Spectrum 10 software and PerkinElmer FT-IR instruments. The pack covers the requirements of seven key Pharmacopoeias (USP, BP, EP, IP, JP, CP and IntPhr).

Description	Part No.
FT-IR Pharmacopeia Compliance Resource Pack	L1608004

FT-IR Nutraceutical Compliance Resource Pack

This pack facilitates IR spectroscopy analysis for Nutraceutical and Traditional Medicine professionals. The pack covers the requirements of seven key Pharmacopoeias (USP, BP, EP, IP, JP, CP and IntPhr). The quality assessment of most of natural products is supported by an included nutraceutical starter set of spectra.

Description	Part No.
FT-IR Nutraceutical Compliance Resource Pack	L1608005

FT-IR Polymer Resource Pack

Designed for use in the rapid screening and identification of polymer materials using FT-IR Spectroscopy. The pack is designed to help in the measurement of good quality spectrum of polymers, identification of polymers, and interpretation of polymer spectra. Utilization of library spectra is illustrated for effective results.

Description	Part No.
FT-IR Polymer Resource Pack	L1608013

Environmental Hydrocarbons ASTM D7066-04 Application Pack

Contains accessories, consumables and application software to perform ASTM D7066-04 (extraction into hydrocarbon-free solvent and then transmission FT-IR). Includes cuvette holder, two Cuvette 10mm and Environmental Hydrocarbons Touch Application Software Kit.

Description	Part No.
Environmental Hydrocarbons ASTM D7066-04 Application Pack	L1608006

Environmental Hydrocarbons Cyclohexane Application Pack

Contains accessories, consumables and application software to perform oil in water measurements by extraction into cyclohexane then transmission FT-IR. Includes two Port Luer Lock %T Cell

- CaF₂ 0.5mm, two 2ml Luer lock Syringe, Spare 0.5mm PTFE Spacer (pk 6), IR Liquid Cell Luer Connected Waste Tube, and Environmental Hydrocarbons Touch Application Software Kit.

Description	Part No.
Environmental Hydrocarbons Cyclohexane Application Pack	L1608007

Environmental Hydrocarbons ATR Application Pack for Spectrum Two

Contains accessories, consumables and application software to perform oil in water measurements by ATR. Includes Spectrum Two HATR, ZnSe 45 deg Top plate – Flat, 25um micro pipette, pipette tips, and Environmental Hydrocarbons Touch Application Software Kit.

Description	Part No.
Environmental Hydrocarbons ATR Application Pack for Spectrum Two	L1608008

In-Service Lubricants Application Pack

Contains accessories, consumables and application software to perform used oil analysis. Includes flow cell with ZnSe windows, wedged spacer and luer fittings for Used Oil Analyzer, 3ml luer lock plastic syringe Starter Pk 100, Torque screwdriver, HEX BIT 3.0mm, IR Liquid Cell Luer Connected Waste Tube, PTFE plugs (pk 6) plugs, and In-Service Lubricants Touch Application Software Kit.

Description	Part No.
In-Service Lubricants Application Pack	L1608009

IR Biodiesel Application Pack

Contains accessories, consumables and application software to perform Biodiesel analysis using IR. Includes 2 Port Luer Lock %T Cell - BaF₂ 0.1mm, 2 x 2ml Luer lock Syringe, Assorted PTFE Spacers, Torque screwdriver, HEX BIT 3.0mm, IR Liquid Cell Luer Connected Waste Tube, and Fuels FT-IR Touch Application Software Kit. Does not support ASTM D7371.

Description	Part No.
IR Biodiesel Application Pack	L1608010

IR Benzene in Gasoline ASTM D4053-04 Application Pack

Contains accessories, consumables and application software to measure Benzene in Gasoline by IR. Includes 2 Port Luer Lock %T Cell - KBr 0.05mm, 2 x 2ml Luer lock Syringe, Spare 0.05mm PTFE Spacer (pk 6), Torque screwdriver, HEX BIT 3.0mm, IR Liquid Cell Luer Connected Waste Tube, AVI Manual Kit, FT-IR Fuels Touch Application Software Kit.

Description	Part No.
IR Benzene in Gasoline ASTM D4053 – 04 Application Pack	L1608012

Transfat Application Pack

Description	Part No.
Trans-Fat Application Pack	L1608015

ENSURING SAFETY AND AUTHENTICITY WITH EVERY SAMPLE



PerkinElmer's consumables and accessories for DairyGuard™ are designed to keep your system running at peak performance while screening for potential economic adulterants in milk powder. In addition, these accessories are ideal when the application is extended to monitor for protein, moisture and fat levels.

Consumables

Description	Part No.
90 mm Plastic Petri Dishes suitable for NIRA II 100 mm spinner, Pack of 600	L9004575
55 mm Plastic Petri Dishes suitable for NIRA II 60 mm spinner, Pack of 1620	L9004578
60 mm Soda Glass Petri Dishes suitable for NIRA II 60mm spinner, Pack of 10	L9004574
100 mm Soda Glass Petri Dishes suitable for NIRA II 100mm spinner, Pack of 10	L9004573
19 mm Glass Vials, 19 mm x 51 mm, Pack of 144	L9004892

Spare Parts and Miscellaneous

Description	Part No.
Spare NIR source , monkey NIR Frontier and Dual MIR / NIR Frontier	L1242701
Desiccant pack - Frontier, Spectrum 100 , Spectrum 400	L0171159
Barcode Reader, hand- held	L9004196
Transflectance ICRA Liquids Sampler Kit - includes five Petri Dish Liquid Reflectors and bases, NIRA Liquids Sampling procedure and user guide	L1185153

Reflectance Standards

PerkinElmer offers a variety of Reflectance Standards to help ensure the system is running optimally for milk powder analysis. Choose from various combinations of calibrated or uncalibrated reflectance that deliver optimum screening results.

Description	Part No.
99% Reflectance Polymer 60 mm, 8 mm x 58 mm, Uncalibrated	L1281920
99% Reflectance Polymer 100 mm, 8 mm x 98 mm, Uncalibrated	L1281921
99% Reflectance Standard 60 mm, 8 mm x 58 mm, Calibrated	L1281922
99% Reflectance Standard 100 mm, 8 mm x 98 mm, Calibrated	L1281923
50% Reflectance Standard 60 mm, 8 mm x 58 mm, Calibrated	L1281924
50% Reflectance Standard 100 mm, 8 mm x 98 mm, Calibrated	L1281925
Reflectance Standards, 60 mm, 8 mm x 58 mm, Calibrated, set of 4	L1281926
Reflectance Standards, 100 mm, 8 mm x 98 mm, Calibrated, set of 4	L1281927
Reflectance Abscissa Standard 60mm, 8 mm x 58 mm, Calibrated	L1281928
Reflectance Abscissa Standard 100mm, 8 mm x 98 mm, Calibrated	L1281929
Reflectance Standard Recalibration Service, it is recommended that reflectance standards are re-calibrated after 12 months	L1281930

Sample Cups

Sample cups for DairyGuard™ system are 50 mm, black, round, metal with quartz glass base. These versatile cups can also be used to analyze dry, ground food or agriculture products. All cups use the same disposable backs for convenience.

Description	Part No.
50 mm with Quartz Base	L1281931
50 mm with Quartz Base, Screw Back	L1281932
50 mm Camlock Cup with Quartz Powder Base	L1281933
50 mm with Disposable Backs	L1281934

DEUTERIUM AND TUNGSTEN SOURCE LAMPS

PerkinElmer's long-lifetime deuterium and tungsten source lamps provide the best wavelength coverage across the working range of the spectrometer for consistently high performance. All lamps are pre-aligned and can be easily changed by the user. Our extensive quality control and inspection process demands the very best quality sources to provide high sensitivity and stability for your key measurements.



Deuterium Lamp
Part No. L6022728

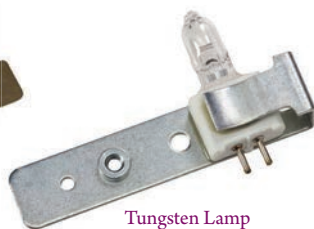

Tungsten Lamp
Part No. B0114620



Source Lamps for LAMBDA Spectrophotometers

Deuterium Lamps

LAMBDA Model	Part No.
For LAMBDA 2X/3X/4X/6XX/7XX/8XX/9XX/10XX*	L6022728

Tungsten Lamps

LAMBDA Model	Part No.
For LAMBDA 2X/3X/4X/6XX/7XX/8XX/9XX/10XX*	B0114620

*Prefocused and prealigned.

Calibration Reference Materials for PerkinElmer and non-PerkinElmer Spectrometers

PerkinElmer reference materials speed calibration verification of UV/Vis and UV/Vis/NIR spectrometers*, providing laboratory managers with the evidence they need to pass the strictest quality audit.



Photometric and Wavelength Accuracy Reference Material Set

A comprehensive range of certified traceable filters and sealed cuvettes fit into the standard 10mm cuvette holder of PerkinElmer and non-PerkinElmer instruments allowing users to generate simple protocols to verify ordinate and abscissa accuracy, stray light radiation, and spectral resolution. All reference materials are certified traceable to NIST primary reference materials and are supplied with a calibration certificate detailing the calibration method and results.

A central PerkinElmer recertification laboratory equipped with state-of-the-art instrument technology ensures a rapid turnaround service for periodic recalibration of PerkinElmer and non-PerkinElmer reference materials, allowing laboratories to maintain the requirements of their calibration SOP's.

Features and Benefits

- Comprehensive range of reference materials
- Traceable to NIST
- Immediate availability
- Rapid recertification service for PerkinElmer and non-PerkinElmer reference materials

*Not diode array spectrometers.

CALIBRATION AND RECERTIFICATION SOLUTIONS

Photometric and Wavelength Accuracy Reference Material Set

Description	Part No.
Photometric and Wavelength Accuracy Reference Material Set	B0507805

A set of reference materials used to verify the ordinate and abscissa (wavelength) accuracy of UV/Vis and UV/Vis/NIR Spectrometers. Neutral density glass filters included in this kit are ALZA ISO 17025 accredited.



The set includes four glass filters mounted in precision aluminum spring mounts. The cells are designed for use with standard 10 mm cuvette holders of most UV/Vis and UV/Vis/NIR Spectrometers. There are three neutral density glass filters for checking the ordinate accuracy and a holmium oxide glass filter for checking the wavelength accuracy of a spectrometer. Each filter has an identification number. The ordinate and abscissa values of each filter are quoted in the accompanying Certificate of Calibration, nominally 1A (10%T), 0.5A (30%T) and 0.3A (50%T). Reference materials are supplied in a re-useable UV-protective storage container.*

Stray Light Solutions Reference Material Set

Description	Part No.
Stray Light Solutions Reference Material Set	B2500099

Set of reference materials comprising four solutions in sealed cells — one reference solution and three test solutions. The cells are designed for use with standard 10 mm cuvette holders of most UV/Vis and UV/Vis/NIR Spectrometers. The test solutions, comprising sodium iodide, sodium nitride, and potassium chloride, act as a cut-off filter with a very precise wavelength. Reference materials are accompanied with a Certificate of calibration and are supplied in a re-useable UV-protective storage container.*

Pharmacopoeia Solutions Reference Material Set

Description	Part No.
Pharmacopoeia Solutions Reference Material Set	B2500100

* Since UV/Vis and UV/Vis/NIR reference materials require periodic recertification a rapid, convenient recertification program is available through PerkinElmer's central recertification laboratory.

Reference materials to verify calibration of UV/Vis and UV/Vis/NIR Spectrometers in accordance with Pharmacopoeia monographs, including:

- Ordinate (photometric) accuracy (potassium dichromate in perchloric acid)
- Abscissa (wavelength) accuracy (holmium perchlorate)
- Stray radiation level (potassium chloride)
- Resolution (toluene in hexane)

Set of reference materials comprising six solutions in sealed cells — two reference solutions and four test solutions. The cells are designed for use with standard 10mm cuvette holders of most UV/Vis and UV/Vis/NIR Spectrometers. Reference materials are accompanied with a Certificate of calibration and are supplied in a re-useable UV-protective storage container.

Reference Mirror for Reflectance Spectroscopy

Description	Part No.
Reference Mirror for Reflectance Spectroscopy	N1010504

This mirror is required to verify the specular reflectance calibration of PerkinElmer and Non-PerkinElmer reflectance accessories. The aluminum mirror with magnesium fluoride coating is a secondary standard and is calibrated according to GLP regulations in the wavelength range 250 to 2500 nm and includes spectral data on convenient transfer media for %RC reflection correction.

Recertification Program for UV/Vis Calibration Reference Materials

Description	Part No.
Recertification Program for UV/Vis Calibration Reference Materials	N1010539

To guarantee the integrity of your Reference Material set they must be recertified at periodic intervals. PerkinElmer offers a rapid service through our convenient central recertification laboratory in the USA. The recertification process includes as received analysis, inspection and cleaning of the reference material, recertification testing using state-of-the-art instrument technology, and certificate of the results. Fast shipment to and from our laboratory from anywhere in the world is free and we return your recertified standards in ten business days or less from the time we receive them.

Note: A recertification service for individual reference materials or non-PerkinElmer reference materials is also available. Please contact our recertification laboratory in the United States by phone (1-203-402-6852) or email (PKIFILTERS@PerkinElmer.com) for availability, pricing, requests, ordering procedures and other questions.

Diffuse Reflectance Standards

Description	Part No.
99% Diffuse Reflectance Standard, 2-inch, calibrated	PELA 9058
2%, 50%, 75%, 99% Diffuse Reflectance Standards Kit, 2-inch, calibrated	PELA 9011
2%, 5%, 10%, 20%, 40%, 60%, 80%, 99% Diffuse Reflectance Standards Kit, 2-inch, calibrated	PELA 9013
Diffuse Reflectance Standards Kit, 2-inch, calibrated color: R, G, B and Y	PELA 9018
Diffuse Reflectance Standards Kit, 2-inch, calibrated color: O, P, C, and V	PELA 9019
Adjustable Prop	L6020329

HIGHEST QUALITY FOR EVERY APPLICATION

PerkinElmer Cells Ensure Top Optical Performance, with High Cell Transmission and Accurate Pathlength



No matter what type of cells your application requires — rectangular or cylindrical, standard or short path, micro, semi-micro or flowcells — choosing only high quality, precision cells allows you to make full use of the accuracy and sensitivity of your optical instrument.

The cell windows are fused to the bodies by a special process which avoids deformation of the windows. This assures that the full width of the cell is usable and the finished cell dimensions are maintained.

Our cells are manufactured from various types of glass. We offer three basic materials: Special Optical Glass, SUPRASIL® UV Quartz and SUPRASIL 300 NIR Quartz, in all the common sizes and types. The most important criterion for the choice of a particular type of glass is the spectral range for which the cell is intended. Color logos are fused onto each PerkinElmer cell, thus indicating the spectral range over which the cell can be used.

Special Optical Glass 320 nm - 2,500 nm

Indicates that SCHOTT type UK 5 is used for cells referred to in the catalog as manufactured from “Special Optical Glass”. This crown glass is made from exceptionally pure raw materials, which gives an improved transmission in the near ultraviolet range. An empty cell will give a transmission of more than 80% over a spectral range of between 320 nm and 2,500 nm.

SUPRASIL UV Quartz 200 nm - 2,500 nm

Indicates that quartz of the highest purity and homogeneity has been used for the window. Because it is produced from a silicon compound, it is also called synthetic quartz. SUPRASIL gives transmission values of more than 80% over a spectral range of between 200 nm and 2,500 nm for an empty cell.

SUPRASIL 300 NIR Quartz 200 nm - 3,500 nm

Denotes a synthetic quartz that is free from OH absorption. Therefore it is suitable for applications in the near infrared range up to approximately 4,000 nm. SUPRASIL 300 gives a transmission of more than 80% over a spectral range of between 200 nm and 3,500 nm for an empty cell.

Macro Cells

Standard rectangular macro cells are the most frequently-used type of spectroscopy cell for routine liquids analysis. Each cell has a standard inside width of 9.5 mm and a base thickness of 1.5 mm.

Macro with PTFE Lid

Lightpath	Outside Dim. H x W x D	Cell Volume	Qty.	Part No.
NIR Quartz SUPRASIL® 300				
1 mm*	45 x 12.5 x 3.5 mm	350 µL	2	B0631013
5 mm	45 x 12.5 x 7.5 mm	1.75 mL	2	B0631014
10 mm	45 x 12.5 x 12.5 mm	3.5 mL	2	B0631015
20 mm	45 x 12.5 x 22.5 mm	7.0 mL	2	B0631016
50 mm	45 x 12.5 x 52.5 mm	17.5 mL	1	B0631017
100 mm	45 x 12.5 x 102.5 mm	35.0 mL	1	B0631018
Optical Glass 360-2,500 nm without lid				
10 mm	45 x 12.5 x 12.5 mm	3.5 mL	4	B0631134
Quartz SUPRASIL				
1 mm*	45 x 12.5 x 3.5 mm	350 µL	2	B0631007
5 mm	45 x 12.5 x 7.5 mm	1.75 mL	2	B0631008
10 mm	45 x 12.5 x 12.5 mm	3.5 mL	2	B0631009
20 mm	45 x 12.5 x 22.5 mm	7.0 mL	2	B0631010
50 mm	45 x 12.5 x 52.5 mm	17.5 mL	1	B0631011
100 mm	45 x 12.5 x 102.5 mm	35.0 mL	1	B0631012
Special Optical Glass				
1 mm*	45 x 12.5 x 3.5 mm	350 µL	2	B0631001
5 mm	45 x 12.5 x 7.5 mm	1.75 mL	2	B0631002
10 mm	45 x 12.5 x 12.5 mm	3.5 mL	2	B0631003
20 mm	45 x 12.5 x 22.5 mm	7.0 mL	2	B0631004
50 mm	45 x 12.5 x 52.5 mm	17.5 mL	1	B0631005
100 mm	45 x 12.5 x 102.5 mm	35.0 mL	1	B0631006

*Glass lid.

Macro with PTFE Stopper

Lightpath	Outside Dim. H x W x D	Cell Volume	Qty.	Part No.
NIR Quartz SUPRASIL 300				
1 mm	52 x 12.5 x 3.5 mm	350 µL	2	B0631031
5 mm	46 x 12.5 x 7.5 mm	1.75 mL	2	B0631032
10 mm	46 x 12.5 x 12.5 mm	3.5 mL	2	B0631033
20 mm	46 x 12.5 x 22.5 mm	7.0 mL	2	B0631034
50 mm	46 x 12.5 x 52.5 mm	17.5 mL	1	B0631035
100 mm	46 x 12.5 x 102.5 mm	35.0 mL	1	B0631036
Quartz SUPRASIL				
1 mm	52 x 12.5 x 3.5 mm	350 µL	2	B0631025
5 mm	46 x 12.5 x 7.5 mm	1.75 mL	2	B0631026
10 mm	46 x 12.5 x 12.5 mm	3.5 mL	2	B0631027
20 mm	46 x 12.5 x 22.5 mm	7.0 mL	2	B0631028
50 mm	46 x 12.5 x 52.5 mm	17.5 mL	1	B0631029
100 mm	46 x 12.5 x 102.5 mm	35.0 mL	1	B0631030
Special Optical Glass				
1 mm	48 x 12.5 x 3.5 mm	350 µL	2	B0631019
5 mm	46 x 12.5 x 7.5 mm	1.75 mL	2	B0631020
10 mm	46 x 12.5 x 12.5 mm	3.5 mL	2	B0631021
50 mm	46 x 12.5 x 52.5 mm	17.5 mL	1	B0631023

Semi-micro Cells

Semi-micro cells have the same outside dimension as the Macro cells but the cell walls have been thickened slightly, limiting the interior sample chamber width to 4 mm. Each cell has a base thickness of 3.2 mm and each package contains two cells.



Semi-micro with PTFE Lid – Black Sides

Lightpath	Outside Dim. H x W x D	Cell Volume	Part No.
NIR Quartz SUPRASIL 300			
10 mm	45 x 12.5 x 12.5 mm	1.4 mL	B0631051
Quartz SUPRASIL			
5 mm	45 x 12.5 x 7.5 mm	700 µL	B0631048
10 mm	45 x 12.5 x 12.5 mm	1.4 mL	B0631049
Special Optical Glass			
5 mm	45 x 12.5 x 7.5 mm	700 µL	B0631046
10 mm	45 x 12.5 x 12.5 mm	1.4 mL	B0631047

Semi-micro with PTFE Lid – Clear Sides

Lightpath	Outside Dim. H x W x D	Cell Volume	Part No.
NIR Quartz SUPRASIL 300			
20 mm	45 x 12.5 x 22.5 mm	2.8 mL	B0631045
Quartz SUPRASIL			
20 mm	45 x 12.5 x 22.5 mm	2.8 mL	B0631042
Special Optical Glass			
20 mm	45 x 12.5 x 22.5 mm	2.8 mL	B0631039

Semi-micro with PTFE Stopper – Black Sides

Lightpath	Outside Dim. H x W x D	Cell Volume	Part No.
NIR Quartz SUPRASIL® 300			
5 mm	46 x 12.5 x 7.5 mm	700 µL	B0631065
10 mm	46 x 12.5 x 12.5 mm	1.4 mL	B0631066
Quartz SUPRASIL			
10 mm	46 x 12.5 x 12.5 mm	1.4 mL	B0631064

Semi-micro with PTFE Stopper – Clear Sides

Lightpath	Outside Dim. H x W x D	Cell Volume	Part No.
NIR Quartz SUPRASIL 300			
20 mm	46 x 12.5 x 22.5 mm	2.8 mL	B0631060
Quartz SUPRASIL			
20 mm	46 x 12.5 x 22.5 mm	2.8 mL	B0631057

Micro Cells

Micro cells have the same outside dimension as the Macro cells but the cell walls have been thickened, limiting the interior sample chamber width to 2 mm. Each cell has a standard light path of 10 mm and each package contains two cells.



Micro with PTFE Lid - Black Sides

Outside Dim. H x W x Dt	Base Thickness	Cell Volume	Part No.
Quartz SUPRASIL®			
45 x 12.5 x 12.5 mm	3.2 mm	700 µL	B0631071
Special Optical Glass			
45 x 12.5 x 12.5 mm	3.2 mm	700 µL	B0631070

Micro with PTFE Stopper - Black Sides

Outside Dim. H x W x Dt	Base Thickness	Cell Volume	Part No.
Quartz SUPRASIL			
40 x 12.5 x 12.5 mm	1.5 mm	400 µL	B0631077
Special Optical Glass			
40 x 12.5 x 12.5 mm	1.5 mm	400 µL	B0631076

Ultra-micro Cells

Ultra-micro cells use a narrower sample chamber, raising it directly into the center of the light path and masking it with black quartz. One cell with light path 40 x 12.5 x 12.5 mm.

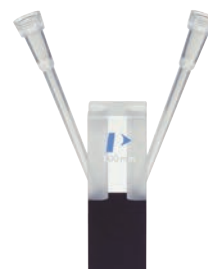

Ultra-micro with PTFE Lid

Lightpath	Aperture	Chamber Volume	Part No.
Quartz SUPRASIL			
10 mm	2 x 1.5 mm	30 µL	B0631079

Ultra-micro with Pipette Tips

Lightpath	Aperture	Chamber Volume	Part No.
Quartz SUPRASIL			
0.1 mm	1 x 5 mm	0.5 µL	B0631082
1 mm	1 x 5 mm	5 µL	B0631083
5 mm	∅ 0.8 mm	2.5 µL	B0631080
10 mm	∅ 0.8 mm	5 µL	B0631081

TrayCell™

The TrayCell is a fiber-optic ultra-micro measuring cell designed for the UV/Vis analysis of DNA/RNA and proteins. The dimensions of the TrayCell are equivalent to a standard cuvette in order to work in most spectrophotometers.



Features and Benefits

- Suitable for almost any current spectrophotometers
- Ideally suited for very small measurement volumes: 0.7 μL to 10 μL
- Trouble-free measurement of the sample at different optical path lengths simply by exchanging the cap [caps with dilution factors: 5, 10, 50 and 100]
- Fast and simple cleaning of the optics before measuring the next sample - the TrayCell remains in the cell holder!
- Samples can be reused after the measurement simply by pipetting them off
- During measurements, TrayCell shows excellent reproducibility

TrayCell™

Description	Part No.
UVS TrayCell complete with 0.2 mm and 1.0 mm caps. Complete with blocks to change beam height from 8.5 mm to 15 mm to 20 mm	L7110289
2.0 mm TrayCell, (Factor* 5) cap	L7110290
1.0 mm TrayCell, (Factor* 10) cap	L7110291
0.2 mm TrayCell, (Factor* 50) cap	L7110292
2 mm TrayCell, (Factor* 100) cap	L7110293

Caps for TrayCell™

Description	Volume	Part No.
1 mm (Factor* 10)	3 μL - 5 μL	L7110291
0.2 mm (Factor* 50)	0.7 μL - 4 μL	L7110292
2 mm (Factor* 5)	6 μL - 10 μL	L7110290
0.1 mm (Factor* 100)	0.7 μL - 3 μL	L7110293

* Factor = dilution factor compared to a standard cell with a path length of 10 mm

Cylindrical Cells – Macro with PTFE Stopper

Cylindrical cells are used with spectrophotometers that have a larger, circular light beam. Each cell has an outside diameter of 22 mm and an inside diameter of 19 mm. Each package contains one cell and two windows.

Material	Lightpath	Outside Depth	Cell Volume	Remarks	Part No.
NIR Quartz SUPRASIL® 300					
	10 mm	12.5 mm	2.8 mL	Neck Ø 6 mm Taper 1:10	B0631099
	20 mm	22.5 mm	5.6 mL	Neck NS 7	B0631100
	50 mm	52.5 mm	14.0 mL	2 necks NS 7	B0631101
	100 mm	102.5 mm	28.0 mL	2 necks NS 7	B0631102
Quartz SUPRASIL					
	10 mm	12.5 mm	2.8 mL	Neck Ø 6 mm Taper 1:10	B0631095
	20 mm	22.5 mm	5.6 mL	Neck NS 7	B0631096
	50 mm	52.5 mm	14.0 mL	2 necks NS 7	B0631097
	100 mm	102.5 mm	28.0 mL	2 necks NS 7	B0631098
Special Optical Glass					
	10 mm	12.5 mm	2.8 mL	Neck Ø 6 mm Taper 1:10	B0631091
	20 mm	22.5 mm	5.6 mL	Neck NS 7	B0631092
	50 mm	52.5 mm	14.0 mL	2 necks NS 7	B0631093
	100 mm	102.5 mm	28.0 mL	2 necks NS 7	B0631094



NIR Quartz SUPRASIL Cylindrical Cells Macro with PTFE Stopper, 10 mm **Part No. B0631099**

Flow-through Cells

Flow-through cells are used for measuring samples with continuous flow or with Sippers where individual samples are aspirated into the cell. All cells have center heights of 15 mm. Each package contains one cell with two clear windows. The cells listed below are Compact with two screw connectors, M6 x1 and 500 mm length FEP tubing - 1.9 mm o.d., 1.1 mm i.d.

Material	Lightpath	Centre Height	Outside Depth	Aperture	Cell Volume	Part No.
Quartz SUPRASIL	1 mm	15 mm	35 x 12.5 x 12.5 mm	17.5 x 3.5 mm	62 µL	B0631085
Quartz SUPRASIL	10 mm	15 mm	35 x 12.5 x 12.5 mm	11 x 3.5 mm	390 µL	B0631084
Quartz SUPRASIL	10 mm	15 mm	35 x 12.5 x 12.5 mm	8 x 2 mm	160 µL	B0631087
Quartz SUPRASIL	10 mm	15 mm	35 x 12.5 x 12.5 mm	11 x 2.5 mm	300 µL	B0631150
Quartz SUPRASIL	10 mm	15 mm	35 x 12.5 x 12.5 mm	Ø 3 mm	80 µL	B0631089
Quartz SUPRASIL	50 mm	15 mm	45 x 12.5 x 52.5 mm	Ø 3 mm	370 µL	B0631088
Quartz SUPRASIL	10 mm	15 mm	35 x 12.5 x 12.5 mm	Ø 2 mm	30 µL	B0631090
Quartz SUPRASIL (FIAS)	10 mm	15 mm	35 x 12.5 x 12.5 mm	Ø 1.5 mm	18 µL	B0631151
Quartz SUPRASIL (FIAS)	10 mm	15 mm	35 x 12.5 x 12.5 mm	Ø 1 mm	8 µL	B0631152

Lids and Stoppers

Description	Lightpath	Part No.
PTFE Fitted Lid	5 mm	B0631145
PTFE Fitted Lid	10 mm	B0631129
PTFE Stopper with NS 7 Fitting		B0631128
PTFE Stopper with Fitting Ø 6, taper 1:10		B0631149

Replacement Tubing

Description	Part No.
FEP-Replacement Tubing with one short screw fitting, 500 mm long	B0631130
FEP-Replacement Tubing with one long screw fitting, 500 mm long	B0631131
Sipper Tubing to Cuvette (in)	B2500129
Sipper Tubing to Cuvette (out)	B2500127

DISPOSABLE CELLS



Disposable cells greatly reduce the risk of contamination, remove the need for cleaning reagents and lower laboratory costs as compared to quartz or glass cells.

Disposable cells are available in polystyrene and polymethyl methacrylate either as macro or semi-micro cells. Additionally, disposable cells are available in a special UV transparent material in macro, semi-micro and micro cells. The useful spectral range for UV material is between 220 and 900 nm, for polymethyl methacrylate it is 300 and 900 nm and for polystyrene it is 340 and 900 nm.

Each cell has a standard light path of 10 mm and is suitable for any UV/Vis Spectrophotometer which accommodates cells with a center height of 15 mm.

Color coded caps can be ordered for the micro UV transparent cells which allow samples to be stored down to -20 °C.

Macro Cells

Description	Outside Dimensions	Cell Volume	Qty.	Part No.
UV Material	45 x 12.5 x 12.5 mm	2.5 – 4.5 mL	100	L7110269
Polystyrene	45 x 12.5 x 12.5 mm	2.5 – 4.5 mL	1,000	L7110271
Polymethyl Methacrylate	45 x 12.5 x 12.5 mm	2.5 – 4.5 mL	1,000	L7110273



Micro Cells

Description	Outside Dimensions	Cell Volume	Qty.	Part No.
UV Material	45 x 12.5 x 12.5 mm	70 – 550 µL	100	L7110260
UV Material	45 x 12.5 x 12.5 mm	70 – 550 µL	500	L7110261
UV Material Individually Wrapped*	45 x 12.5 x 12.5 mm	70 – 550 µL	100	L7110262
Caps - Blue			100	L7110264
Caps - Yellow			100	L7110265
Caps - Green			100	L7110266
Caps - Orange			100	L7110267

* Free of DNase, DNA and RNase



Semi-micro Cells

Description	Outside Dimensions	Cell Volume	Qty.	Part No.
UV Material	45 x 12.5 x 12.5 mm	1.5 – 3.0 mL	100	L7110268
Polystyrene	45 x 12.5 x 12.5 mm	1.5 – 3.0 mL	1,000	L7110272
Polymethyl Methacrylate	45 x 12.5 x 12.5 mm	1.5 – 3.0 mL	1,000	L7110274

Cell Rack

Also available is a cell rack for easy storage of samples. It is suitable for standard 10 mm light path cells and holds up to 16 cells in numbered positions to aid sample tracking. The cell rack can withstand temperatures up to 121 °C so it can be used in an Autoclave.

Description	Qty.	Part No.
Cell Rack, 16 cell capacity	1	L7110275

To extend the range of samples that you can analyze, we offer a wide range of sample holders.

The rectangular and cylindrical long-path cell holders are ideal for sensitive measurements on dilute samples where the extra pathlength is important. For the chemist, the test-tube holder provides a convenient method of sampling in-situ without having to decant the sample into standard cells.

Finally, extend your measurement capabilities to include solid materials with the solid and variable-angle sample holders.

Solid Sample Holder

Minimum sample size 10 x 15 mm. Maximum sample thickness 5 mm.

Description	Part No.
Solid Sample Holder	B0080822

Test Tube Holder

This holder accommodates test tubes from 11 to 17 mm diameter.

Description	Part No.
Test Tube Holder	B0500952

Variable Angle Sample Holder

0° to 60° for sample position for measurement in transmission of filter glasses and other transparent samples. Minimum sample size is 30 x 40 mm.

Description	Part No.
Variable Angle Sample Holder	B0152471



Test Tube Holder

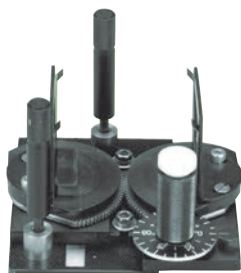

Variable Angle Sample Holder

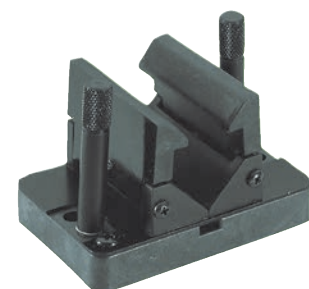

Cylindrical Long-path Cell Holder



Solid Sample Holder

MAXIMIZE SAMPLING FLEXIBILITY

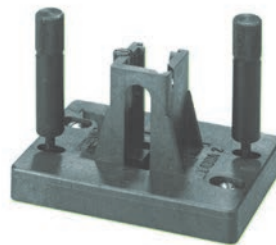

Standard Cell Holder

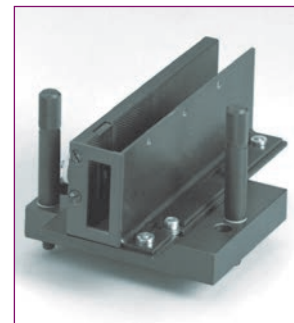

Rectangular Long-path Cell Holder

Standard Cell Holder

The Standard Cell Holder is provided as standard equipment with your PerkinElmer LAMBDA Series instrument. A lifter (included) makes short cell removal easy. It accommodates a large selection of rectangular cells up to 10 mm pathlength. The Standard Cell Holder is adjustable both vertically and horizontally.

Description	Part No.
Standard Cell Holder	B0505071

Rectangular Long-path Cell Holder

The Rectangular Long-path Cell Holder accepts cells with pathlengths from 10 to 100 mm. This optional cell holder is easy to install and has the same footprint as the Standard Cell Holder. It is designed for a precise fit and gives you maximum reproducibility.

Description	Part No.
For LAMBDA 1X/2X/3X/4X/6XX/8XX/9XX/10XX/Bio	B0080821

Cylindrical Long-path Cell Holder

The Cylindrical Long-path Cell Holder accommodates cells with outside diameters from 22 to 30 mm. A versatile cell holder, it accepts cells with pathlengths up to 100 mm. The spring loaded clamping arms provide a precise, reproducible fit and are easy to adjust.

Description	Part No.
Cylindrical Long-path Cell Holder	C0550303

5+5 Cell Changer for LAMBDA 1X/2X/3X/4X/Bio

Automatic linear 5+5 cell changer for long pathlength cells up to 50 mm. Includes: Automatic Linear Transport (B2000186), Reference Kit (B2000310), and two Long Pathlength 5-Cell Holders (B0089439). No accessory PCB required.

Description	Part No.
5+5 Cell Changer for LAMBDA 1X/2X/3X/4X/Bio	N1010569

8+1 Cell Changer for LAMBDA 1X/2X/3X/4X/Bio

Automatic water thermostatable linear cell changer for eight samples and one reference. Includes: Automatic Linear Transport (B2000186), 8-Cell Holder Water Thermostatable (B2205411), and Water Thermostatable Reference Cell Holder (B2000201). No accessory PCB required.

Description	Part No.
8+1 Cell Changer for LAMBDA 1X/2X/3X/4X/Bio	N1010567

8+8 Cell Changer for LAMBDA 1X/2X/3X/4X/Bio

Automatic water thermostatable linear cell changer for eight samples and eight references. Includes: Automatic Linear Transport (B2000186), Reference Kit (B2000310), and two 8-Cell Holders (B2205411). No accessory PCB required.

Description	Part No.
8+8 Cell Changer for LAMBDA 1X/2X/3X/4X/Bio	N1010568

13-Cell Changer System for LAMBDA 1X/2X/3X/4X/Bio

Includes cell changer and one carousel each for glass/quartz and plastic cuvettes. Accessory PCB (L6000500) required for LAMBDA 25/35/45, or PCB (B0509681) required for LAMBDA 10/20/40/Bio, but not included.

Description	Part No.
13-Cell Changer System for LAMBDA 1X/2X/3X/4X/Bio	B0185210



8+1 Cell Changer Configuration

Automatic Linear Transport for LAMBDA 1X/2X/3X/4X/Bio

Automatic linear transport unit. Can be combined with 8-Cell Holder, Water Thermostatable (B2205411), Long Pathlength 5-Cell Holders (B0089439), or Research Peltier System (L6310011). For reference position, Reference Kit (B2000310) and 5- or 8-Cell Holder recommended, but not included. Water Thermostatable Reference Cell Holder (B2000201) can be used alternatively.

Description	Part No.
Automatic Linear Transport for LAMBDA 1X/2X/3X/4X/Bio	B2000186

Reference Kit

For Automatic Linear Transport (B2000186). For reference position to be used with 8-Cell Holder, Water Thermostatable (B2205411) or Long Pathlength 5-Cell Holder (B0089439).

Description	Part No.
Reference Kit	B2000310

Gel Cell, Glass

For gel measurements with Gel-Scanner Linear Transport (B2000199). Dimensions are 6 mm pathlength by 100 mm width by 10 mm height.

Description	Part No.
Gel Cell, Glass	CP183700

FAST, EFFICIENT, TEMPERATURE-CONTROL



9 Cell w/ Reference Cell

Routine Peltier Systems

Routine Peltier System – Single Sample Accessory + Single Reference Accessory

Includes the Peltier Single Sample Accessory (B2000159) for the sample position and the Single Reference Accessory (B0510412) for the reference position. Also included are a reference position cover, power supply, power cables, and User's Guide. Selectable temperature range 20 °C to 45 °C. Requires the LAMBDA 25, 35, 45 Accessory Board (L6000500).

LAMBDA Model	Part No.
1X/2X/3X/4X/Bio	N1010565

Routine Peltier System – 9-Sample Position Accessory + Single Reference Accessory

Includes the Peltier 9-Sample Position Accessory for the sample position and the Single Reference Accessory for the reference position. Also included are 5 beam masks, alignment gauge, reference position cover, sample compartment extension, power supply, cables, and User's Guide. Selectable temperature range 20 °C to 45 °C. Must be service installed. Requires the LAMBDA 25, 35, 45 Accessory Board (L6000500).

LAMBDA Model	Part No.
1X/2X/3X/4X/Bio	N1010566

Routine Peltier Single Sample Accessory

Peltier temperature controlled single cell holder for the sample position. Also included are a reference position cover, power supply, power cables, and User's Guide. Selectable temperature range 20 °C to 45 °C. Requires the LAMBDA 25, 35, 45 Accessory Board (L6000500).

LAMBDA Model	Part No.
1X/2X/3X/4X/Bio	B2000159

Routine Peltier 9-Sample Position Accessory

Includes the Peltier 9 position cell changer, 5 beam masks, alignment gauge, reference position cover, sample compartment extension, power supply, power cables, and User's Guide. Must be service installed. Selectable temperature range 20 °C to 45 °C. Requires the LAMBDA 25, 35, 45 Accessory Board (L6000500).

LAMBDA Model	Part No.
1X/2X/3X/4X/Bio	B2000160

Routine Peltier Single Reference Accessory

Peltier temperature controlled single cell holder for the reference position. Also included are the power supply, power cables, and User's Guide. Selectable temperature range 20° to 45 °C. Requires the LAMBDA 25, 35, 45 Accessory Board (L6000500).

LAMBDA Model	Part No.
1X/2X/3X/4X/Bio	B0510412

9-Position Cell Holder

As included with the Peltier 9-Sample Position Accessory. Additional interchangeable cell holder for use with the 9-position cell changer.

LAMBDA Model	Part No.
1X/2X/3X/4X/Bio	B0510366

Stirring Rods Set of 15 pieces for stirring in the cuvette.

For use with the Research Peltier System-6 Position (PTP-6) (L6310011), and 13-Cell Changer Systems (B0185210), and Magnetic Stirrer Accessory (B0507355 and B0510070).

LAMBDA Model	Part No.
1X/2X/3X/4X/Bio	B0187028

PTP-A Single-cell Air-cooled Peltier Accessory

The PTP-A Single-cell Peltier Accessory is air-cooled and does not require a source of cooling water, making it very convenient to use with minimal setup time. Temperature programs are set up, edited and stored from the front panel of the controller unit.

The PTP-A is ideal for protein and nucleic assays to 37 °C and for many studies of kinetics, thermodynamics and acid-base equilibria.

Description	Part No.
PTP-A Single-cell Air-cooled Peltier System	L6310014

Water-thermostatted Single-cell Holder

A single-cell holder with 3 mm fluid tubing connectors to enable fluid circulated temperature stabilization. Can be installed in the reference position with the PTP-1 and PTP-6 to allow the reference sample to be temperature controlled. Requires, but does not include, a fluid circulator.

Description	Part No.
Water-thermostatted Single-cell Holder	B0080819

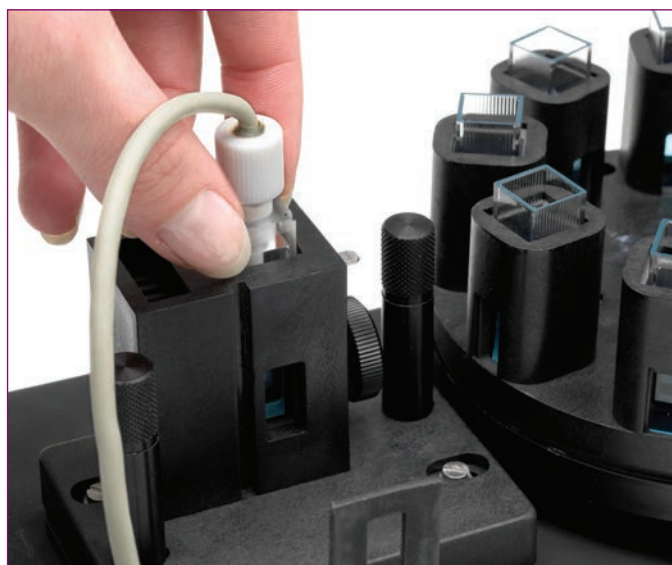

Temperature-measurement Kit

Temperature-measurement Kit

Probe for measuring the temperature within the cell. Includes glass cell. Requires the LAMBDA 25, 35, 45 Accessory Board (L6000500).

Description	Part No.
Temperature-measurement Kit	B0185227

Research Peltier Systems



PTP 1+1 and PTP 6+6 Research Peltier Systems

The research Peltier range of accessories is ideal for any application that requires precise control of temperature at, below or above ambient temperature. The ability to operate up to 100 °C allows applications such as DNA melting, protein denaturation and some polymer studies to be performed.

These accessories consist of Peltier-controlled, single or six-cell cuvette holders for the sample and reference channels. Single-channel versions are also available. The accessory includes in-cuvette stirring and the ability to preset temperature programs. These units require a source of cooling water.

Description	Part No.
PTP-1 Research Peltier System	L6310010
PTP 1+1 Research Peltier System	L6310012
PTP-6 Research Peltier System*	L6310011
PTP 6+6 Research Peltier System*	L6310013

*For the PTP-6 and 6+6 the sample and reference cell holders must be fitted to the baseplate of the cell changer unit in the sample compartment. In a Lambda 25, 35 or 45 this is the Automatic Linear Transport (B2000186), while in a Lambda 650, 850, 950 or 1050 the Linear Cell Programmer (B2205401) is required.

Peltier Controlled Fluid Circulator (PCB1500)

An external fluid circulator for use with all thermostatted cell holders enabling peltier effect temperature control. With both heating and cooling ability the circulator provides a temperature range of 20 °C to 60 °C with an accuracy of +/- 0.1 °C. Also included is a serial port and documentation to enable PC programming.

Description	Part No.
Peltier Controlled Fluid Circulator (PCB1500)	N1015158



The Fully-automated Universal Reflectance Accessory (URA)

PerkinElmer's unique Universal Reflectance Accessory (URA) is the only fully-automated, multi-angle, absolute specular reflectance accessory available today. For the Lambda 650/850/950/1050.

Simply place the sample on the horizontal sampling plate, select the required measurement angles with a few mouse clicks and scan. Unlike traditional methods, the URA automatically and reproducibly changes the measurement angle, eliminating time-consuming manual mirror adjustments and changes of accessory. This approach reduces running costs and increases productivity. The URA snaps into place in the second sampling position and can quickly be interchanged with integrating spheres and other detector modules.

Features and Benefits

- Measurement range: 190 – 3,100 nm (UV/Vis/NIR), 190 – 900 nm (UV/Vis)
- Angular range: 8° – 68° incident angle
- Depolarization recommended for angles >15°
- Measure separate S&P polarizations using the Double Depolarizer Drive (B0505530)
- Absolute and relative measurements can be made
- Typical applications include the measurement of anti-reflection coatings, high-reflectors, coating thickness and metallic reflectors

Description	Part No.
URA* (UV/Vis only)	L6020208
URA* (UV/Vis/NIR)	L6020202
URA (UV/Vis/NIR) for LAMBDA 1050 only	L6020358

*Not available for the LAMBDA 750

Relative Specular Reflectance Accessories

For reflectance or thickness measurements. 6° angle of light incidence. For Lambda 25/35/45/650/750/850/950/1050.

Features and Benefits

- Locates in the standard sample compartment for routine relative reflectance measurements at a 6° fixed angle of incidence
- Accommodates samples from 20 x 20 mm to 100 x 100 mm
- Wavelength range: 175 – 3,300 nm

Description	Part No.
Relative Specular Reflectance Accessory	B0086703

Variable-Angle Relative Specular Reflectance Accessory

For relative specular reflectance studies which require data from more than one angle of incidence, the variable angle accessory is ideal. The angular range is from 15 to 70° with an accuracy of +/- 1°. Typical applications include the study of the how the reflectivity of a sample changes with change of incident angle. For the Lambda 25/35/45/650/750/850/950/1050.

Features and Benefits

- Wavelength range: 175 – 3,300 nm
- Locates in standard sample compartment
- Range of angles: 15 – 70°

Description	Part No.
Variable-Angle Relative Specular Reflectance Accessory	B0137314

Spare Standard Mirror

For Relative Specular Reflectance Accessory, 6° (B0086703) and Variable Angle Reflectance Accessory (B0137314). This mirror is not calibrated.

Description	Part No.
Spare Standard Mirror	B0071519

Powder Sample Holder Set

For measurement of powder samples.

Description	Part No.
Powder Sample Holder Set	PELA9040



150 mm Integrating Sphere

Snap-in Integrating Spheres for Lambda 650/750/850/950/1050

PerkinElmer's range of snap-in integrating spheres is the industry standard for the measurement of total reflectance, diffuse reflectance and diffuse transmittance measurements for a huge range of sample types. The 150 mm Integrating Sphere is the recommended accessory for measurement of total solar reflectance and transmittance in the glass industry and for the measurement of UV transmittance of paint films in the automotive industry. Many national laboratories use it in R&D studies and for calibration measurements.

The 60 mm and 100 mm Integrating Sphere are used for routine diffuse reflectance and diffuse transmittance measurements. The detector sphere comprises a 60 mm Spectralon detector sphere contained in a snap-in module which fits into the second sample compartment position. This leaves the primary sample compartment free for the use of accessories such as the V-N absolute reflectance accessories, transmission sample holders and polarizer/depolarizer drive.

Features and Benefits

- Measurement range: 200 – 2,500 nm (UV/Vis/NIR), 200 – 900 (UV/Vis)
- InGaAs versions offer higher sensitivity in the near-IR range
- Sampling modes include total and diffuse reflectance at an incident angle of 8°, and total and diffuse transmittance at normal (0°) incidence

Description	Part No.
150 mm Integrating Sphere*	L6020204
60 mm Integrating Sphere	L6020203
60 mm Detector Sphere*	L6020209
150 mm InGaAs Integrating Sphere*	L6020322
60 mm InGaAs Integrating Sphere*	L6020323
100 mm InGaAs Detector Integrating Sphere**	L6020371
100 mm PbS Detector Integrating Sphere**	L6020372

*Not available for the LAMBDA 750

**For all LAMBDA high performance units: 650, 750, 850, 950, 1050

Accessories for LAMBDA 150 mm Integrating Spheres

Center Mounted Sample Holder, Clip Style

Clip style for films and paper samples.

LAMBDA Model	Part No.
6XX/8XX/9XX/10XX	PELA9039

Center Mounted Sample Holder, Jaw Style

Jaw style for solid samples like glasses, prisms, etc.

LAMBDA Model	Part No.
6XX/8XX/9XX/10XX	PELA9038

Cell Holder

For measurement in 1 cm cuvettes in transmission or reflectance mode.

LAMBDA Model	Part No.
6XX/8XX/9XX/10XX	C6951019

Small Spot Accessory Kit

Lens kit for reducing beam size to the transmittance position, to the center mount and to the diffuse reflectance position. Requires Reflectance Aperture Kit, Part No. L6020314.

LAMBDA Model	Part No.
6XX/8XX/9XX/10XX	L6020211

Reflectance Only Small Spot Kit

Lens kit for reducing beam size to the reflectance position. Requires Sample Compartment Iris, Part No. L6020316.

LAMBDA Model	Part No.
6XX/8XX/9XX/10XX	L6020313

100 mm Integrating Spheres for LAMBDA 650, 750, 850, 950, 1050

Description	Part No.
Cuvette Holder	L6022022
Powder Cell Holder	L6022025
Reference Sample Holder	L6022018
Transmittance-only Small Spot Kit	L6022023
Reflectance-only Small Spot Kit	L6022024

50 mm Integrating Sphere for Lambda 35

Simplifies analysis of a wide variety of samples, including solids, powders, pastes and liquids. For scattered transmittance and diffuse reflectance measurement. Spectralon coated, wavelength range 250 to 1,100 nm.



LAMBDA Model	Part No.
LAMBDA 35	C6951014

Accessories for LAMBDA 35 Integrating Spheres

Description	Part No.
1.25" Calibrated Spectralon Diffuse Reflectance Standard	PELA9057
Powder Sample Holder Set	PELA9040

PRECISE TRANSMISSION AND REFLECTANCE MEASUREMENTS

Double Polarizer drive for LAMBDA 650/750/850/950/1050



When samples are oriented and polarize incident light, it is important to correct for the inherent polarizing effect of the spectrometer's optics by using a depolarizer. Another important application is to make measurements using a specific orientation of incident radiation e.g. for crystalline materials and polymers.

Features and Benefits

- Measurement range (Depolarization): 185 – 2,600 nm
- Measurement range (with Polarizers): 400 – 700 nm (Film), 300 – 2,600 nm (Glan-Thompson), 210 – 1,000 nm (Glan-Taylor)
- Fits into standard sample compartment alongside reflectance accessories and transmittance sample holders
- Suitable for reflectance and transmittance measurements

The high performance Double Polarizer/Depolarizer Drive is installed in the primary sample compartment. The polarization/depolarization orientation can be fully automated, changed by a scan at a fixed wavelength or with a stepping mode. Resolution of 0.25° for scanning. The polarization (depolarization) orientation in the stepping mode can be changed at up to 20 wavelength positions. Applications include specular reflectance studies of optics, coatings, metallic reflectors and thin films. The Double Polarizer Drive can operate with the Universal Reflectance Accessory or manual specular reflectance and transmission accessories.

Description	Part No.
Double Polarizer drive for LAMBDA 650/750/850/950/1050	B0505530

The Double Polarizer Drive requires, but does not include, one or two of the following polarization elements:

Polarizer/Depolarizer Elements for the Double Polarizer Drive

A range of polarizing materials is available, according to the required wavelength range. For equal energy in the sample and reference beams of the spectrometer, two are required.

Description	Wavelength Range	Part No.
Film Polarizer	400 – 700 nm	B2205022
High Performance Polarizer Crystal	300 – 2,600 nm	B0505284
Glan-Taylor Polarizer Crystal	210 – 1,000 nm	N1010520
Depolarizer Crystal (98% efficiency)	190 – 2,600 nm	B2205021

Common-beam Depolarizer

Another approach to depolarization involves the use of a software controlled depolarizer inside the spectrometer. Driven by a stepper drive, and controlled by UV WinLab™ software, the Common-beam Depolarizer operates between 190 and 2,600 nm uses a double-wedge quartz/Suprasil design for 92% depolarization efficiency. Service installation is required.

Description	Part No.
Common Beam Depolarizer	B0501282

Sipper

Peristaltic Sipper "PESI"

Sampling and purging time selectable from keyboard.

For LAMBDA 25/35/45/10/20/40 no accessory PCB necessary. Requires, but does not include, accessory PCB for LAMBDA Bio 11, 12, and 14, (B0509681/B2190034) or accessory PCB for LAMBDA 18/19 (B0124984/B0116378).

For LAMBDA 6XX/8XX/9XX/10XX, requires, but does not include, Installation Kit for LAMBDA 800/900 (B2500123) and Accessory PC Board for LAMBDA 800/900 (B2205116).

Requires, but does not include, Flowcell of choice with screw connector.

Description	Part No.
Peristaltic Sipper PESI	B2190036

FIBER OPTICS ACCESSORIES



Transfer-Optic for 1X/2X/3X/4X/Bio Part No. B0509546

Transfer-Optic for Mono-Fibers

Fiber optic transfer holder for LAMBDA spectrophotometers. Requires pair of Mono-Fibers 2x2 or 2x10 meters and/or optrode. Other optrodes available on request.

LAMBDA Model	Part No.
1X/2X/3X/4X/Bio	B0509546
650/850/950/1050	L6020290

Pair of Mono-Fibers

2x2 meters each.

Wavelength	Part No.
250 to 900 nm (UV/Vis)	B0196912
400 to 2400 nm (Vis/NIR)	B0509591

Fiber Optic Dip Probe

The Fiber Optic Dip Probe is a 15 mm, 316 grade stainless steel probe with a wavelength of 200-1100 nm. Requires but does not include: Transfer-Optic for Mono-Fibers, Light Shield (N1016074) and one of the following Probe Tips: Probe Tip, 2 mm pathlength (N1016073); Probe Tip, 5 mm pathlength (N1016072); or Probe Tip, 10 mm pathlength (N1016071).

LAMBDA Model	Part No.
All	N1016070

Light Shield

For use with Fiber Optic Dip Probe (N1016070).

LAMBDA Model	Part No.
All	N1016074

Probe Tip

For use with Fiber Optic Dip Probe (N1016070).

Pathlength	Part No.
2 mm	N1016073
5 mm	N1016072
10 mm	N1016071

GENERAL PURPOSE OPTICAL BENCH KITS FOR THE LAMBDA 6XX/8XX/9XX/10XX

General Purpose Optical Bench (GPOB)

General Purpose Optical Bench for Lambda 650/850/950/1050

The GPOB features a magnetized, ruled optical bench with a moveable 60 mm Spectralon® or InGaAs Spectralon® collection integrating sphere. Samples up to 400 mm in pathlength can be analyzed using the General Purpose Optical Bench. Wavelength Range: 190 nm to 2500 nm.

Description	Part No.
General Purpose Optical Bench	PELA1003
InGaAs General Purpose Optical Bench	L6020328

Sample Holder Mount Kit

Two cantilever sample holders with magnetic bases.

Description	Part No.
Sample Holder Mount Kit	PELA1005

Variable Angle Transmittance Sample Holder Kit

Holds samples at an accurately measured angle to the incident beam for measurement of transmittance. Samples can be up to 1 cm thick and up to 10 cm square.

Description	Part No.
Variable Angle Transmittance Sample Holder Kit	PELA1006

Optical Bench Kit

Two magnetized mounted iris diaphragms on two optical rails with mounts.

Description	Part No.
Optical Bench Kit	PELA1008

Short Focal Length Mirror Kit, Spot Incidence

Kit consists of a short focal length (20 to 30 mm) concave mirror on an adjustable base with magnetic mounts to allow for small spot incidence of curved samples.

Description	Part No.
Short Focal Length Mirror Kit, Spot Incidence	PELA1013

Beam Blocker Kit

Optical black beam blocker on adjustable base with magnetic mounts.

Description	Part No.
Beam Blocker Kit	PELA1014

Fiber Optic Measurement Stage and Holder Kit

Includes two fiber optic holders to allow for measurement of small diameter fibers and fixed apertures.

Description	Part No.
Fiber Optic Measurement Stage and Holder Kit	PELA1015

Polarimetry Cells

PerkinElmer offers a wide range of polarimetry sample cells for virtually all applications, including micro cells, short path cells, flow cells, and fused silica (quartz) cells. Use quartz cells for all wavelengths and for elevated temperatures (200 °C, maximum). Use glass cells only for visible wavelengths, above 400 nm.

Each of our polarimetry cells is individually tested with respect to its pathlength. The actual pathlength of each cell is engraved on the cell to the nearest 0.001 cm (i.e. to the nearest 0.01 mm), together with the serial number of the cell.

Cells are designed for easy filling and emptying. They are jacketed for thermostating with constant temperature water, except for one flowcell. Their residual cell rotation is almost zero and may be neglected in most measurements.

Standard Cells for Polarimetry

Material	Lightpath	Cell Vol.	Part No.
Quartz	100 mm	3.0 mL	B0507403
Quartz	100 mm	6.2 mL	B0041696
Optical Glass	100 mm	3.0 mL	B0507447
Optical Glass	100 mm	6.2 mL	B0041693

Short Path Cells for Polarimetry

Material	Lightpath	Cell Vol.	Part No.
Quartz, Fused Silica	20 mm	1.3 mL	B0022087
Optical Glass	10 mm	0.5 mL	B0017052
Optical Glass	1 mm	0.25 mL	B0017057

Micro Cells for Polarimetry

Material	Lightpath	Cell Vol.	Part No.
Quartz, Fused Silica*	100 mm	0.35 mL	B0131186
Optical Glass	100 mm	1.0 mL	B0017047

* With reduced inner diameter

Beaker Cells for Polarimetry

Beaker cells are not thermostatable.

Material	Lightpath	Cell Vol.	Part No.
Quartz, Fused Silica	100 mm	50 mL	B0023363
Optical Glass	100 mm	50 mL	B0017041

Flow Cells for Polarimetry

Material	Lightpath	Cell Vol.	Part No.
Quartz, Fused Silica*	100 mm	6.2 mL	B0507451
Optical Glass	100 mm	5.0 mL	B0017054

* With two PTFE tubing (4 mm i.d.)

Pluggable Coupling

For cell thermostating.

Connection	Part No.
Female	B0023491
Male	B0023492

PTFE Stopper

10 mm long.

Cell Compatibility	Diameter	Part No.
017 047/017 057/022 086 - 022 091/023 365/037 634/037 635/022 085/037 357	3 mm	B0017059
041 693/041 696	6 mm	B0041695

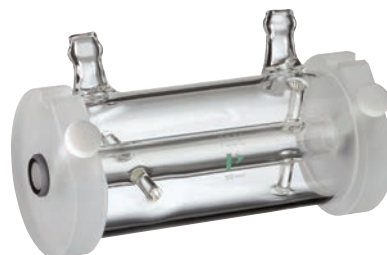

100 mm pathlength
Polarimetry Cell

Long Lifetime Source Lamps

High-quality source lamps, specially selected to optimize the performance of all PerkinElmer polarimeters, offer high radiant energy and a long operating lifetime. Their high output ensures that very accurate measurements of optical rotation can be made, even when the sample absorbs strongly.

Description	Polarimeter Model	Part No.
Sodium, 20 W	341/343/343plus/341LC/ 241/241MC/243/243B	L9004741
Mercury Vapor (St46)	341/343S/343plus/341LC	B0510581



Secondary Quartz Standards for Instrument Validation

Quartz control plates provide traceable instrument calibration in the visible spectral range, ensuring the highest standards of accuracy and precision for all measurements. All quartz control plates feature a thermostatable housing.

Description	Nominal Rotation	Part No.
Quartz Control Plate +1	+1° at 589 nm	B0098800
Quartz Control Plate -1	-1° at 589 nm	B0098799

Optional Interference Filter

For Model 341 Polarimeters. Service installation recommended.

Wavelength	Part No.
302 nm	B0094404
325 nm	B2100154
405 nm	B0062666



HIGH QUALITY CELLS FOR ALL APPLICATIONS

Standard rectangular macro cells are the most frequently-used type of spectroscopy cell for routine liquids analysis. Micro cells have the same outside dimension as the macro cells but the cell walls have been thickened, limiting the interior sample chamber width to 2 mm. This reduces the sample requirements by 80%.

For full details of the properties of Quartz SUPRASIL and Special Optical Glass see UV/Vis Macro Cells.

Macro with PTFE Lid or with PTFE Stopper

Material	Qty.	Light Path	Outside Dim. H x W x D	Inside Width	Base Thickness	Cell Volume	Windows	Part No.
with PTFE Lid								
Special Optical Glass	2	10 x 10 mm	45 x 12.5 x 12.5 mm	10 mm	1.25 mm	3.5 mL	4	B0631104
Quartz SUPRASIL®	2	10 x 10 mm	45 x 12.5 x 12.5 mm	10 mm	1.25 mm	3.5 mL	4	B0631107
with PTFE Stopper								
Special Optical Glass	2	10 x 10 mm	46 x 12.5 x 12.5 mm	10 mm	1.25 mm	3.5 mL	4	B0631110
Quartz SUPRASIL	2	10 x 10 mm	46 x 12.5 x 12.5 mm	10 mm	1.25 mm	3.5 mL	4	B0631113

Semi-micro with PTFE Lid or PTFE Stopper

Semi-micro cells have the same outside dimensions as the macro cells but the cell walls have been thickened slightly, limiting the interior sample chamber width to 4 mm. This reduces the sample requirements by 60%. Each package contains two cells with two clear windows each.

Material	Qty.	Light Path	Outside Dim. H x W x D	Inside Width	Base Thickness	Cell Volume	Windows	Part No.
with PTFE Lid								
Special Optical Glass	2	10 x 4 mm	45 x 12.5 x 12.5 mm	4 mm	1.25 mm	1.4 mL	4	B0631115
Quartz SUPRASIL®	2	10 x 4 mm	45 x 12.5 x 12.5 mm	4 mm	1.25 mm	1.4 mL	4	B0631116
with PTFE Stopper								
Special Optical Glass	2	10 x 4 mm	46 x 12.5 x 12.5 mm	4 mm	1.25 mm	1.4 mL	4	B0631117
Quartz SUPRASIL	2	10 x 4 mm	46 x 12.5 x 12.5 mm	4 mm	1.25 mm	1.4 mL	4	B0631118

Fluorescence Cells for Magnetic Stirrers

Material	Qty.	Light Path	Outside Dim. H x W x D	Inside Width	Base Thickness	Cell Volume	Windows	Part No.
Macro/Semi-micro								
Quartz SUPRASIL	1	4 x 4 mm	45 x 12.5 x 12.5 mm	4 mm	4.5 mm	500 µL	4	B0631132
Magnetic Stirrer Fleas	6							04978499

Micro with PTFE Lid or with PTFE Stopper

Material	Qty.	Light Path	Outside Dim. H x W x D	Inside Dim. width	Base Thickness	Cell Volume	Windows	Part No.
with PTFE Lid								
Special Optical Glass	2	10 x 2 mm	45 x 12.5 x 12.5 mm	2 mm	1.25	700 µL	4	B0631119
Quartz SUPRASIL	2	10 x 2 mm	45 x 12.5 x 12.5 mm	2 mm	1.25	700 µL	4	B0631120
with PTFE Stopper								
Special Optical Glass	2	10 x 2 mm	40 x 12.5 x 12.5 mm	2 mm	1.25	700 µL	4	B0631121
Quartz SUPRASIL	2	10 x 2 mm	40 x 12.5 x 12.5 mm	2 mm	1.25	700 µL	4	B0631122

Quartz SUPRASIL Ultra-micro with PTFE Stopper (B0631124)



Quartz SUPRASIL Micro with PTFE Lid (B0631120)



Quartz SUPRASIL Micro without Lid (B0631123)



Micro Cells without Lid

Material	Qty.	Light Path	Outside Dim. H x W x D	Inside Dim. H x W x D	Base Thickness	Cell Volume	Windows	Remarks	Part No.
Quartz SUPRASIL*	2	5 x 5 mm	33.5 x 7.5 x 7.5 mm	32.25 x 5 x 5 mm	1.25 mm	600 µL	5		B0631123
Quartz SUPRASIL*	2	5 x 5 mm	46 x 7.5 x 7.5 mm	38.75 x 5 x 5 mm	1.25 mm	850 µL	5	w/ PTFE Stopper NS 5	B0631142
Micro Cell Adapter	4								L2250139

*Requires Microcell Adapter (L2250139). Microcuvette Adapter allows 5 mm pathlength microcells to be used in any of the cuvette holders. (pkg. 4)

Ultra-micro Cells with PTFE Stopper

Ultra-micro cells use a narrower sample chamber, raising it directly into the center of the light path and masking it with black quartz. This design optimizes the use of smaller sample volumes. All Ultra-micro cells contain one cell and two clear windows.

Material	Qty.	Light Path	Center Height	Outside Dim. H x W x D	Aperture	Chamber Volume	Filling Volume	Windows	Part No.
Quartz SUPRASIL	1	10 x 2 mm	15 mm	45 x 12.5 x 12.5 mm	5 x 2 mm	100 µL	120 µL	3	B0631124

Quartz SUPRASIL Flow-through Cells for Fluorimetry (B0631126)



Flow-through Cells for Fluorescence Spectroscopy

Flow-through cells are used for measuring samples with continuous flow or with Sippers where individual samples are aspirated into the cell. All cells have center heights of 15 mm. Each package contains one cell with two clear windows. The cells listed below are compact with two screw connectors, M6x1 and 500 mm length FEP tubing – 1.9 mm o.d., 1.1 mm i.d.

Material	Qty.	Light Path	Outside Dim.	Inside Width H x W x D	Base Thickness	Cell Volume	Windows	Part No.
Macro Inlet/Outlet Tubes on Top								
Quartz SUPRASIL	1	10 x 6.5 mm	15 mm	45 x 12.5 x 12.5 mm	11 x 6.5 mm	750 µL	3	B0631126
Semi-micro Inlet/Outlet Tubes on Top								
Quartz SUPRASIL	1	10 x 4 mm	15 mm	45 x 12.5 x 12.5 mm	11 x 4 mm	450 µL	3	B0631127

*Compact with two (2) screw connectors and FEP tubing.

Temperature-controlled Cells for Fluorimetry

Material	Qty.	Light Path	Outside Dim. H x W x D	Inside Width	Base Thickness	Cell Volume	Windows	Part No.
Quartz SUPRASIL	1	10 x 4 mm	48 x 12.5 x 12.5 mm	4 mm	11 x 3.2 mm	1.4 mL	5	B0631125

HIGH-SENSITIVITY, ULTRA-STABLE LAMPS



Xenon Source Lamp

Xenon Source Lamps for LS30/40/45/50/50B/55

PerkinElmer Fluorescence Spectrometers use pulsed Xenon discharge lamps, which are not only very reliable and stable, but also provide remarkable sensitivity with a peak intensity exceeding 1 KW.

To maintain optimum stability and sensitivity of your instrument, installation of a new lamp by a PerkinElmer service engineer is recommended. Additionally, Xenon lamp quartz envelopes are under pressure, requiring eye protection and extreme caution in handling.

Description	Part No.
Xenon Source Lamp for LS30/40/45/50/50B/55	L2251157
Festoon Lamp for the LS Series*	04969486

*The Festoon Lamp is used along with the Xenon Lamp to maintain even triggering and stability.



Set of six Luminescence Sample Blocks

Checking the Day-to-Day Reproducibility of your Fluorescence Spectrometer

For day-to-day checks on reproducibility and wavelength calibration a set of six PMMA (polymethyl-methacrylate) blocks can be used. These have emission characteristics in the following wavelength ranges:

	Wavelength Range (nm)
1	300 – 400 (anthracene/naphthalene)
2	420 – 600 (ovalene)
3	300 – 400 (p-terphenyl)
4	400 – 600 (tetraphenyl/butadiene)
5	600 – 640 (europium)
6	540 – 640 (rhodamine B)

For checking instrument sensitivity, a 10 mm sealed cell contains high-purity water, which acts as a constant sample to reproducibly measure signal-to-noise using the Raman band.

Description	Part No.
Luminescence Sample Blocks (Set of 6)	52019600
Sealed Water Sample	L2251293

Red-sensitive Photomultiplier for the LS50B/45/55

The Red-sensitive Photomultiplier is a useful addition to the LS-series spectrometers to extend the detection range out to 900 nm. The full detection range is 200 – 900 nm.

Requires installation by a PerkinElmer service engineer.

Description	Part No.
Red-Sensitive Photomultiplier	L6020281

Ideal for Polarization Studies, Protein Folding and DNA Melting.

Changes in temperature affect fluorescence intensity. A simple, inexpensive and accurate way to control sample temperature is to use a thermostatable cell holder through which water from an external water-bath can be circulated. For temperature ramping studies and experiments where more rapid heating and cooling is required, a single-cell Peltier-thermostatted accessory is available.

Single-Cell Peltier Accessory

For analyses where more rapid heating and cooling is required, a single-cell, water-cooled Peltier accessory is available. Operation between 0 – 100 °C with a resolution of 0.1 °C makes it the ideal choice for a wide variety of applications, for example, thermal denaturation of proteins. Temperature control is via keypad or the optional TempScan software.

Description	Part No.
For LS50/45/55	
Single-cell Peltier Accessory	L2250150
BL Studio, FL	L2258003
BL Peltier, Add-on	L2258004

Requires a source of liquid cooling, such as a water-circulator.
Requires Accessory PCB Kit (L2250162) for use with LS-45

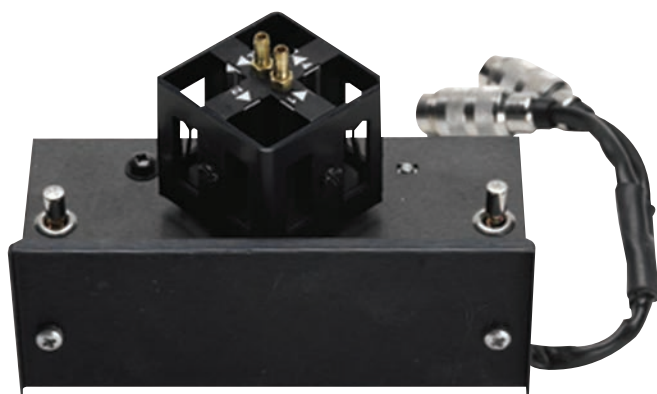

Four-position Thermostatted Automatic Cell Changer

Four-position Thermostatted Automatic Cell Changer

The Four-position Cell Changer accommodates four square, 10 mm pathlength cells or four micro-cells with adapters.

Description	Part No.
Four-position Thermostatted Automatic Cell Changer For LS50B/55	L2250134

Requires, but does not include, 4 Adapters (L2250139) to work with micro cells. Includes 6 Stirrer Fleas.

Single-position Thermostatted Cell Holder

Water-thermostatted cell holder for a 10 mm pathlength cell. This cell holder is included as standard with the LS-45 and LS-55.

Description	Part No.
Single-position Thermostatted Cell Holder For LS50B/45/55	L2250140

Single-position Thermostatted Cell Holder, with Stirrer

Cell holder with magnetic stirrer for a 10mm pathlength cell, water thermostatted. Includes six stirrer Fleas (04978499).

Description	Part No.
Single-position Thermostatted Cell Hold, with Stirrer	L2250141



Biokinetics Accessory for LS50/45/55

Biokinetics Accessory

The Biokinetics Accessory consists of a magnetically stirred single-cell holder with a built-in temperature sensor (0 – 100 °C) event marker. Thermostattable by an external water-bath (not included). Includes 6 Stirrer Fleas. Requires Accessory PCB Kit (L2250162) for use with LS-45.

Description	Part No.
For LS50/45/55	L2250145

Low-temperature Luminescence Accessory

For cooling samples to liquid nitrogen temperature. Used for measuring fluorescence or phosphorescence. Includes a pack of five sample tubes (52126027).

Low-temperature Sample Tubes

Description	Pkg.	Part No.
Low-temperature Luminescence Accessory		L2250136
Low-temperature Sample Tubes	5	52126027

INCREASE YOUR APPLICATION CAPABILITIES

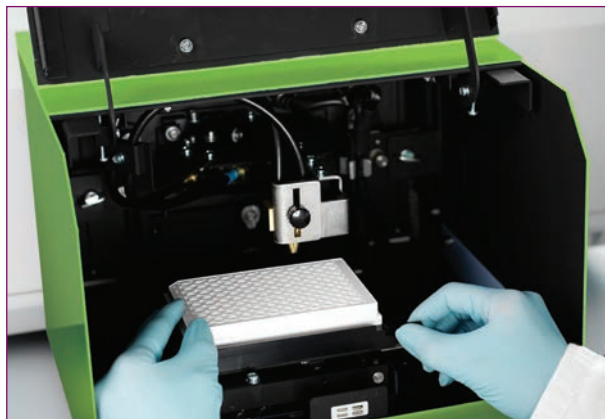

Fluorescence “Well-plate Reader”

Well-plate Reader Accessory for LS50B/55

The Well-plate Reader Accessory allows you to switch from a cuvette-based system to a well-plate reader in seconds. The accessory is front-mounted, providing easy access to standard well-plates.

Features and Benefits

- Measures in fluorescence, phosphorescence, bioluminescence and chemiluminescence modes
- Fiberoptic light feed for permanent alignment and high performance
- Standard or far-UV fiberoptics
- Easily removes and installs for switching between plate and cuvette measurements
- Can create programs for single end-point and kinetics analysis
- Optional plug-in software module allows the user to collect multiple spectra per well
- Measures up to 96 well plates

Description	Part No.
For work above 260 nm Excitation, 340 nm Emission	L2250035
For work above 260 nm Excitation and Emission	L2250042

Installation by a PerkinElmer service engineer is required. Includes one pack of white Microplates (L2251692).

96-Well Microplates

Description	Pkg.	Part No.
Hi-White flat bottom.	100	L2251692

Ideal for DNA Quantitation, Enzyme-linked Assays, Protein Measurements, Fluorescent ELISAs, Cell Viability Testing and Drug and Steroid Testing.

Liquid Sipper Accessory

The Liquid Sipper Accessory is ideal for the automation of liquid sampling, providing productivity improvements and sample-handling convenience. The accessory consists of a 16 microliter volume flowcell and a peristaltic pump controlled by the instrument software, which automatically transfers samples from the vessel to the cuvette.

Description	Part No.
For LS50B/55	L2250135

Includes Flowcell, Peristaltic Pump, 0.4 mm FEP Inlet Tube and 0.7 mm FEP Outlet Tube. Requires installation by a PerkinElmer service engineer.



Liquid Sipper Accessory

LC Flow Cell Accessory

The LC Flow Cell Accessory allows you to detect trace components eluted from a liquid chromatograph. Fluorescence can be monitored continuously at selected excitation and emission wavelengths, simply by replacing the standard cell holder with an LC flow cell.

Description	Part No.
For LS50B/45/55	L2250138

Includes Flowcell, Peristaltic Pump, 0.4 mm FEP Inlet Tube and 0.7 mm FEP Outlet Tube. Requires installation by a PerkinElmer service engineer.

High-sensitivity Alternative to a Dedicated LC Fluorescence Detector.



Remote Fiber-optic Accessory

Remote Fiber-optic Accessory

The Remote Fiber-optic Accessory allows you to make the measurement at the sample, without needing to take the sample to the instrument. Includes bifurcated synthetic fused-silica fiber-optics (1 m in length), which operate over the range 280 – 800 nm, and transfer-optics which mount in the spectrometer. This accessory is ideal for remote, non-destructive testing of fluorescent papers and fabrics, or remote sampling of hazardous materials.

Description	Part No.
For LS50B/45/55	L2250144

Total Emission Accessory

The Total Emission Accessory enhances the sensitivity of the fluorescence detection for samples with weak emission, and is recommended for bioluminescence and chemiluminescence experiments. The accessory uses a plane mirror that swings into place in front of the emission monochromator so that the total fluorescence of the sample can be measured.

The use of cut-off emission filters is recommended to reduce emission from other wavelengths. Five software-controlled emission filters are supplied with the LS55 spectrometers.

Description	Part No.
For LS50B/55	L2250101

Requires installation by a PerkinElmer service engineer.



Front-surface Accessory*

For Measurements on Solids, Powders and Viscous or Opaque Liquids

The simple-to-use Front-surface Accessory extends your measurement capabilities to a wide variety of solid and semi-solid samples, including powders, paper, plastic films, cloth samples, TLC plates, gels and turbid liquids. The accessory can be used with the LS-50B/45/55 spectrometers.

Features and Benefits

- Used for fluorescence and phosphorescence measurements
- Sample can be placed in the accessory directly or held in the synthetic fused silica window powder holder
- Ultra-small volumes or viscous samples can be sandwiched between the two windows
- Opaque and turbid samples can be measured in small cuvettes (under 10 mm)

Description	Part No.
Front-surface Accessory	52123130
Powder Sample Holder	
For use with Front Surface Accessory (52123130)	52123164
Synthetic Fused Silica Window	
For Powder Sample Holder	52123814

*Includes Powder Sample Holder (52123164).

DSC SAMPLE PANS, COVERS AND CRIMPERS

Standard Sample Pan Crimper Press

Used to crimp covers on standard DSC pans of aluminum, gold and copper. Design incorporates a replaceable crimper head.



Description	Part No.
Standard Sample Pan Crimper Press	02190048

Universal Crimper Press

The Universal Crimper Press provides high quality pan sealing for the autosampler sample pans/hermetically sealed pans and can also crimp standard aluminum pans, large volume stainless steel (24 bar) and volatile pans. This is achieved simply by using the appropriate sealing insert. Includes sample pan suction tool and inserts to seal 10, 30 and 50 µL sample pans.



Description	Part No.
Universal Crimper Press	B0139005

ALUMINUM SAMPLE PANS AND COVERS

Sample Pan	Operating Range	Vol. (µL)	Max Pressure	Qty.	Crimper (Sealer)	Part No.
Open/Crimped Pans						
▶ Standard Aluminum Pans and Covers	-170° to 600 °C	40	Ambient	400	02190048 or B0139005 with B0508921	02190041
▶ Supra clean Aluminum pans	-170° to 600 °C	40	Ambient	400	02190048 or B0139005 with B0508921	02192005
▶ Aluminum Sample Pans	-170° to 600 °C	28	Ambient	200	N5356027 or N5356028	N5356010
▶ Aluminum Sample Pans	-170° to 600 °C	45	Ambient	400	N5356027 or N5356028	N5356012
▶ Aluminum Pans for HyperDSC®	-170° to 600 °C	40	Ambient	100	Not Required	N5203115
Vented/Pierced Pans						
▶ Aluminum Covers (Pierced)	-170° to 600 °C		0.05 mm hole	400	B0139005	B7001014
▶ Volatile Aluminum Pans and Covers (Pierced)**	-170° to 600 °C	20	0.05 mm hole	100	02190061 or B0139005 with B0144637	N5190788
▶ Aluminum (Vented) Pans	-170° to 600 °C	30	Vented	400	B0139005	B0143018
▶ Aluminum (Vented) Pans	-170° to 600 °C	50	Vented	400	B0139005	B0143019
Hermetically Sealed/Volatile Pans						
▶ Aluminum Pans	-170° to 600 °C	10	1 bar	400	B0139005	B0143015
▶ Aluminum Pans	-170° to 600 °C	30	1 bar	400	B0139005	B0143016
▶ Aluminum Pans	-170° to 600 °C	50	1 bar	400	B0139005	B0143017
▶ Aluminum Covers (solid)*	-170° to 600 °C		1 bar	400	B0139005	B0143003
▶ Aluminum Covers (solid)***	-170° to 600 °C		3 bar	400	B0139005	B0143004
▶ Aluminum Pans and Covers	-170° to 600 °C	20	2 bar	400	02190061 or B0139005 with B0144637	02190062
▶ Aluminum Pans****	-170° to 600 °C	25	2 bar	400	B0139005	B0143020
▶ Aluminum Pans****	-170° to 600 °C	40	2 bar	400	B0139005	B0143021
▶ Aluminum Pans and Covers	-170° to 600 °C	10	3 bar	400	B0139005	B0169319
▶ Aluminum Pans and Covers	-170° to 600 °C	30	3 bar	400	B0139005	B0169320
▶ Aluminum Pans and Covers	-170° to 600 °C	50	3 bar	400	B0139005	B0169321
▶ Non-coated Aluminum Sample Pans and Covers	-170° to 500 °C	7.5	3 bar	200	N5356027 or N5356028	N5356008
▶ Aluminum Pans and Cover Starter Kit			3 bar	200/200	B0139005	B0510800
Photo DSC Pans						
▶ Aluminum Pans for Photocalorimetric Analysis	-170° to 600 °C	12.5	Ambient	100	Not Required	B0196858
▶ Aluminum Pans and Quartz Covers	-170° to 600 °C	12.5	Ambient	100	Not Required	B0198030
▶ Quartz Covers				10		B0181091
▶ Aluminum Pans and Covers - hand sealable	-170° to 600 °C	1	Ambient		Not Required	L90004787
▶ Aluminum Pans and Covers - 6.7 mm x 2.7 mm	-170° to 600 °C	1	Ambient		Not Required	L90004788
▶ For use with DSC 4000, DSC 6000, DSC 8000, DSC 8500, Diamond DSC, Pyris 1 DSC, DSC 7, DSC 6, Pyris 6 DSC and Jade DSC ▶ For use with Sapphire DSC						

* For use with B0143015, B0143016, B0143017

** 50 Micron hole; use for boiling point, heat of vaporization, sublimation studies.

*** For use with B0149319, B0149320, B0149321

**** Lids must be ordered separately as B0143003

High Pressure Capsule Sealing Tool

This reliable sealing tool is fast and precise. It employs a built-in torque clutch which guarantees that all capsules are closed with the same torque.



Description	Part No.
High-Pressure Capsule Sealing Tool	B0182864

Quick Press

The Quick Press is a convenient device for sealing stainless steel pans, covers and o-rings (03190218 and 03190029). Requires but does not include spacer die (03191047).

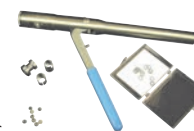

Description	Part No.
Quick Press	09908467
Quick Press Spacer Die	03191047

High Pressure Sample Pans (24 to 150 bar)

Pans contain the sample in a sealed environment throughout an experiment. The sealing suppresses the vaporization of a solvent or contains a volatile reaction product, thereby eliminating the interfering effects of the heat of vaporization.



Stainless Steel Pans with O-rings

Sample Pan	Operating Range	Vol. (µL)	Max Pressure	Qty.	Crimper (Sealer)	Part No.
▶ Stainless Steel Pans, Covers and O-rings	-40° to 300 °C	60	24 bar	20	B0139005 with B0505340 -or- 09908467 with 03191047	03190218
▶ Stainless Steel Pans, Covers and O-rings	-40° to 300 °C	60	24 bar	1,000	B0139005 with B0505340 -or- 09908467 with 03191047	03190029
▶ P20 High Pressure Pans and Covers	-170° to 310 °C	20	100 bar		09908467 with 03191047	L90004786
▶ High Pressure Stainless Steel Pans, Covers and Seals ¹	-170° to 300 °C	30	150 bar	5	B0182864	B0182901
▶ High Pressure Gold-plated Pans and Covers ¹	-170° to 400 °C	30	150 bar	5	B0182864	B0182902
▶ High Pressure Titanium Pans, Covers and Seals ²	-170° to 400 °C	30	150 bar	5	B0182864	B0182903
▶ Aluminum Sample Pans and Covers, High Volume ²	-170° to 500 °C	70	30 bar	40	N5356027 or N5356028	N5356002
▶ Aluminum Sample Pans and Covers, Small Volume ³	-170° to 500 °C	15	30 bar	40	N5356027 or N5356028	N5356003

¹ Reusable, includes 5 Pans and 20 Gold-plated Seals, uses Replacement Seals (B0182905)

² Reusable, includes 5 Pans and 20 Titanium Seals, uses Replacement Seals (B0185054)

³ Electric Sealer (N5356028) requires Hermetic Die (N5356032) and Stage (N5356035), included with Manual Sealer

Specialty Sample Pans and Covers

Sample Pan	Operating Range	Vol. (µL)	Max Pressure	Qty.	Crimper (Sealer)	Part No.
▶ Alumina Pans and Covers	-170° to 730 °C	40	Ambient	6	Not Required	N5190180
▶ Standard Copper Pans and Covers ⁶	-170° to 730 °C	40	Ambient	200	02190048	03190026
▶ Heat Treated Aluminum Pans and Covers	-170° to 600 °C	40	Ambient	100	Not Required	N5340188
▶ Graphite Sample Pans and Covers	-170° to 600 °C	40	Ambient	4	Not Required	03190025
▶ Gold Sample Pans and Covers	-170° to 730 °C	40	Ambient	10	Not Required	02190042
▶ Copper Sample Pans ^{4,5,6}	-170° to 800 °C	45	Ambient	200	Not Required	N5356021
▶ Aluminum Sample Pans, High Volume ^{2,3}	-170° to 600 °C	90	Ambient	200	N5356027 or N5356028	N5356034
▶ Ceramic Sample Pans ⁷	RT to 1,500 °C	25	Ambient	5	Not Required	N5356019
▶ Ceramic Sample Pans ⁷	RT to 1,500 °C	55	Ambient	2	Not Required	N5356020
▶ Platinum Sample Pans ⁸	-170° to 1,500 °C	45	Ambient	5	Not Required	N5356016
▶ Platinum Sample Pans, High Volume ⁸	-170° to 1,500 °C	95	Ambient	5	Not Required	N5356017

¹ Not for use with Autosampler ² Cover Crimp style (N5356014). Not for DSC Autosampler, requires Crimping Die and Stage (N5366030)

³ Cover Plate- style (N5356015)

⁴ Copper Mesh Cover (N5356022)

⁵ Stainless Steel Mesh Cover (N5356023)

⁶ Recommended for O.I.T. tests ⁷ No Covers ⁸ Plate Covers (N5356018)

▶ For use with DSC 4000, DSC 6000, DSC 8000, DSC 8500, Diamond DSC, Pyris 1 DSC, DSC 7, DSC 6, Pyris 6 DSC and Jade DSC ▶ For use with Sapphire DSC

Calibration Reference Materials

PerkinElmer reference materials are 99.999% pure. DSC requires elements of this purity so that the instrument can be accurately calibrated.

Reference Material	Transition Point	Part No.
Indium	156.60 °C	03190033
Tin	231.88 °C	03190034
Lead	327.47 °C	03190035
Zinc	419.47 °C	03190036
Encapsulated Kit*		02190045
Encapsulated Kit**		N5190762

* Includes a large and small indium, tin and lead

** Includes indium and zinc for DSC 4000, DSC 6000, DSC 8000, DSC 8500, DSC 7, Pyris 1 DSC, DSC 6, Pyris 6 DSC, Jade DSC and Diamond DSC



Specific Heat Kit

Includes four sapphire disks manufactured to two separate diameters and thicknesses. Also includes a calibration chart giving the specific heat of aluminum oxide in the form of synthetic sapphire.

Description	Part No.
Specific Heat Kit	02190136

Sample Holder Supplies

Sample Holder Cover Reforming Tool

DSC performance is enhanced with sample holder covers that are formed properly and not degraded by extended usage. This tool allows the analyst to reform the platinum covers to their original dimensions.

Description	Part No.
Sample Holder Cover Reforming Tool	03190030

Platinum Sample Holder Covers

Each cover has two vent holes and is used for the Diamond DSC, Pyris 1 DSC, DSC 7, DSC 8000 and DSC 8500 sample holders.

Description	Qty.	Part No.
Vented	2	04190299
Vented	6	03190031
DSC Autosampler, (2 required)	1	B0139122
Large furnace covers	2	B0182981

Sample Holder Cover Reforming Tool



Vented Platinum Sample Holder Cover

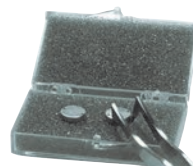

Hook Forceps

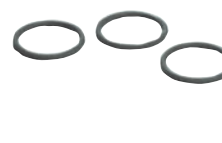

Diamond DSC Loading Tool

Allows for easy insertion and removal of sample or reference pans or platinum lids.

Description	Part No.
Diamond DSC Loading Tool	N5361180

Forceps

Description	Part No.
Flat Round Tips	09908400
Flat Pointed Tips	N5361078
Hook	09908138

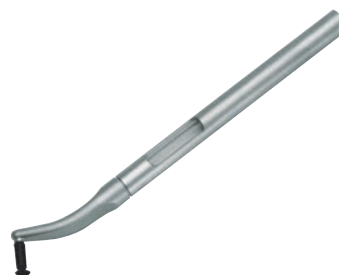

Sample Pan Manipulators

Features and Benefits

- Specially designed to simplify the pickup and positioning of your sample pans and covers.
- Prevents contamination of your sample.

Description	Part No.
Special Sample Pan Manipulator	B0142512
Standard Sample Pan Manipulator	B0143263
Replacement Rubber Tip	N5376097

WHEN FAILURE IS NOT AN OPTION



PerkinElmer offers a complete portfolio of consumables, accessories and supplies that deliver optimal performance in measuring the coefficient of thermal expansion (CTE), Tg, and TM in materials. Choose from a range of consumables and accessories with a cost efficient range of probes including expansion, compression, flexure, extension, and volumetric (dilatometry).

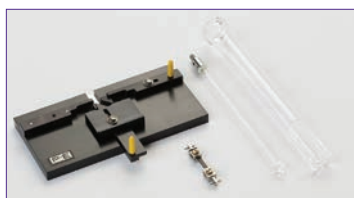

Analysis Kits

Complete sets of all the parts necessary for analysis of samples.

Description	Part No.
TMA Analysis Kit	L8040200
Advanced Analysis Kit	L8040202
Extension Kit	N5190619
Quartz Dilatometer (sm) Kit	03190461

Probes and Sample Tools

Probes

Probes and fixtures for special tests and as replacements of those included in kits.



Description	Part No.
Expansion Probe	N5190378
Extension Probe	N5190609
Flat Tip Penetration Probe	N5190376
Flexure TMA Kit	N5190399
Flexure Probe -3 Point Bending	N5190393
Short Expansion Probe	L8041800
Round Tip Probe - 0.5 mm	N5190377
Round Tip Probe - Large	N5190416

Sample Tools and other necessary parts

Complete sets of all the parts necessary for analysis of samples.



Description	Part No.
Aluminum Oxide Powder	04190197
Bending Anvil	N5391181
Ceramic Furnace Top	L8041808
Copper Film/Fiber Mounting Pins	02190322
Dilatometer (sm)	03191705
Extension Tube	N5191700
Extension Sample Clamp	N5190611
Halocarbon Oil 27	L9004783
Knurled Nut for Sample Tube	N5391054
Quartz Sample Tube	N5191549
Sample Load Fixture	N5190615
Sample Thermocouple	L8041809
Split Collar for Sample Tube	N5191662

Reference Materials

Standards for calibration of the TMA.



Description	Part No.
Aluminum Std Expansion 10mm x 3mm	L8041600
Aluminum Std Expansion 5mm x 3mm	L8041601
Indium Temperature Calibration Material	03190033
Quartz Displacement Standard	N5391051
Sapphire Disc - Thin Expansion Standard	02191269
Test and Calibration Weights	L8041801
Zinc Temperature Calibration Material	N5340229
Zinc T-Calibration Standard	03190036

Spares

Useful consumables and accessories you may need to operate your TMA.



Description	Part No.
Non-Magnetic Tweezers	09908400
Fuses 110V AC	L8041802
Fuses 220V AC	L8041803
Fuses 110/220V AC	L8041804
Hose clamps (4)	09903004
Tape: High Temperature	02507907
Tape: Thread Sealant	09908134
PTFE Tubing: 1/8" OD x 1/16" ID	02506483
Thermocouple	N5190417
Tygon Tubing: 1/2" OD x 3/8" ID	02506519
Turbulent Chamber Kit	L8040201
1/8" Swagelok Fittings (2)	09903906
Restrictor: Type A	01541496
Restrictor: Type H	01541498

ACCESSORIES

Furnace Accessories and Glassware

Description	Standard TGA Part No.	TGA High-Temp. Part No.
Furnace	N5190264	N5190172
Furnace Thermocouple		N5190196
Cup for Furnace, Thermocouple		N5191875
1 Sample Thermocouple	03190253	N5190197
2 Furnace Tube Quartz TGA 7	N5190203	
2 Furnace Tube Quartz PYRIS 1 TGA	N5370459	N5190202
Platinum Furnace Shield	03191628	
4 Balance Tare Weight	N5190282	N5190284
5 Cover O-ring	09902163	09902163

Furnace Accessories for STA 6000

Description	Part No.
STA 6000 SaturnA Sensor	N5202083

Hangdown Wire Kits



Hangdown Wire Link Kit, Quartz



Hangdown Wire Kit, Nichrome



Stirrup Kit, Platinum

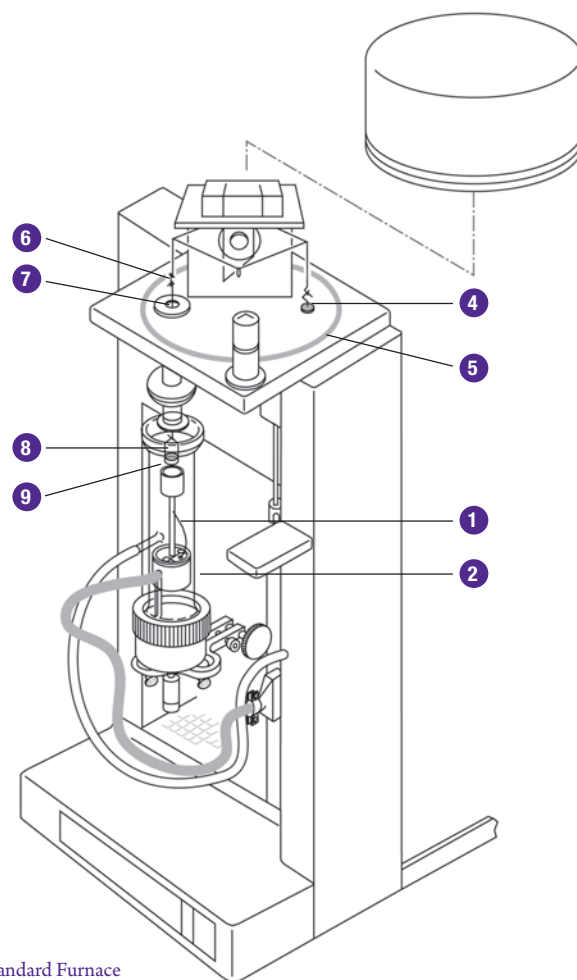

TGA Standard Furnace

Description	Material	Qty.	TGA 7 Standard Part No.	TGA 7 High-Temp. Part No.	PYRIS 1 TGA Standard Part No.	PYRIS 1 TGA High-Temp. Part No.
6 Hangdown Wire Link Kit	Quartz	10	N5190330			
Hanger Kit	Quartz	5			N5370487	
Autosampler Hanger Kit	Quartz	5			N5370488	
7 Hangdown Wire Kit Includes 6 preformed and 6 straight wires	Nichrome	6	N5190285			
Hangdown Wire Kit Includes 6 preformed wires	Nichrome	6	N5190516			
Hangdown Wire Kit Includes 6 straight wires	Nichrome	6	N5190515			
Hangdown Ribbon	Platinum	2			N5370478	N5370478
Autosampler Hanger Kit	Nichrome	5			N5370490	
7 Hanger Kit	Platinum	6				N5370330
7 Hangdown Wire Kit Includes 6 preformed wires	Platinum	6		N5190276		
8 Stirrup Kit	Platinum	4	03190265	N5190279	03190265	N5190279

Pans for TGA 7 and PYRIS 1 TGA

Description	Qty	Part No.
9 For TGA 7 Standard/PYRIS 1 TGA	4	03190264
9 For TGA 7/PYRIS 1 TGA High-temperature	4	N5190280
Ceramic Liner Kit for TGA 7/PYRIS 1 TGA	6	N5190283
PYRIS 1 TGA Accupik Sample Pans and Covers	400	N5370550

Pyris 1 TGA Autosampler Ceramic Crucible Kits and Liners

Description	Part No.
Ceramic Crucible Kit. Contains 10 ceramic crucibles.	N5370464
Aluminum Liners for Pyris 1 TGA Autosampler Ceramic Crucibles - Kit of 400	N5370492
Stainless Steel Liners for Pyris 1 TGA Autosampler Ceramic Crucibles - Kit of 400	N5370495

Pans for STA 6000, STA 8000, and TGA 4000

Description	Part No.
STA 6000/TGA 4000 Ceramic Sample Pan Kit - 45 Pans	N5200045
STA 6000/TGA 4000 Ceramic Sample Pan Kit - 3 Pans	N5200040
STA 6000/TGA 4000 Pt/Rh Pans (2.5 mm height) - 5 Pans	N5201021
STA 6000/TGA 4000 Pt/Rh Pans (5.0 mm height) - 5 Pans	N5201022
STA 6000/TGA 4000 Pt/Rh Pans (2.5 mm height) - 1 Pan	N5201023
STA 6000/TGA 4000 Pt/Rh Pans (5.0 mm height) - 1 Pan	N5201024

Pyris 1 TGA Accupik Replacement Needle Kit

Contains 3 needles.

Description	Part No.
Pyris 1 TGA Accupik Replacement Needle Kit	N5370554

Pyris 1 TGA Cooling Jacket

With this accessory and a Chiller (optional), the TGA can start from -20 °C.

Description	Part No.
Pyris 1 TGA Cooling Jacket	N5370553

Pyris TGA Volatile Capsule Sealer Kit

Description	Part No.
Pyris TGA Volatile Capsule Sealer Kit	N5370555

Forceps, Non-Magnetic

Description	Part No.
Hooked	09908138
Straight	09908400

CALIBRATION REFERENCE MATERIALS

Ensure accurate thermogravimetric measurements with PerkinElmer magnetic reference materials.

Description	Part No.
Kit of Five Reference Materials (Alumel, Nickel, Perkalloy, Iron and Hisat-50)*	02190071
Alumel Reference Material (154.2°C)	09988015
Nickel Reference Material (355.3°C)	N5190869
Perkalloy Reference Material (596°C)	N5190616
Iron Reference Material (780°C)	09988017
Indium Calibration Reference	03190033
Tin Calibration Reference	03190034
Lead Calibration Reference	03190035
Zinc Calibration Reference	03190036
Silver Calibration Reference	N5370438
Calibration Weight (TGA 6, TGA 4000, STA 6000)	N5200042
Calibration Weight (100 mg)	09908397
Calibration Weight Standards Kit for NOACK Lubricating Oil Test**	N5370140

* Magnetic Calibration Reference Materials are available in kit form and now are also available separately for your convenience. We recommend that you use fresh reference materials each time you calibrate your instruments. In this way you can avoid the effects of hysteresis and oxidation on the Curie point of the reference materials.

** Used to calibrate a TGA or STA to perform ASTM test method D5800 for evaporation loss of lubricating oils by the NOACK method.

COMPLETE RANGE OF ACCESSORIES

Cost effective Dynamic Mechanical Analyzer supplies for routine quality testing in the polymers, composites, pharmaceutical and food industries.

REPLACEMENT PARTS FOR THE DMA 8000

The DMA 8000 comes with a complete set of standard fixtures to allow tension, bending (3 type), shear and compression experiments.

Description	Part No.
Bending Clamp Set	N5330300
Shear Studs and Plate Set	N5330301
Shear Clamp Outer Assembly (pair)	N5330302
3 Point Bend Assembly	N5330305
Outer Clamp Supports – Stainless (pair)	N5330303
Outer Clamp Support – Single Side Only	N5330304
Extended Bending Clamp Set	N5330308
Compression Insert	N5330309
Extended Bending Clamp Set	N5330306
Miniature 3 Point Bending Clamp	N5330307
Extended Nut Set	N5330310
Full Nut Set	N5330311
Tensile Spacer Set	N5330313
Tensile Clamps (Titanium)	N5330312
Alignment Fixture	N5330314



Replaceable Parts For DMA 8000 Systems

Description	Part No.
Pt 100 Replacement Sensor	N5330253
Pyrex® Cup for Fluid Bath (set of 3)	N5330320
Screw set (4)	N5330338
Side Pillars and Screw	N5330303
Insert Compression (titanium)	N5330308
Replacement Omnicure® Light Pipe	N5365048
Replacement Omnicure® Bulb	N5365049
End cap for DMA 8000 Vent Cover	N5337031
Desiccant for Humidity Chamber (1 kg)	N5330405
Humidity Generator Sensor – calibrated	N5330402
Humidity Generator Heated Line	N5330403
Humidity Generator Sensor Lead	N5330404
Rod Microswitch Extension	N5331098

Calibration Supplies

Description	Part No.
PMMA Test Sample (set of 5)	N5330316
Steel Test Sample	N5330317
PVC Test Sample (set of 5)	N5330340
HDPE Test Sample (set of 5)	N5330341
Polycarbonate Test Sample (set of 5)	N5330342
PET Film Test Sample (set of 5)	N5330343
G10 Epoxy Test Sample (set of 5)	N5330344
Septum for compression (Set of 5)	00090652
Calibration Mass	N5330315
Temperature Calibration Kit Includes indium wire (1.5 mm dia), PMMA test sample (5) and FEB tube.	N5330318
Traceable Calibration Kit, DMA Testing Kit Includes micrometer caliper, calibration mass, PMMA test sample kit (5) feeler gauge, indium wire sample (2) and PTFE tube.	N5330319
Measuring System Training Kit Includes training manual, fairprene septum kit, acrylic sample (5), PVC sample (5), HDPE sample (5), polycarb sample (5), PET sample (5) and G10 sample (5).	N5330220
Dynamic Mechanical Analysis: A Practical Introduction (Menard)	N5374092

Cooling Accessories

The DMA 8000 has two options for sub-ambient operation: a 1-Liter Dewar for those needing occasional cooling, and a 50 L Dewar for those requiring longer or more frequent sub-ambient experiments.

Description	Size	Part No.
LN2 Cryo Dewar with Transfer Line and Fittings	1 L	N5330254
LN2 Cryo Dewar with Transfer Line and Fittings	50 L	N5373009



Material Pockets

Specialty Fixtures and Accessories

Special problems often require special tools and a wide range of options exist for the DMA 8000. Advanced software for special tasks, clamps for tablets, material pockets, photo-adapter for UV studies and fixtures that allow you to use the DMA 7 fixtures in the DMA 8000 are all available.

Description	Package	Part No.
Measuring System for Tablets For holding non-flat tablets, capsules and pills in compression. Can be used with the fluid bath or the humidity chamber as well as the standard furnace. One side is V-grooved and the other side has a round groove to allow a wide range of specimens to be held.		N5330604
Material Pockets For running pharmaceuticals, powders and other non-self supporting samples.	Set of 10	N5330322
	Set of 100	N5330323
	Set of 1,000	N5330324
Mesh Pockets For running pharmaceuticals, paints and other non-supporting samples where letting moisture and solvent in and out is desirable.	Set of 25	N5330177
	Set of 100	N5330178
DMA 7e Fixture Adapter Allows use of DMA 7 fixtures in DMA 8000.		N5330613
DMA Photo Adapter Allows use of DSC UV system light guides with DMA 8000.		N5337024
Fluid Bath Accessory* Allows immersion of samples.		N5330262
Humidity Generator** Allows testing in controlled relative humidity.		N5330400
Upgrade to Pyris SW Version 11 Controls the DMA8000 from within Pyris SW and includes TTS and Stress Relaxation.		N5340090

* Required for routine humidity work with Humidity Generator (N5330400).

** Requires Fluid Bath Accessory (N5330262).



Prepacked Tubes

Description	Est. Runs*	Part No.
CHN Oxidation Tube	1000*	N2410695
CHN Reduction Tube	150-180*	N2410694
CHNS Oxidation/Reduction Tube	120*	N2410693
O Pyrolysis Tube	1000*	N2410696
Scrubbing Tube (Argon Sealed)	250*	N2410697
CHNS/Oxygen Reduction Furnace	N/A	N2410698

*Estimated runs derived by PerkinElmer under ideal conditions, actual customer runs may vary.

Tubes

Description	Part No.
2400 CHN Kit	
Combustion and Reduction Tube and Reagent Kits and Tin Capsules. Quartz wool not included.	N2410683
2400 CHNS Kit	
Combustion/Reduction Tube, Reagent Kits and Tin Capsules. Quartz wool not included.	N2410684
CHN Prepacked Tube Kit	
One prepacked combustion tube and 3 prepacked combustion tubes.	N2410506
CHNS Prepacked Tube Kit	
Four prepacked CHNS combustion tube and a prepacked reduction furnace tube.	N2410507
O Prepacked Tube Kit	
One prepacked O combustion tube, 1 prepacked reduction furnace tube, and 4 prepacked scrubbing tubes.	N2410513
2400/2410 Maintenance Kit	
Includes O-Rings, Washers, Fuses and Springs Required for Routine Maintenance of the 2400 or 2410 Elemental Analyzers	N2410152

Packing Supplies

Description	Part No.
Silver Gauze Strip (Pkg 1)	N2410145
Platinum Gauze Strip (Pkg 1)	N2411273
Quartz Wool, (50 g)*	02401118
Copper Diffusion Plug, each	N2411333

*Only sold in the US due to export restrictions.

Calibration Standards

Description	Size	Part No.
Acetanilide	2 g	02401121
Benzoic Acid	4 g	02401120
Cystine	4 g	N2410324
EDTA	100 g	N2410325
Sulfamic Acid	10 g	N2410501



PerkinElmer genuine reagents will assure consistent and accurate results.

Reagents

Description	Part No.
EA-1000, (50 g)	N2410092
EA-1000, (3 x 50 g)	N2410166
Silver Tungstate/Magnesium Oxide, (100 g)	02401344
Silver Tungstate/Magnesium Oxide, (3 x 100 g)	N2410165
Silver Vanadate, (40 g)	02401117
Silver Vanadate, (3 x 40 g)	N2410164
EA-6000, (50 g)	N2410278
EA-6000, (5 x 50 g)	N2410331
Platinized Carbon, (10 g)	02400119
Copper Plus, (454 g)	02400117
Copper Plus, (10 x 454 g)	N2410157
Copper Plus – Wire Form, (454 g)	02401362
Copper Plus – Wire Form, (5 x 454 g)	N2410332
Copper for Nitrogen, (454 g)	N2411527
Copper for Nitrogen, (10 x 454 g)	N2410518
Copper Oxide – Wire Form, (454 g)	02401092
Aquasorb, (25 g)	N2410277
Colorcarb, (100 g)	02400115
Colorcarb, (3 x 100 g)	N2410188
Magnesium Perchlorate, (454 g)	02401119
Magnesium Perchlorate, (3 x 454 g)	N2410191
Thermolite, (100 g)	02400815

Receptacles

Description	Qty.	Part No.
Quartz Tube Insert	1	N2411401
Vial Receptacle, Metal (CHN Mode and 2410)	1	N2411335
Vial Receptacle, Metal (CHNS and Oxygen Modes)	10	N2410177
Vial Receptacle, Ceramic	1	09904866
Zirconia Cloth	1	N2410168

Sample Capsules and Sealers

Tin Capsules

For analysis of nonvolatile solid samples.

Description	Dims.	Qty.	Part No.
Standard Tin Capsule Kit	5 mm x 7 mm	96	N2411255
Standard Tin Capsule Kit, (pkg. 10)	5 mm x 7 mm	960	N2410155
Large Tin Capsule Kit	7 mm x 14 mm	250	N2411362

Flat Tin Disks

For analyzing 13 or 25 mm filters.

Description	Qty.	Part No.
Flat Tin Disks	100	N2411363
Flat Tin Disks, (pkg. 10)	1000	N2410244

Aluminum Capsules

For analyzing volatile liquid samples. Requires, but does not include, Liquid Sample Sealer (B0198093) and Tin Capsules.

Description	Qty.	Part No.
Aluminum Capsules, 4 μ L	1,000	02400642
Aluminum Capsules, 30 μ L	1,000	00090709

Tin Pans and Covers

For volatile liquid or solid samples, including viscous materials. Requires, but does not include, Volatile Sample Sealer (02190061).

Description	Qty.	Part No.
Volatile Tin Sample Pans and Covers	400	N2410320

Silver Capsules

For analyzing organic substances with Oxygen Analysis.

Description	Qty.	Part No.
Silver Capsules	96	N2411364

Sample Sealers

For use with volatile, nonviscous, noncorrosive samples.

Description	Part No.
Liquid Sample Sealer	B0198093
Spare Magazine for Liquid Sample Sealer	B0501078
Volatile Sample Sealer	02190061



Combustion and Pyrolysis Tubes

Tubes

PerkinElmer tubes are composed of pure fused quartz which is 99% SiO₂. Fused quartz has been chosen because of its very high purity and low thermal expansion rate. Because we care about your safety, all combustion tubes are pressure-tested to eliminate any tubes which might contain weak spots. In addition, stringent specifications are used to ensure that the combustion tubes fit in an airtight connection when placed in the analyzer.

Type	Material	Analyzer	Mode	Qty.	Part No.
Combustion	Quartz	2400	CHN	1	N2411264
Combustion	Quartz	2400	CHN	3	N2410212
Combustion	Quartz	2400	CHN	10	N2410153
Combustion/ Reduction	Quartz	2400	CHNS	1	N2411514
Combustion/ Reduction	Quartz	2400	CHNS	5	N2410330
Combustion/ Reduction	Stainless Steel	2410	Nitrogen	1	N2421070
Pyrolysis	Quartz	2400	Oxygen	1	N2411235
Reduction	Quartz	2400	Oxygen & Sulfur	1	N2411300
Reduction	Quartz	2400	CHN	1	N2411291
Reduction	Quartz	2400	CHN	10	N2410154
Scrubber	Pyrex®	2400/ 2410	Oxygen & Nitrogen	1	N2411359

PART NUMBER INDEX

Part No.	Page	Part No.	Page	Part No.	Page
00080100	207, 214, 216, 217, 218, 220	02190071	295	02542911	100
00090652	213, 296	02190136	292	02542912	100
00090699	117, 121	02190322	293	02542913	100
00090709	299	02191269	293	02542914	100
00091279	215	02192005	290	02542915	100
00091357	116	02200550	258	02542916	100
00091667	217	02400115	298	02542917	100
00230090	157, 241	02400117	298	02542918	100
00230091	241	02400119	298	02542919	100
00230111	112	02400642	299	02542920	100
00230177	112	02400815	298	02542921	100
00230178	112	02401092	298	02542922	100
00230253	241	02401117	298	02542923	100
00230522	243	02401118	298	02542924	100
00230523	212	02401119	298	02542925	100
00402237	152	02401120	298	02542926	100
00402239	148	02401121	298	02542927	100
00402240	148	02401344	298	02542928	100
00402241	148	02401362	298	02542929	100
00402243	148	02506483	157, 293	02580164	147
00403053	148	02506495	59, 164	02580166	147
00470258	90	02506516	41, 58	02580168	147
00470988	21	02506519	293	02580169	147
00472014	21	02507060	168	02580178	160, 165
00472020	34	02507907	293	02580191	147
00472022	34, 41	02507987	21	02580192	147
00473292	54	02508080	60	02580194	147
00473550	60	02509115	91	02580195	147
00473552	60	02540154	158	02580202	147, 165
00570559	90	02540177	158	02580203	147
00570567	90	02540197	158	02580204	147
00570948	21	02540272	160	02580213	147
00570984	21, 24	02540274	162	02580223	165
00572561	21	02540276	158	02580225	153
00572615	24	02540311	160	02711441	161
00572624	21	02540838	161	02712266	155
00873032	162, 168	02540871	160	02712273	155
00873035	161	02542076	158	02900540	73
00873036	161	02542313	158	03030106	90
00890873	162	02542783	100	03030133	25
00890893	152	02542880	100	03030135	25
00890945	162	02542881	100	03030204	90
00891480	161, 168	02542882	100	03030264	90
00891542	152	02542883	100	03030284	90
00891543	152	02542884	100	03030299	24
00891544	152	02542885	100	03030349	90
00903094	58	02542886	100	03030352	24
01541496	293	02542890	112	03030354	24, 25
01541498	293	02542891	112	03030402	24, 25
01860436	261	02542892	112	03030404	24
01860796	255	02542893	112	03030405	25
01860954	255	02542900	100	03030433	24
01862289	261	02542901	100	03030447	90
01862292	261	02542902	100	03030448	90
01862295	261	02542903	100	03030793	17
01862301	265	02542904	100	03030997	17
02190041	290	02542905	100	03030998	17
02190042	291	02542906	100	03031573	21
02190045	292	02542907	100	03031573	21
02190048	290	02542908	100	03031806	24
02190061	299	02542909	100	03190025	291
02190062	290	02542910	100	03190026	291

Part No.	Page	Part No.	Page	Part No.	Page
03190029	291	07110013	146	07110165	149
03190030	292	07110014	146	07110166	149
03190031	292	07110015	146	07110189	151
03190033	292, 293, 295	07110016	146	07110190	151
03190034	292, 295	07110017	146	07110191	151
03190035	292, 295	07110018	146	07110192	151
03190036	292, 293, 295	07110019	146	07110231	135, 145
03190218	291	07110020	146	07110232	135, 145
03190253	294	07110021	146	07110233	135, 145
03190264	295	07110022	146	07110234	135, 145
03190265	294	07110023	146	07110235	135, 145
03190461	293	07110024	146	07110236	135, 145
03191047	291	07110025	146	07120001	141
03191628	294	07110027	146	07120005	141
03191705	293	07110028	146	07120012	141
03300806	116	07110029	146	07120016	141
03300865	219	07110031	146	07120019	141
03300866	219	07110032	146	07120023	141
03300904	204	07110033	146	07120033	135
03300905	207	07110034	146	07120040	135
03302775	219	07110037	146	07120043	135
03302777	219	07110039	146	07120070	135
03302778	219	07110041	146	07120073	135
03302973	219	07110042	146	07120096	135
03302976	219	07110043	146	07120097	135
03302979	219	07110044	146	07120099	135
03302989	219	07110045	146	07150001	153
03303598	219	07110046	146	07150002	153
03303599	219	07110047	146	07150005	153
03303773	219	07110055	135, 145	07150006	153
04190197	207, 293	07110056	135, 145	07150012	152
04190299	292	07110057	135, 145	07150013	153
04800514	261	07110058	135, 145	07150014	153
04810949	261	07110059	135, 145	07150015	153
04820519	261	07110060	135, 145	07150016	153
04821008	257	07110061	145	07150017	153
04821131	257	07110062	145	07150018	153
04821132	257	07110064	145	07150019	153
04960691	265	07110066	145	07150020	153
04967843	265	07110073	135, 145	07150021	153
04967845	258, 265	07110074	135, 145	07150022	153
04967854	265	07110075	135, 145	07150023	152
04969486	155, 286	07110076	135, 145	07150024	152
04970673	225	07110077	135, 145	07150025	153
04977042	261	07110085	149	07150026	152
04977043	261, 265	07110086	152	07150028	153
04978064	225	07110087	149	07150029	153
04978499	284	07110088	152	07150030	153
04978532	116	07110089	149	07150031	153
5085685	262	07110090	152	07150032	153
6008103	262	07110091	149	07607537	262
6008104	262	07110092	152	09200064	45
7002356	262	07110093	149	09200078	42
7005386	262	07110095	149	09200079	25
7005397	262	07110096	152	09200091	225
7005398	262	07110098	152	09200122	21, 25
07110001	146	07110100	152	09200253	21, 25
07110002	146	07110102	152	09200271	25
07110003	146	07110105	152	09200272	25
07110004	146	07110106	152	09200273	25
07110005	146	07110114	149	09200274	25
07110006	146	07110163	149	09200275	25

PART NUMBER INDEX

Part No.	Page	Part No.	Page	Part No.	Page
09200276	25	09904941	165, 212, 213	09923464	91
09200277	25	09904943	165, 213	09923517	91
09200278	25	09904947	162, 168	09923536	60
09200369	25	09904956	162, 168	09926070	42
09210011	51, 54, 55	09904974	162, 168	09926083	25
09210012	54, 55	09904991	21, 25, 38	09926126	24
09220102	160	09905147	56	09926127	25
09220120	122	09907120	91	09938910	160
09220122	122	09907126	154	09972321	216
09410105	123	09907127	241	09985708	37, 48
09902005	24, 25	09907128	241	09985723	48
09902006	42	09907233	168	09988015	295
09902015	24, 25, 42	09907338	158	09988017	295
09902018	158	09907339	158	09989859	45
09902033	48	09907345	158	09992731	45
09902045	42	09907827	214	09995097	91
09902102	25	09907925	29	09995098	91
09902123	57, 59	09908134	293	10070900	163
09902128	158	09908138	292, 295	29000542	154
09902131	42	09908265	24, 25, 37	29000544	154
09902143	45, 214	09908324	158	29000545	154
09902147	21, 25	09908397	295	51000634	259
09902155	45	09908400	292, 293, 295	51000636	259
09902163	294	09908467	291	51000638	259
09902207	41, 42	09908585	58, 60	51000817	259
09902219	21	09908587	60	51001135	257
09902223	42	09908851	225	51001137	257
09902236	21	09919737	59	51001140	257
09902239	24, 25	09920104	200, 207, 228	51001141	257
09902240	21	09920105	200, 204, 228	51001144	261
09902247	42, 216	09920107	200	51001148	261
09902473	24	09920127	228	51001149	261
09903004	293	09920140	204	51001152	261
09903094	41, 58	09920141	200	51001188	256
09903128	209	09920301	204, 209	51001324	256
09903150	41	09920381	162, 168	51001325	256
09903289	162, 168	09920382	162, 168	51001326	256
09903392	204, 209	09920483	24	51001327	256
09903394	200	09920513	168	51001328	256
09903395	200	09920515	48	51001329	256
09903456	58	09920518	48	51002592	261
09903464	58	09921004	207, 209	51002593	261
09903465	58	09921028	41, 42	51004599	261
09903606	160	09921036	45	52019600	286
09903610	160	09921044	21	52123130	289
09903615	160	09921045	37, 48	52123164	289
09903700	200	09921057	45	52123814	289
09903771	157, 162, 168	09921061	42	52126027	287
09903891	162, 168	09921062	42, 45	54120790	225
09903906	157, 293	09923031	114	B0017041	283
09903980	162, 168	09923032	114	B0017047	283
09903981	200	09923037	60	B0017052	283
09904800	166	09923078	214	B0017054	283
09904802	163, 166	09923219	168	B0017057	283
09904805	166	09923270	168	B0017059	283
09904822	165, 213	09923304	168	B0017998	67
09904823	165, 212, 213	09923305	168	B0018283	64, 67
09904845	91	09923306	168	B0022087	283
09904846	91	09923307	168	B0023363	283
09904849	160, 165, 168	09923366	158	B0023491	283
09904866	298	09923367	158	B0023492	283
09904937	165, 213	09923448	60	B0029792	67

Part No.	Page	Part No.	Page	Part No.	Page
B0029796	67	B0143020	290	B0501078	299
B0038137	119	B0143021	290	B0501236	29
B0041693	283	B0143263	292	B0501282	281
B0041695	283	B0144169	228	B0501315	67
B0041696	283	B0152471	275	B0501377	120
B0046948	67	B0159356	119	B0501580	66
B0048139	64, 67	B0159357	119	B0501594	67
B0062666	283	B0165332	24	B0501595	67
B0066549	66	B0169319	290	B0501696	91
B0070126	67	B0169320	290	B0502706	91
B0070699	30	B0169321	290	B0503956	228
B0071519	279	B0169323	290	B0504033	28
B0080259	31	B0172053	63	B0504035	29
B0080819	278	B0174378	24	B0504036	29
B0080821	275	B0181091	290	B0505057	30
B0080822	275	B0182864	291	B0505071	275
B0086703	279	B0182901	291	B0505086	24
B0087056	26	B0182902	291	B0505284	281
B0087600	26	B0182903	291	B0505480	24
B0091504	30	B0182981	292	B0505530	280, 281
B0094404	283	B0185210	276	B0505590	24
B0098799	283	B0185227	278	B0505677	167
B0098800	283	B0187028	277	B0505983	24
B0099814	119	B0187258	67	B0506058	62, 67
B0101164	26	B0190634	29, 31, 73	B0506060	67
B0102332	26	B0190635	29, 31, 73	B0506143	24
B0104236	118	B0190672	24	B0506716	66
B0104239	119, 120	B0191058	67	B0506722	29
B0104240	119	B0191059	67	B0506737	62
B0104241	119, 120	B0191060	63, 62, 67	B0507020	67
B0104242	119	B0193161	62, 67	B0507021	67
B0104243	119, 120	B0193233	65	B0507226	73
B0104244	119	B0193234	65	B0507403	283
B0104281	26	B0193235	65	B0507447	283
B0104344	26	B0193342	66	B0507451	283
B0105197	30	B0193772	67	B0507486	66
B0105973	26	B0193873	66	B0507487	66
B0105974	26	B0194048	67	B0507692	62, 67
B0110728	119	B0194049	67	B0507805	269
B0114620	268	B0196704	66	B0507918	66
B0119079	26	B0196850	66	B0507919	64, 66
B0121092	30	B0196857	66	B0507920	66
B0128495	31	B0196858	290	B0507921	66
B0129258	26	B0196882	66	B0507949	66
B0129303	26	B0196912	282	B0507957	67
B0131186	283	B0198005	29	B0507959	67
B0131385	228	B0198030	290	B0507962	67
B0132799	26	B0198093	299	B0508306	67
B0135653	30	B0198097	67	B0508310	62, 67
B0137111	30	B0198099	67	B0508520	64
B0137113	30	B0198100	67	B0508901	65, 262
B0137314	279	B0198110	120, 228	B0509065	29
B0139005	290	B0198201	66	B0509479	67
B0139122	292	B0199034	62, 67	B0509546	282
B0142512	292	B0199035	66	B0509554	64
B0143003	290	B0199233	58, 66	B0509555	64
B0143004	290	B0500748	29	B0509591	282
B0143015	290	B0500833	120, 228	B0509612	67
B0143016	290	B0500952	275	B0510032	67
B0143017	290	B0500959	228	B0510334	66
B0143018	290	B0500987	228	B0510364	228
B0143019	290	B0501000	67	B0510366	277
		B0501056	64		

PART NUMBER INDEX

Part No.	Page	Part No.	Page	Part No.	Page
B0510370	66	B0631084	273	B3000132	64
B0510397	26	B0631085	273	B3000133	64
B0510398	26	B0631087	273	B3000135	64
B0510412	277	B0631088	273	B3000151	63
B0510581	283	B0631089	273	B3000152	63
B0510800	290	B0631090	273	B3000157	63
B0631001	270	B0631091	273	B3000158	63
B0631002	270	B0631092	273	B3000159	63
B0631003	270	B0631093	273	B3000160	63
B0631004	270	B0631094	273	B3000161	63
B0631005	270	B0631095	273	B3000243	66
B0631006	270	B0631096	273	B3000274	66
B0631007	270	B0631097	273	B3000342	30
B0631008	270	B0631098	273	B3000641	28
B0631009	270	B0631099	273	B3000653	28
B0631010	270	B0631100	273	B3000655	28
B0631011	270	B0631101	273	B3001253	30
B0631012	270	B0631102	273	B3001254	30
B0631013	270	B0631104	284	B3001256	31
B0631014	270	B0631107	284	B3001262	30
B0631015	270	B0631110	284	B3001264	30
B0631016	270	B0631113	284	B3001485	26
B0631017	270	B0631115	284	B3001505	26
B0631018	270	B0631116	284	B3001506	26
B0631019	270	B0631117	284	B3001507	26
B0631020	270	B0631118	284	B3001566	26
B0631021	270	B0631119	285	B3001567	26
B0631023	270	B0631120	285	B3001647	64
B0631025	270	B0631121	285	B3001769	63
B0631026	270	B0631122	285	B3001770	63
B0631027	270	B0631123	285	B3001771	63
B0631028	270	B0631124	285	B3001772	63
B0631029	270	B0631125	285	B3002006	26
B0631030	270	B0631126	285	B3002007	26
B0631031	270	B0631127	285	B3002046	26
B0631032	270	B0631128	273	B3002102	29
B0631033	270	B0631129	273	B3002103	29
B0631034	270	B0631130	273	B3120405	29
B0631035	270	B0631131	273	B3121301	31
B0631036	270	B0631132	284	B3130086	31
B0631039	271	B0631134	270	B3140236	64
B0631042	271	B0631142	285	B3140361	29
B0631045	271	B0631145	273	B3140362	29
B0631046	271	B0631149	273	B3140617	64
B0631047	271	B0631150	273	B3140618	64
B0631048	271	B0631151	273	B3140621	64
B0631049	271	B0631152	273	B3140622	64
B0631051	271	B0810377	45	B3140715	64
B0631057	271	B0851900	29	B3140721	62, 64
B0631060	271	B2000159	277	B3140730	62, 64
B0631064	271	B2000160	277	B3141064	73
B0631065	271	B2000186	276	B3150458	24
B0631066	271	B2000310	276	B3150525	24, 25
B0631070	271	B2100154	283	B3150531	24
B0631071	271	B2190036	281	B4000011	228
B0631076	271	B2205021	281	B4000022	119
B0631077	271	B2205022	281	B4000025	119
B0631079	271	B2500099	269	B4000028	119
B0631080	271	B2500100	269	B7001014	290
B0631081	271	B2500127	273	C0550303	275
B0631082	271	B2500129	273	C6951014	280
B0631083	271	B3000055	63	C6951019	280

Part No.	Page	Part No.	Page	Part No.	Page
CP183700	276	L1201944	252	L1271021	254
ED020005	162	L1201980	252	L1271102	257, 258
ED020015	161	L1202023	252	L1271191	257
ED020016	161	L1202024	252	L1271192	257
L0171159	267	L1202049	252	L1271193	257
L1003006	225	L1202050	252	L1271194	257
L1003008	225	L1202057	263	L1271195	257
L1003015	225	L1205436	252	L1271202	257, 258
L1003027	224	L1240098	263	L1271250	257
L1003028	224	L1241446	263	L1271602	257, 258
L1003029	225	L1242701	267	L1272002	257, 258
L1003030	224, 225	L1250046	252	L1272102	257
L1060351	261	L1250048	252	L1272126	250
L1180479	263	L1250050	250	L1272127	250
L1180480	263	L1250051	250	L1272130	253
L1180490	263	L1250052	250	L1272131	253
L1181303	258	L1250053	250	L1272133	253
L1185153	267	L1250054	250	L1272240	255
L1191079	262	L1250220	262	L1272243	255
L1191081	262	L1250240	252	L1272247	255
L1191082	262	L1250241	252	L1272248	255
L1200219	263	L1250242	252	L1272249	264
L1200253	263	L1250311	263	L1272265	265
L1200311	250	L1250404	263	L1272266	265
L1200312	250	L1250425	263	L1272267	265
L1200313	252	L1250462	263	L1272268	265
L1200314	252	L1250474	263	L1272274	253
L1200315	252	L1250475	263	L1272275	253
L1200316	252	L1251840	263	L1272276	253
L1200321	252	L1270301	257	L1272277	253
L1200323	252	L1270402	257	L1272282	259, 264
L1200324	252	L1270404	257	L1272283	259
L1200325	252	L1270408	257	L1272284	259
L1200333	252	L1270409	257	L1272288	259
L1200334	252	L1270410	257	L1272289	259
L1200335	252	L1270421	257	L1272290	259
L1200336	252	L1270512	257	L1272291	260
L1200337	252	L1270664	257	L1272292	260
L1200338	252	L1270665	257	L1272293	260
L1200343	252	L1270666	257	L1272294	260
L1200344	252	L1270765	257	L1272298	260
L1200345	252	L1270766	257, 258	L1272299	259
L1200346	252	L1270941	258	L1272300	259
L1200351	254	L1270942	258	L1272301	259
L1200406	263	L1270944	258	L1272302	259
L1200443	263	L1270947	258	L1272303	259
L1200551	262	L1270948	258	L1272307	260
L1200552	262	L1270949	258	L1272313	253
L1200553	262	L1270951	258	L1272314	253
L1200555	262	L1270952	258	L1272315	253
L1200556	262	L1270954	258	L1272316	253
L1200557	262	L1270957	258	L1272317	253
L1200558	262	L1270958	258	L1272318	253
L1200559	262	L1270959	258	L1272319	253
L1200560	262	L1270961	258	L1272320	253
L1200574	262	L1270962	258	L1272321	253
L1200587	262	L1270964	258	L1272323	253
L1200588	262	L1270967	258	L1272324	253
L1200589	262	L1270968	258	L1272325	253
L1201654	254	L1270969	258	L1272331	253
L1201655	254	L1270970	258	L1272332	253
L1201865	254	L1270986	257	L1272333	253

PART NUMBER INDEX

Part No.	Page	Part No.	Page	Part No.	Page
L1272334	253	L1272406	254	L1280064	252
L1272335	253	L1272407	251	L1280065	252
L1272336	253	L1272409	254	L1280066	252
L1272337	250	L1272410	254	L1280069	250
L1272338	253	L1272412	251	L1280301	250
L1272339	253	L1272414	251	L1280302	250
L1272340	253	L1272422	253	L1280303	250
L1272341	253	L1272423	251	L1280304	250
L1272342	253	L1272425	253	L1280305	250
L1272344	254	L1272426	253	L1280306	254
L1272345	254	L1272427	253	L1280308	250
L1272346	254	L1272428	253	L1280312	250
L1272347	254	L1272433	252	L1280321	250
L1272348	254	L1272440	260	L1280322	250
L1272349	254	L1272443	251	L1280323	254
L1272350	254	L1272450	255	L1281920	267
L1272351	254	L1272451	255	L1281921	267
L1272352	254	L1272452	255	L1281922	267
L1272354	259	L1272453	255	L1281923	267
L1272355	259	L1272454	255	L1281924	267
L1272356	259	L1272455	255	L1281925	267
L1272357	259	L1272456	255	L1281926	267
L1272358	259	L1272457	255	L1281927	267
L1272359	260	L1272458	254	L1281928	267
L1272361	255	L1272459	254	L1281929	267
L1272364	260	L1272461	254	L1281930	267
L1272365	260	L1272462	254	L1281931	267
L1272366	260	L1272463	254	L1281932	267
L1272367	260	L1272463	254	L1281933	267
L1272368	260	L1272470	259	L1281934	267
L1272369	260	L1272471	259	L1360266	252
L1272370	259	L1272472	260	L1360267	252
L1272372	251	L1272473	260	L1360268	252
L1272373	253	L1272474	260	L1360269	252
L1272374	253	L1272475	260	L1360270	252
L1272375	254	L1272480	260	L1360271	252
L1272376	255	L1272481	260	L1360272	252
L1272377	255	L1272482	260	L1360273	252
L1272377	255	L1272483	250	L1360275	252
L1272380	252	L1272484	253	L1365311	265
L1272381	251	L1272485	253	L1365312	265
L1272382	255	L1272486	253	L1600107	250
L1272383	255	L1272487	253	L1600109	250
L1272384	250	L1272487	253	L1600111	254
L1272386	251	L1272490	262	L1600113	250
L1272387	251	L1272490R	262	L1600114	250
L1272388	251	L1272491	261	L1600115	250
L1272389	251	L1272492	261	L1600116	250
L1272390	251	L1272493	261	L1600119	255
L1272391	251	L1272494	261	L1600130	258
L1272392	251	L1272495	262	L1600233	262
L1272393	251	L1272496	262	L1600238	262
L1272394	251	L1272498	262	L1600241	262
L1272395	251	L1272503	250	L1600242	262
L1272396	251	L1272504	250	L1600243	262
L1272397	251	L1272505	250	L1600243	263
L1272398	251	L1272506	250	L1600244	262, 263
L1272399	251	L1272511	250	L1600246	262
L1272400	251	L1272512	250	L1600350	262
L1272401	251	L1272513	250	L1608001	265
L1272402	251	L1272514	250	L1608002	265
L1272403	254	L1275102	254	L1608003	266
L1272405	254	L1275105	254		
		L1275106	254		

Part No.	Page	Part No.	Page	Part No.	Page
L1608004	266	L4275009	224, 225	L8041803	293
L1608005	266	L4275072	224	L8041804	293
L1608006	266	L4275089	224, 225	L8041808	293
L1608007	266	L4275107	224	L8041809	293
L1608008	266	L4275108	224	L90004786	291
L1608009	266	L4275110	224, 225	L90004787	290
L1608010	266	L6020202	279	L90004788	290
L1608012	266	L6020203	280	L9004128	262
L1608013	266	L6020204	280	L9004196	267
L1608015	266	L6020208	279	L9004198	262
L1608022	265	L6020209	280	L9004199	262
L1610021	262	L6020211	280	L9004200	262
L1610022	262	L6020281	286	L9004319	250
L1610023	262	L6020290	282	L9004573	267
L1610028	262	L6020313	280	L9004574	267
L1860268	264	L6020322	280	L9004575	267
L1860269	264	L6020323	280	L9004578	267
L1860275	264	L6020328	282	L9004741	283
L1860298	264	L6020329	269	L9004783	293
L1860317	264	L6020358	279	L9004892	267
L1860318	264	L6020371	280	M0410094	225
L1860319	264	L6020372	280	M0413535	224
L1860334	264	L6022018	280	M0413592	228
L1860361	264	L6022022	280	M0413593	228
L1860409	264	L6022023	280	M0413595	225, 227
L1861634	264	L6022024	280	M0413597	227
L2250035	288	L6022025	280	M0413598	225, 227
L2250042	288	L6022728	268	M0413625	225
L2250101	289	L6301054	225	M0413627	224
L2250134	287	L6310010	278	M0413628	224, 228
L2250135	288	L6310011	278	MZ101903-17	123
L2250136	287	L6310012	278	MZ105057-60180	123
L2250138	288	L6310013	278	MZ105094	123
L2250139	285	L6310014	278	MZ108391-5001	122
L2250140	287	L7110260	274	MZ108391-5002	122
L2250141	287	L7110261	274	MZ109004	123
L2250144	289	L7110262	274	MZ109017	123
L2250145	287	L7110264	274	MZ109197	123
L2250150	287	L7110265	274	MZ300061	122
L2251157	155, 286	L7110266	274	MZ300085	122
L2251293	286	L7110267	274	MZ300095	122
L2251692	288	L7110268	274	MZ300096	122
L2258003	287	L7110269	274	MZ300503	123
L2258004	287	L7110271	274	MZ301193	123
L4070023	224	L7110272	274	MZ301198	122
L4070207	225	L7110273	274	MZ301199	122
L4070208	225	L7110274	274	MZ301236	123
L4071029	225	L7110275	274	MZ305382	123
L4071034	225	L7110289	272	MZ305385	123
L4071123	225	L7110290	272	MZ321146	88
L4071151	224	L7110290	272	MZ321147	88
L4071594	225, 227	L7110291	272	MZ331300	122
L4135472	216	L7110291	272	MZ331301	122
L4270009	224	L7110292	272	N0171159	263
L4270010	224	L7110293	272	N0370392	21, 24
L4270128	227	L8040200	293	N0370393	24
L4270129	227	L8040201	293	N0370394	24
L4271106	224	L8040202	293	N0371505	37
L4271187	224, 225	L8041600	293	N0400058	21, 25
L4271203	224	L8041601	293	N0400100	20, 21
L4271205	224	L8041800	293	N0400101	20, 21
L4271290	224, 225	L8041801	293	N0400102	20, 21
		L8041802	293		

PART NUMBER INDEX

Part No.	Page	Part No.	Page	Part No.	Page
N0400103	20, 21	N0770420	41	N0775014	44
N0401171	21	N0770437	42	N0775177	41, 44
N0580531	91	N0770438	44	N0775220	91
N0581455	45	N0770546	37, 41	N0775223	44
N0581497	45	N0770600	38, 40	N0775224	44
N0582152	78	N0770603	44	N0775225	44
N0582184	44	N0770606	40	N0775226	44
N0582185	44	N0770607	40	N0775227	44
N0582186	44	N0770609	40	N0775228	44
N0582251	91	N0770610	37	N0775247	44
N0680275	45	N0770613	38	N0775289	41, 42
N0680504	34	N0770614	38, 41	N0775297	41, 42
N0680504	37, 48, 52	N0770689	41	N0775300	45
N0680612	48	N0770730	41	N0775325	91
N0681470	78	N0770731	41	N0775330	34
N0681574	34, 48	N0770732	41	N0775331	37
N0681631	54	N0770910	40	N0775340	35, 49
N0681690	42	N0770911	40	N0775341	49
N0690269	44	N0770916	42	N0775342	49, 58
N0690271	38	N0770944	45	N0775343	49
N0690568	42	N0770965	41	N0775344	49
N0690610	40	N0770965	41	N0775345	35
N0690640	39	N0771116	45	N0775346	34
N0690666	45	N0771500	41, 42	N0775347	34
N0690668	45	N0771501	39, 41	N0775348	34
N0690670	37	N0771526	44	N0775348	34
N0690672	45	N0771527	44	N0775349	34
N0690676	37	N0771529	63	N0775350	52
N0690712	40	N0771531	41, 44	N0775351	38
N0690720	39	N0771536	45	N0775352	39, 58
N0690769	44	N0771561	42	N0775355	39
N0690772	45	N0771725	47	N0775356	39
N0690812	40	N0771726	47	N0775358	35, 49
N0691579	72	N0772005	41, 42	N0776006	38
N0691580	78	N0772006	41	N0776007	38
N0691581	70, 78	N0772008	42	N0776014	41
N0691595	60	N0772017	38	N0776025	41
N0691662	42	N0773084	45	N0776052	38, 41
N0691664	42	N0773090	45	N0776053	39
N0691678	45	N0773106	47	N0776090	39, 41
N0691689	45	N0773111	60	N0776091	41, 44
N0691745	70	N0773112	60, 61	N0776093	41, 44
N0691907	87	N0773113	58, 60	N0776099	87
N0695295	42	N0773114	39	N0776103	84
N0695362	44	N0773115	60	N0776104	83
N0695379	42	N0773116	60	N0776105	83
N0695442	44	N0773117	60	N0776106	83
N0695449	44	N0773118	60	N0776107	83
N0695456	42	N0773119	60	N0776108	83
N0695460	44	N0773120	81	N0776109	83
N0695461	44	N0773196	51	N0776116	65
N0695476	60	N0773197	36	N0776118	65
N0695477	55	N0774067	61	N0777031	34
N0695494	44	N0774068	61	N0777032	34
N0695495	44, 54	N0774069	49	N0777033	34
N0770322	45	N0774070	41, 43	N0777034	51
N0770336	37	N0774077	36, 49	N0777035	51
N0770338	41, 42	N0774080	36, 49	N0777042	59, 60
N0770343	42	N0774085	64	N0777043	60
N0770344	42	N0774088	63	N0777044	44
N0770357	39, 41	N0774095	65	N0777049	36
N0770358	37, 41	N0774096	65	N0777051	43
		N0774101	38	N0777052	43

Part No.	Page	Part No.	Page	Part No.	Page
N0777053	43	N0777285	63	N0777606	46
N0777054	43	N0777286	63	N0777607	46
N0777055	43, 55	N0777298	64	N0777608	46
N0777061	36, 49	N0777328	91	N0777609	46
N0777062	64	N0777359	91	N0777610	46
N0777063	84	N0777360	91	N0777611	46
N0777064	84	N0777364	53	N0777612	46
N0777071	65	N0777413	36	N0777613	89
N0777072	65	N0777414	34	N0777676	36
N0777095	87, 91	N0777415	55	N0777681	89
N0777110	60	N0777416	55	N0777682	89
N0777111	34	N0777417	55	N0777689	89
N0777112	34	N0777419	55	N0777690	89
N0777113	34	N0777420	55	N0777691	65
N0777114	34	N0777435	36, 49	N0777692	65
N0777115	34	N0777436	36, 49, 61	N0777693	65
N0777116	34	N0777437	36, 49	N0777694	65
N0777117	34	N0777438	38, 52	N0777695	65
N0777148	64	N0777439	38, 52	N0777696	65
N0777149	64	N0777441	60	N0777697	65
N0777150	64	N0777442	60	N0777698	65
N0777151	64	N0777443	60	N0777699	65
N0777152	64	N0777444	59, 60	N0777700	65
N0777153	64	N0777445	60	N0777701	65
N0777154	64	N0777446	60	N0777702	65
N0777155	64	N0777447	60	N0777703	65
N0777156	65	N0777460	34, 36, 48	N0777704	65
N0777159	65	N0777462	36, 49	N0777705	65
N0777167	65, 262	N0777463	36, 49, 61	N0777706	65
N0777168	65	N0777464	36, 49, 61	N0777707	34
N0777169	64	N0777465	61	N0777707	41
N0777219	36	N0777466	61	N0777710	91
N0777220	50	N0777476	60	N0777711	60
N0777221	63	N0777484	49	N0777712	35, 49
N0777222	63	N0777485	49	N0777713	35
N0777223	63	N0777486	49	N0777714	35
N0777224	63	N0777487	35	N0777715	43
N0777225	63	N0777488	35	N0777719	89
N0777226	63	N0777489	35	N0777731	39, 41
N0777227	63	N0777490	35	N0777734	35
N0777228	64	N0777494	38	N0777735	35
N0777229	64	N0777495	39	N0777736	35
N0777230	64	N0777496	39	N0777737	35
N0777231	64	N0777497	39	N0777738	35
N0777232	64	N0777508	43	N0777783	47
N0777233	64	N0777509	43	N0777784	47
N0777234	64	N0777510	43	N0777785	47
N0777235	64	N0777511	89, 123	N0777840	43
N0777242	64	N0777512	36, 49	N0777841	43
N0777243	64	N0777513	36, 49	N0777842	43
N0777244	64	N0777514	36, 49	N0777843	43
N0777245	64	N0777518	60	N0777844	38, 39
N0777246	64	N0777521	60	N0777845	36, 49
N0777247	64	N0777547	63	N0777846	36, 49
N0777248	64	N0777561	60	N0777847	36, 49
N0777249	64	N0777565	63	N0777848	61
N0777250	64	N0777568	63	N0777870	27
N0777251	64	N0777599	65, 262	N0777871	27
N0777252	64	N0777602	46	N0777874	60
N0777253	64	N0777603	46	N0777880	43
N0777266	63	N0777604	46	N0777881	46
N0777267	63	N0777605	46	N0777882	46

PART NUMBER INDEX

Part No.	Page	Part No.	Page	Part No.	Page
N0777883	46	N2010245	25	N2025357	19
N0777900	47, 96	N2010246	25	N2025358	19
N0777901	65	N2010247	25	N2025359	19
N0777920	88	N2010250	25	N2025360	19
N0777930	47	N2011074	21	N2025361	19
N0777940	65	N2025300	19	N2025362	19
N0777941	65	N2025301	19	N2025363	19
N0777942	65	N2025302	19	N2025364	19
N0780128	43	N2025303	19	N2025365	19
N0780130	41, 42	N2025304	19	N2025366	19
N0780132	41, 42	N2025305	19	N2061174	158
N0780133	42	N2025306	19	N2350162	154
N0780437	42	N2025307	19	N2350211	154
N0780546	37, 41	N2025308	19	N2351285	155
N0780606	40	N2025309	19	N2410092	298
N0780607	40	N2025310	19	N2410145	298
N0780608	41	N2025311	19	N2410152	298
N0780616	41	N2025312	19	N2410153	299
N0780617	41	N2025313	19	N2410154	299
N0780676	37	N2025314	19	N2410155	299
N0781007	41, 44	N2025315	19	N2410157	298
N0781008	44	N2025316	19	N2410164	298
N0781009	44	N2025317	19	N2410165	298
N0781013	44	N2025318	19	N2410166	298
N0781014	41, 44	N2025319	19	N2410168	298
N0781015	44	N2025320	19	N2410177	298
N0781016	44	N2025321	19	N2410188	298
N0781017	44	N2025322	19	N2410191	298
N0781018	44	N2025323	19	N2410212	299
N0781019	44	N2025324	19	N2410244	299
N0781050	44	N2025325	19	N2410277	298
N0781097	41, 42	N2025326	19	N2410278	298
N0782004	44	N2025327	19	N2410320	299
N0782005	44	N2025328	19	N2410324	298
N0782006	44	N2025329	19	N2410325	298
N0782007	44	N2025330	19	N2410330	299
N0782008	44	N2025331	19	N2410331	298
N0782009	44	N2025332	19	N2410332	298
N0782010	44	N2025333	19	N2410501	298
N1010070	119	N2025334	19	N2410506	298
N1010504	269	N2025335	19	N2410507	298
N1010520	281	N2025336	19	N2410513	298
N1010539	269	N2025337	19	N2410518	298
N1010565	277	N2025338	19	N2410683	298
N1010566	277	N2025339	19	N2410684	298
N1010567	276	N2025340	19	N2410693	298
N1010568	276	N2025341	19	N2410694	298
N1010569	276	N2025342	19	N2410695	298
N1011210	120, 228	N2025343	19	N2410696	298
N1011445	204, 210	N2025344	19	N2410697	298
N1011446	204, 209, 210, 211	N2025345	19	N2410698	298
N1011447	209, 211	N2025346	19	N2411235	299
N1015158	278	N2025347	19	N2411255	299
N1016070	282	N2025348	19	N2411264	299
N1016071	282	N2025349	19	N2411273	298
N1016072	282	N2025350	19	N2411291	299
N1016073	282	N2025351	19	N2411300	299
N1016074	282	N2025352	19	N2411333	298
N1870151	264	N2025353	19	N2411335	298
N1870184	264	N2025354	19	N2411359	299
N1870185	264	N2025355	19	N2411362	299
N1870188	264	N2025356	19	N2411363	299

Part No.	Page	Part No.	Page	Part No.	Page
N2411364	299	N2910511	158	N2920126	154
N2411401	298	N2910512	158	N2920128	154
N2411514	299	N2910515	158	N2920146	155
N2411527	298	N2910765	165	N2920149	155
N2421070	299	N2911127	165	N2920160	154
N2580003	150	N2911170	165	N2920191	126
N2580012	150	N2911196	123	N2920193	126
N2580013	150	N2911197	123	N2922011	155
N2580020	150	N2911198	123	N2922030	154
N2580021	150	N2911199	123	N2922046	155
N2580022	150	N2911200	165	N2922082	155
N2580030	153	N2911201	165	N2922107	154
N2580042	150	N2911202	165	N2922211	154
N2600070	160	N2911203	165	N2925030	155
N2600089	160	N2911205	165	N2925090	154
N2600104	158	N2911206	165	N2925091	154
N2600124	158	N2911210	165	N2930035	167
N2600192	158	N2911211	165	N2930036	167
N2600226	158	N2911212	165	N2930037	167
N2600259	160	N2911220	159	N2930038	167
N2600284	157	N2911221	159, 165	N2930040	167
N2600313	160	N2911224	159, 165	N2930041	167
N2600457	157	N2911235	159	N2930042	167
N2600458	157	N2911236	159	N2930043	167
N2600459	157	N2911239	159	N2930044	167
N2600491	157	N2911240	159	N2930146	167
N2600495	157	N2911241	159	N2930147	167
N2600496	157	N2911244	159	N2930313	165, 168
N2600497	156, 157	N2911245	159	N2930314	167
N2600498	156, 157	N2911249	159	N2930660	164
N2600499	157	N2911250	159	N2930661	164
N2600506	157	N2911251	159	N2930664	164
N2600522	156	N2915006	158	N2930669	164
N2600523	156	N2916016	160	N2930672	164
N2600570	156	N2916019	160	N2930673	164
N2600571	156	N2916052	158	N2930675	164
N2601189	157, 162, 168	N2916056	165	N2930676	164
N2601262	160	N2916059	161	N2930801	168
N2601295	160	N2916085	160	N2930802	168
N2601313	160	N2916200	161, 165	N2931054	166
N2601316	160	N2916201	165	N2931097	167
N2601477	160	N2916202	162	N2931199	165, 212
N2601503	160	N2916210	161, 165	N2931275	160
N2601610	156	N2916211	161	N2932000	164
N2601611	156	N2916212	165	N2932001	164
N2601612	156	N2916213	165	N2932002	164
N2601613	156	N2916214	165	N2936000	165, 212
N2601614	156	N2916215	165	N2936003	164
N2601615	156	N2916216	165	N2936009	165, 212
N2601616	156, 165	N2916217	165	N2936010	165, 212
N2601617	156	N2916218	165	N2936020	164
N2910035	154, 160	N2916219	165	N2936021	164
N2910036	154	N2916222	165	N2936022	164
N2910342	160	N2916223	165	N2936042	164
N2910343	160	N2916224	165	N2936043	164
N2910344	160	N2916260	165	N2936045	164
N2910345	154, 160	N2916261	168	N2936046	164
N2910346	160	N2916262	165, 168	N2936048	164
N2910349	160	N2918536	159	N2936049	164
N2910383	154, 160	N2920070	154	N2936050	164
N2910384	154, 160	N2920117	154	N2936051	165, 212
N2910385	160	N2920124	154	N2936052	165, 212

PART NUMBER INDEX

Part No.	Page	Part No.	Page	Part No.	Page
N2936053.....	165, 212	N3050157.....	14	N3050337.....	14
N2936054.....	165, 212	N3050158.....	14	N3050338.....	14
N2936055.....	165, 212	N3050161.....	14	N3050339.....	14
N2936056.....	161	N3050162.....	14	N3050341.....	14
N2936057.....	161	N3050165.....	14	N3050342.....	14
N2936058.....	161	N3050166.....	14	N3050344.....	14
N2936059.....	161	N3050168.....	15	N3050345.....	14
N2936060.....	161	N3050170.....	14	N3050346.....	14
N2936061.....	161	N3050171.....	15	N3050348.....	15
N2936062.....	161	N3050172.....	15	N3050349.....	14
N2936063.....	161	N3050173.....	15	N3050350.....	14
N2936064.....	161	N3050174.....	15	N3050352.....	14
N2936065.....	161	N3050175.....	15	N3050355.....	14
N2936071.....	161	N3050176.....	15	N3050357.....	14
N2936072.....	161	N3050177.....	15	N3050358.....	14
N2936073.....	161	N3050178.....	15	N3050361.....	14
N2936074.....	161	N3050180.....	15	N3050362.....	14
N2936075.....	161	N3050182.....	15	N3050365.....	14
N2936076.....	161	N3050183.....	15	N3050366.....	14
N2936077.....	161	N3050184.....	15	N3050368.....	15
N2936078.....	161	N3050186.....	15	N3050370.....	14
N2936079.....	161	N3050187.....	15	N3050371.....	15
N2936080.....	161	N3050189.....	15	N3050372.....	15
N2936081.....	161	N3050190.....	15	N3050373.....	15
N2936082.....	161	N3050191.....	15	N3050374.....	15
N2936342.....	165, 212	N3050192.....	15	N3050375.....	15
N3050102.....	15	N3050201.....	15	N3050376.....	15
N3050103.....	14	N3050202.....	15	N3050377.....	15
N3050105.....	14	N3050203.....	15	N3050378.....	15
N3050107.....	14	N3050204.....	15	N3050380.....	15
N3050108.....	14	N3050205.....	15	N3050382.....	15
N3050109.....	14	N3050206.....	15	N3050383.....	15
N3050110.....	14	N3050208.....	15	N3050384.....	15
N3050111.....	14	N3050209.....	15	N3050386.....	15
N3050114.....	14	N3050212.....	15	N3050387.....	15
N3050115.....	14	N3050213.....	15	N3050389.....	15
N3050118.....	14	N3050214.....	15	N3050390.....	15
N3050119.....	14	N3050217.....	15	N3050391.....	15
N3050121.....	14	N3050218.....	15	N3050392.....	15
N3050122.....	14	N3050302.....	15	N3050401.....	15
N3050123.....	14	N3050303.....	14	N3050402.....	15
N3050124.....	14	N3050305.....	14	N3050403.....	15
N3050126.....	14	N3050307.....	14	N3050404.....	15
N3050128.....	14	N3050308.....	14	N3050405.....	15
N3050129.....	14	N3050309.....	14	N3050406.....	15
N3050130.....	14	N3050310.....	14	N3050408.....	15
N3050133.....	14	N3050311.....	14	N3050409.....	15
N3050134.....	14	N3050314.....	14	N3050412.....	15
N3050135.....	14	N3050315.....	14	N3050413.....	15
N3050137.....	14	N3050318.....	14	N3050414.....	15
N3050138.....	14	N3050319.....	14	N3050417.....	15
N3050139.....	14	N3050321.....	14	N3050418.....	15
N3050141.....	14	N3050322.....	14	N3050605.....	16
N3050142.....	14	N3050323.....	14	N3050611.....	16
N3050144.....	14	N3050324.....	14	N3050615.....	16
N3050145.....	14	N3050326.....	14	N3050620.....	16
N3050146.....	14	N3050328.....	14	N3050630.....	16
N3050148.....	15	N3050329.....	14	N3050634.....	16
N3050149.....	14	N3050330.....	14	N3050655.....	16
N3050150.....	14	N3050333.....	14	N3050657.....	16
N3050152.....	14	N3050334.....	14	N3050664.....	16
N3050155.....	14	N3050335.....	14	N3050670.....	16

Part No.	Page	Part No.	Page	Part No.	Page
N3050672	16	N3133019	97	N5190330	294
N3050675	16	N3133021	97	N5190376	293
N3050680	16	N3133022	97	N5190377	293
N3050683	16	N3133023	97	N5190378	293
N3050691	16	N3133024	96	N5190393	293
N3050860	16	N3134000	97	N5190399	293
N3050861	16	N3134002	97	N5190416	293
N3050862	16	N3134004	97	N5190417	293
N3050863	16	N3134005	97	N5190515	294
N3050864	16	N3134007	97	N5190516	294
N3050865	16	N3134009	97	N5190609	293
N3050866	16	N3134010	97	N5190611	293
N3050867	16	N3134011	97	N5190615	293
N3050868	16	N3134012	97	N5190616	295
N3050869	16	N3134013	97	N5190619	293
N3050870	16	N3134014	97	N5190762	292
N3050871	16	N3134015	96	N5190788	290
N3050872	16	N3134064	96	N5190869	295
N3050873	16	N3134072	97	N5191549	293
N3050874	16	N3150131	17	N5191662	293
N3110145	31	N3150188	24	N5191700	293
N3110146	30	N3150230	21	N5191875	294
N3110147	28	N3150232	21, 25	N5200040	295
N3130100	95	N3150303	17	N5200042	295
N3130110	95	N3160143	24, 25	N5200045	295
N3131005	96	N3160144	24, 25	N5201021	295
N3131006	96	N3160146	25	N5201022	295
N3131007	96	N3160152	25	N5201023	295
N3131008	96	N3160153	25	N5201024	295
N3131009	96	N3160154	25	N5202083	294
N3131010	96	N3160156	25	N5203115	290
N3131011	96	N3160157	25	N5316000	86
N3132000	96	N3160158	25	N5316001	86
N3132001	97	N3160159	25	N5316002	86
N3132002	97	N3160179	24	N5316003	86
N3132003	97	N3160182	24	N5316004	86
N3132004	97	N3160188	25	N5316005	86
N3132005	97	N3160189	25	N5316024	86
N3132006	97	N3160192	25	N5316025	86
N3132007	97	N3160193	25	N5330177	297
N3132008	97	N3160194	25	N5330178	297
N3132009	96	N3160505	21, 24, 25	N5330220	296
N3132010	96	N3160506	21	N5330253	296
N3132011	96	N3160511	21, 24, 25	N5330254	297
N3132012	96	N3160546	21	N5330262	297
N3132013	96	N3160809	21	N5330300	296
N3132014	97	N3161040	21	N5330301	296
N3132015	97	N3161240	21	N5330302	296
N3133003	97	N5190172	294	N5330303	296
N3133006	97	N5190180	291	N5330304	296
N3133007	97	N5190196	294	N5330305	296
N3133008	97	N5190197	294	N5330306	296
N3133009	97	N5190202	294	N5330307	296
N3133010	97	N5190203	294	N5330308	296
N3133011	97	N5190264	294	N5330309	296
N3133012	96	N5190276	294	N5330310	296
N3133013	96	N5190279	294	N5330311	296
N3133014	96	N5190280	295	N5330312	296
N3133015	96	N5190282	294	N5330313	296
N3133016	96	N5190283	295	N5330314	296
N3133017	97	N5190284	294	N5330315	296
N3133018	97	N5190285	294	N5330316	296

PART NUMBER INDEX

Part No.	Page	Part No.	Page	Part No.	Page
N5330317	296	N6000637	216	N6101760	212
N5330318	296	N6000981	216	N6102354	214, 215, 225
N5330319	296	N6000986	217	N6103089	214
N5330320	296	N6001204	214	N6103151	214
N5330322	297	N6003057	216	N6103167	214
N5330323	297	N6003066	216	N6103175	214
N5330324	297	N6100016	215	N6103188	214
N5330338	296	N6100038	218	N6103225	214
N5330340	296	N6100047	204	N6103240	212
N5330341	296	N6100048	206	N6103241	212
N5330342	296	N6100102	204, 207, 215	N6103242	212
N5330343	296	N6100153	204, 206, 208, 209	N6103243	212
N5330344	296	N6100157	204	N6107032	198
N5330400	297	N6100158	204	N6107033	198
N5330402	296	N6100159	204, 209	N6107040	198
N5330403	296	N6100161	217	N6107041	198
N5330404	296	N6100194	214, 215	N6107048	198
N5330405	296	N6100228	218	N6107052	198
N5330604	297	N6100243	216	N6107053	198
N5330613	297	N6100244	216	N6107056	198
N5331098	296	N6100245	216	N6107057	198
N5337024	297	N6100253	218	N6107060	198
N5337031	296	N6100256	208	N6107061	198
N5340090	297	N6100260	209	N6107070	198
N5340188	291	N6100261	209	N6107072	198
N5340229	293	N6100264	216	N6107073	198
N5356002	291	N6100275	204, 209	N6107075	198
N5356003	291	N6100289	215	N6107076	198
N5356008	290	N6100331	204	N6107198	199
N5356010	290	N6100357	214	N6107199	199
N5356012	290	N6100361	214	N6107200	199
N5356016	291	N6100364	214	N6107201	199
N5356017	291	N6100430	214	N6107208	198
N5356019	291	N6100447	207	N6107216	198
N5356020	291	N6101034	204, 209	N6107218	198
N5356021	291	N6101048	206	N6107221	198
N5356034	291	N6101050	206	N6107222	198
N5361078	292	N6101052	204, 210	N6107224	198
N5361180	292	N6101085	214	N6107225	198
N5365048	296	N6101182	207	N6107226	198
N5365049	296	N6101251	212	N6107227	198
N5370140	295	N6101252	212	N6107228	198
N5370330	294	N6101253	212	N6107229	198
N5370438	295	N6101297	214	N6107230	198
N5370459	294	N6101345	215	N6107232	198
N5370464	295	N6101358	204	N6120001	200, 207
N5370478	294	N6101372	204, 210	N6120006	214, 220
N5370487	294	N6101374	204	N6120007	206
N5370488	294	N6101375	211	N6120008	206
N5370490	294	N6101378	204	N6120009	205
N5370492	295	N6101380	212	N6120011	217
N5370495	295	N6101390	117, 207, 212	N6120012	220
N5370550	295	N6101412	215	N6120014	217
N5370553	295	N6101474	224	N6120015	220
N5370554	295	N6101482	204, 209	N6120020	214, 220
N5370555	295	N6101539	209, 211	N6120022	205
N5373009	297	N6101696	219	N6120025	206
N5374092	296	N6101702	208	N6120026	217
N5376097	292	N6101703	208, 211	N6120027	220
N5391051	293	N6101705	209	N6120047	219
N5391054	293	N6101747	207, 209	N6120050	205
N5391181	293	N6101751	209	N6120057	219

Part No.	Page	Part No.	Page	Part No.	Page
N6120059	214, 217, 219	N6200150	224, 228	N6520010	206
N6120061	219	N6301054	224	N6520011	206
N6120062	219	N6352030	120	N6520012	205
N6120070	215	N6352031	120	N6520013	205
N6120071	206	N6352032	120	N6520014	209
N6120072	206	N6352033	120	N6520015	209
N6120074	209	N6356471	118	N6520018	214
N6120075	209	N6356472	118	N6520019	214
N6120076	208	N6356473	116	N6520020	217
N6120077	208	N6356474	119	N6520021	217
N6120080	220	N6356475	119	N6520022	220
N6120082	208	N6356477	119	N6520023	220
N6120083	208	N6356478	118	N6520024	218
N6120088	216	N6356479	118	N6520025	218
N6120089	216	N6356558	119	N6520026	219
N6120090	218	N6356559	119	N6520027	219
N6120091	218	N6356560	119	N6520028	216
N6120092	218	N6356561	119	N6520029	216
N6120093	218	N6356562	119	N6520270	202
N6120094	218	N6356563	119	N6520271	202
N6120095	216	N6356564	119	N6520272	202
N6120098	208	N6356566	119	N6520273	202
N6120100	206	N6470012	207, 221, 223	N6621006	121
N6120101	205	N6480080	223	N6621008	121
N6120102	209	N6480081	223	N6621009	121
N6120122	217	N6480082	223	N6621028	204, 206, 207, 208, 209, 213
N6120123	217	N6480130	223	N6621035	121
N6120124	220	N6480132	223	N6621036	121
N6120125	220	N6480140	223	N6621037	121
N6120126	218	N6480141	223	N6621038	121
N6120127	218	N6480142	223	N6700113	228
N6120128	216	N6480143	223	N6700130	228
N6120129	216	N6480144	223	N6701170	228
N6120130	219	N6480145	223	N6710188	225
N6120131	219	N6480146	223	N8102011	48
N6120136	206	N6480147	223	N8120100	54, 55
N6120137	206	N6480148	223	N8120116	54
N6120138	205	N6480149	223	N8120124	52
N6120139	205	N6480151	223	N8120150	52
N6120140	209	N6480153	223	N8120511	57, 58
N6120141	209	N6480154	223	N8120512	57, 58
N6120142	208	N6480360	222	N8120515	48, 58
N6120143	208	N6480361	222	N8120516	48
N6120150	220	N6480362	222	N8120518	58
N6120161	214, 215	N6480380	222	N8120519	58
N6120162	214	N6482024	222	N8120522	78
N6120165	214	N6502000	211	N8120541	78
N6120166	214	N6502001	211	N8120610	58
N6120167	214	N6502002	211	N8120611	58
N6120168	214	N6502003	210	N8121036	34, 48
N6121000	206	N6502004	210	N8121037	48
N6121001	204, 210	N6502005	210	N8121038	48
N6121002	204, 210	N6502006	210	N8121039	48
N6121003	211	N6502009	210	N8121045	49
N6121004	207, 209, 211	N6502010	210	N8121046	49
N6121006	209, 211	N6502011	210	N8121056	49
N6121008	211	N6502012	210	N8121057	49
N6121009	211	N6502013	211	N8121061	49
N6121020	204, 210	N6502014	211	N8121068	88
N6121021	204, 210	N6502015	211	N8121069	47, 88
N6121022	204, 210, 211	N6502016	211	N8121086	57
N6200119	225	N6502017	211	N8122004	56

PART NUMBER INDEX

Part No.	Page	Part No.	Page	Part No.	Page
N8122006	55, 58, 59	N8142098	48	N8145163	62
N8122007	54	N8142300	77	N8145164	62
N8122010	54, 55	N8142301	77	N8145165	62
N8122012	60	N8142302	77	N8145166	62
N8122014	78	N8142303	77	N8145167	62
N8122017	78	N8142304	77	N8145168	62
N8122038	78, 81	N8142305	77	N8145169	62
N8122188	52	N8142306	77	N8145170	62
N8122192	50	N8142307	77	N8145171	62
N8122239	48	N8145000	56	N8145172	62
N8122247	87	N8145003	56	N8145173	62
N8122248	87	N8145011	48	N8145174	62
N8122308	56	N8145012	48	N8145175	62
N8122356	52	N8145013	51	N8145176	62
N8122358	54	N8145013	59	N8145177	62
N8122359	54	N8145014	51, 59	N8145178	62
N8122382	36, 50	N8145015	48, 59	N8145179	62
N8122383	36, 50	N8145016	48, 59	N8145180	62
N8122384	36, 50	N8145017	48, 59	N8145181	62
N8122389	53	N8145018	48, 59	N8145182	62
N8122394	54	N8145022	59	N8145183	62
N8122410	53	N8145050	80, 81	N8145184	62
N8122411	54	N8145051	78, 80	N8145185	62
N8122412	54	N8145052	80	N8145186	62
N8122413	54	N8145053	80	N8145187	62
N8122452	53	N8145054	80	N8145188	62
N8122460	48	N8145055	80	N8145189	62
N8122461	48	N8145056	80	N8145190	62
N8122462	48	N8145057	80	N8145191	62
N8125001	56	N8145058	80	N8145192	62
N8125010	78	N8145059	80	N8145193	62
N8125029	54, 58	N8145060	80	N8145194	62
N8125030	78	N8145061	80	N8145195	62
N8125031	78	N8145099	53	N8145196	62
N8125032	78	N8145101	50	N8145197	62
N8125033	78, 81	N8145106	55	N8145198	62
N8125034	78	N8145119	52	N8145199	62
N8125035	78	N8145120	52	N8145200	62
N8125037	78, 80	N8145121	52	N8145201	62
N8125038	78, 80	N8145122	52	N8145202	62
N8125039	80	N8145135	36, 50	N8145203	62
N8125040	78	N8145136	36, 50	N8145204	62
N8125041	78	N8145137	36, 50	N8145205	62
N8125050	56	N8145138	36, 50	N8145206	62
N8126039	54	N8145145	62	N8145207	62
N8126040	54	N8145146	62	N8145208	62
N8126041	54, 58	N8145147	62	N8145209	62
N8140503	80	N8145148	62	N8145210	62
N8140504	80	N8145149	62	N8145211	62
N8140507	50	N8145150	62	N8145212	62
N8140513	59	N8145151	62	N8145213	62
N8140514	59	N8145152	62	N8145214	62
N8140527	55	N8145153	62	N8145215	62
N8140536	55	N8145154	62	N8145216	62
N8141206	59	N8145155	62	N8145217	62
N8141230	47, 123	N8145156	62	N8145218	62
N8141420	52	N8145157	62	N8145219	62
N8141426	53	N8145158	62	N8145220	62
N8142000	52	N8145159	62	N8145236	36, 50
N8142001	50	N8145160	62	N8145284	78, 80
N8142002	50	N8145161	62	N8145289	80
N8142003	53	N8145162	62	N8145309	53

Part No.	Page	Part No.	Page	Part No.	Page
N8145310	53	N9300119	68	N9300183	68
N8145318	55	N9300120	68	N9300184	68, 75, 76
N8145319	57	N9300121	68	N9300200	72, 76
N8145320	57	N9300122	68	N9300201	72, 76
N8145321	52	N9300123	68	N9300202	72, 76
N8145322	77	N9300124	68	N9300203	72, 76
N8145323	77	N9300125	68	N9300204	72, 76
N8145324	77	N9300126	68, 75, 76	N9300205	76, 79
N8145340	53	N9300127	68	N9300207	68, 76, 79
N8145407	88	N9300128	68	N9300208	76, 79
N9300030	201	N9300129	68, 75	N9300211	76
N9300031	201	N9300130	68	N9300212	76
N9300032	201	N9300131	68, 75	N9300213	76
N9300033	201	N9300132	68, 75	N9300214	76
N9300036	201	N9300133	68	N9300215	76
N9300037	201	N9300134	68	N9300216	76
N9300038	201	N9300135	68	N9300217	76
N9300039	201	N9300136	68, 75	N9300218	75, 79
N9300040	201	N9300137	68	N9300219	75, 79
N9300041	201	N9300138	68	N9300220	75, 79
N9300042	201	N9300139	68	N9300221	75, 79
N9300043	201	N9300140	68	N9300223	76
N9300044	201	N9300141	68, 75, 76	N9300224	79
N9300046	201	N9300142	68	N9300225	80
N9300047	201	N9300143	68	N9300226	75, 76, 79
N9300048	201	N9300144	68	N9300227	75, 76, 79
N9300049	201	N9300145	68	N9300228	75, 79
N9300050	201	N9300146	68	N9300229	75, 79
N9300051	201	N9300147	68	N9300230	72
N9300053	201	N9300148	68	N9300231	71
N9300054	201	N9300148	75	N9300232	71, 81
N9300055	201, 204	N9300149	68	N9300233	71, 81
N9300056	201, 204	N9300150	69	N9300234	71, 81
N9300057	201	N9300151	69	N9300235	71, 75, 81
N9300058	201	N9300152	69, 75, 76	N9300236	71
N9300059	201, 228	N9300153	69, 75	N9300238	71, 81
N9300060	201	N9300154	69	N9300239	71
N9300061	201	N9300155	69	N9300241	77
N9300065	24	N9300156	69	N9300244	73
N9300068	90	N9300157	69	N9300253	74, 81
N9300081	243	N9300158	69	N9300260	73
N9300086	265	N9300160	69	N9300280	72
N9300096	216	N9300161	69, 75	N9300281	72
N9300100	68, 75	N9300162	69, 75	N9300283	70
N9300101	68, 75	N9300163	69	N9300500	117
N9300102	68	N9300165	69, 75	N9300501	117
N9300103	68	N9300166	69	N9300502	117
N9300104	68	N9300167	69, 75	N9300503	117
N9300105	68	N9300168	69	N9300650	117
N9300106	68	N9300169	69	N9300651	30
N9300107	68	N9300170	69	N9300695	117, 168
N9300108	68, 75, 76	N9300171	69	N9300696	117
N9300109	68	N9300172	68	N9300697	117
N9300110	68	N9300173	68	N9300698	117
N9300111	68	N9300174	68	N9300699	117
N9300112	68, 75	N9300175	68	N9300700	117
N9300113	68	N9300176	68	N9300701	117
N9300114	68, 75	N9300177	68	N9300702	117
N9300115	68	N9300178	69	N9300703	115
N9300116	68	N9300179	68, 75, 76	N9300704	115
N9300117	68	N9300180	68	N9300705	115
N9300118	68	N9300181	68	N9300706	115

PART NUMBER INDEX

Part No.	Page	Part No.	Page	Part No.	Page
N9300707	117, 123	N9301712	91	N9302782	204, 207
N9300708	117, 123	N9301714	91	N9302783	204, 207
N9300709	114, 115	N9301715	91	N9302784	116
N9300710	114, 115	N9301720	71	N9302785	120, 121
N9300711	114, 115	N9301721	74, 78	N9302832	228
N9300712	114, 115	N9301735	117	N9302945	115
N9300713	114, 115	N9301736	117	N9302946	78
N9300714	114, 115	N9301945	117	N9302972	213
N9300715	114, 115	N9302130	115	N9302974	243
N9300716	114, 115	N9302134	118	N9302975	119
N9300717	114, 115	N9302136	115	N9302976	119
N9300718	114, 115	N9302139	116	N9302977	119
N9300719	117, 123	N9302140	116	N9302978	119
N9300720	117, 123	N9302141	116	N9302979	119
N9300850	86, 262	N9302149	200	N9302980	119
N9300901	120	N9302197	91	N9302981	119
N9300902	120	N9302199	91	N9303139	229
N9300903	120	N9302202	212	N9303201	237
N9301001	162	N9302203	212	N9303202	237
N9301002	162	N9302210	212	N9303203	237
N9301029	161	N9302211	212	N9303204	237
N9301167	200	N9302212	212	N9303205	239
N9301178	233	N9302213	212	N9303206	239
N9301179	233	N9302222	212	N9303207	239
N9301191	233	N9302224	212	N9303208	239
N9301192	233	N9302226	212	N9303209	239
N9301193	233	N9302230	212	N9303210	239
N9301205	65	N9302231	112	N9303211	239
N9301208	123, 233	N9302235	112	N9303212	239
N9301221	201	N9302555	123, 164	N9303223	171
N9301222	201	N9302560	123, 164, 167	N9303224	171
N9301223	201	N9302561	167	N9303225	236
N9301225	201	N9302562	123, 164, 167	N9303226	236
N9301226	201	N9302563	167	N9303227	236
N9301227	201	N9302564	167	N9303343	213
N9301233	201	N9302565	167	N9303344	204, 213
N9301253	201	N9302600	264	N9303345	204
N9301254	201	N9302603	264	N9303348	118
N9301255	201	N9302605	264	N9303349	118
N9301259	201	N9302609	264	N9303350	119
N9301266	201	N9302610	264	N9303351	118
N9301268	201	N9302611	264	N9303352	118
N9301269	201	N9302612	264	N9303396	147
N9301270	121	N9302614	264	N9303416	116
N9301272	214	N9302615	264	N9303417	116
N9301303	117, 121	N9302619	264	N9303418	115
N9301304	121	N9302620	258	N9303419	116
N9301326	168	N9302622	264	N9303429	243
N9301327	242	N9302640	258	N9303430	131
N9301328	242	N9302642	258	N9303441	116
N9301343	200	N9302643	258	N9303442	116
N9301356	228	N9302650	161, 168	N9303445	29, 31, 73
N9301357	228	N9302677	166	N9303448	200
N9301376	200, 214	N9302678	161	N9303449	116
N9301385	114, 115, 117	N9302679	115	N9303500	130
N9301385	114	N9302680	115, 117	N9303501	130
N9301390	117, 121	N9302681	114	N9303502	130
N9301398	91	N9302682	114	N9303503	130
N9301399	91	N9302684	116, 117	N9303504	130
N9301480	168	N9302685	116, 117	N9303505	130
N9301710	91	N9302686	116, 117	N9303506	130
N9301711	91	N9302780	114, 117	N9303507	129

Part No.	Page	Part No.	Page	Part No.	Page
N9303508	129	N9303572	140	N9303663	135
N9303509	129	N9303573	140	N9303664	135
N9303510	129	N9303574	140	N9303665	135
N9303511	129	N9303575	140	N9303666	143
N9303512	129	N9303576	140	N9303667	143
N9303513	129	N9303577	140	N9303668	143
N9303514	129	N9303578	140	N9303669	143
N9303515	130	N9303598	140	N9303670	143
N9303516	130	N9303599	140	N9303671	143
N9303517	130	N9303600	140	N9303672	143
N9303518	130	N9303601	140	N9303673	143
N9303519	130	N9303602	140	N9303674	142
N9303520	130	N9303603	140	N9303675	142
N9303521	130	N9303604	140	N9303676	142
N9303522	130	N9303605	140	N9303677	142
N9303523	130	N9303606	140	N9303678	142
N9303524	130	N9303607	140	N9303679	142
N9303525	131	N9303613	137	N9303680	142
N9303526	131	N9303614	137	N9303681	142
N9303527	131	N9303615	137	N9303682	142
N9303528	131	N9303616	137	N9303683	142
N9303529	131	N9303617	137	N9303684	142
N9303530	131	N9303618	137	N9303685	142
N9303531	131	N9303619	137	N9303686	142
N9303532	140	N9303625	136	N9303687	142
N9303533	140	N9303626	136	N9303688	143
N9303534	140	N9303627	136	N9303689	143
N9303535	140	N9303628	136	N9303690	143
N9303536	140	N9303629	136	N9303691	143
N9303537	139	N9303630	136	N9303693	143
N9303538	139	N9303631	137	N9303694	143
N9303539	139	N9303632	137	N9303695	143
N9303540	139	N9303633	137	N9303696	143
N9303541	139	N9303634	137	N9303697	143
N9303542	139	N9303635	137	N9303698	143
N9303543	139	N9303636	137	N9303699	143
N9303544	139	N9303637	137	N9303700	143
N9303545	139	N9303638	137	N9303701	143
N9303546	139	N9303639	137	N9303702	143
N9303547	139	N9303640	137	N9303703	143
N9303548	139	N9303641	137	N9303704	143
N9303549	139	N9303642	137	N9303705	143
N9303550	139	N9303643	137	N9303706	143
N9303551	139	N9303644	137	N9303707	143
N9303552	139	N9303645	137	N9303708	143
N9303553	139	N9303646	135	N9303709	143
N9303554	139	N9303647	135	N9303710	143
N9303557	139	N9303648	135	N9303711	142
N9303558	139	N9303649	135	N9303712	142
N9303559	139	N9303650	135	N9303713	142
N9303560	139	N9303651	135	N9303714	142
N9303561	139	N9303652	135	N9303715	142
N9303562	139	N9303653	135	N9303716	142
N9303563	139	N9303654	135	N9303717	142
N9303564	139	N9303655	135	N9303718	138
N9303565	139	N9303656	135	N9303719	138
N9303566	139	N9303657	135	N9303720	138
N9303567	139	N9303658	135	N9303721	138
N9303568	139	N9303659	135	N9303722	143
N9303569	141	N9303660	135	N9303723	143
N9303570	141	N9303661	135	N9303725	69
N9303571	141	N9303662	135	N9303726	68

PART NUMBER INDEX

Part No.	Page	Part No.	Page	Part No.	Page
N9303727	68	N9303785	69	N9303868	143
N9303728	68	N9303786	68	N9303869	133
N9303729	68	N9303787	68	N9303870	133
N9303730	68	N9303788	68	N9303871	133
N9303731	68	N9303789	68	N9303872	142
N9303731	70	N9303790	68	N9303873	143
N9303732	81	N9303791	68	N9303877	142
N9303733	68	N9303792	68	N9303878	143
N9303734	68	N9303793	68	N9303879	134
N9303735	68	N9303794	68	N9303880	134
N9303736	68	N9303795	68	N9303882	142
N9303737	68	N9303796	69	N9303883	143
N9303738	68	N9303797	79	N9303884	137
N9303739	68	N9303798	68	N9303885	137
N9303739	70	N9303799	69	N9303886	141
N9303740	68	N9303800	68	N9303887	132, 133
N9303741	68	N9303801	69	N9303888	132, 133
N9303741	70	N9303802	69	N9303889	132, 133
N9303742	68	N9303803	69	N9303890	132, 133
N9303743	68	N9303804	69	N9303891	132, 133
N9303744	68	N9303805	69	N9303892	132, 133
N9303745	68	N9303806	69	N9303893	142
N9303746	69	N9303807	69	N9303894	143
N9303747	68	N9303808	69	N9303895	134
N9303748	68	N9303809	69	N9303896	134
N9303749	68	N9303810	69	N9303897	134
N9303749	70	N9303811	69	N9303898	134
N9303750	68	N9303812	69	N9303899	134
N9303751	68	N9303813	81	N9303900	134
N9303751	70	N9303814	71, 81	N9303901	142
N9303752	68	N9303816	74, 78	N9303902	143
N9303753	69	N9303818	78	N9303903	132
N9303753	70	N9303819	74	N9303904	132
N9303754	69	N9303821	74, 79	N9303905	132
N9303755	69	N9303822	74, 79	N9303906	132
N9303756	69	N9303823	74, 79	N9303907	132
N9303757	69, 70	N9303824	74, 79	N9303908	132
N9303758	69	N9303825	78	N9303909	142
N9303759	68	N9303826	78	N9303910	143
N9303761	68	N9303827	75	N9303911	132, 133
N9303763	68	N9303828	79	N9303912	132, 133
N9303764	70	N9303829	75	N9303913	132, 133
N9303765	68	N9303830	79	N9303914	134
N9303766	68	N9303831	79	N9303915	134
N9303767	68	N9303832	80	N9303916	134
N9303768	68	N9303833	80	N9303917	132
N9303769	68	N9303834	80	N9303918	132
N9303770	68	N9303835	75	N9303919	132
N9303771	68	N9303836	75	N9303920	133
N9303772	68	N9303837	72	N9303921	133
N9303773	68	N9303838	69	N9303922	133
N9303774	68	N9303839	75	N9303931	130
N9303775	68	N9303840	72, 75	N9303932	130
N9303776	68	N9303840	75	N9303935	136
N9303777	68	N9303841	72	N9303936	136
N9303778	68	N9303842	69	N9303937	136
N9303779	68	N9303843	74, 78	N9303938	143
N9303780	68	N9303844	69	N9303940	71, 137
N9303781	68	N9303847	140	N9303941	71, 137
N9303782	68	N9303848	139	N9303942	71, 137
N9303783	68	N9303851	138	N9303943	71, 143
N9303784	68	N9303867	142	N9303944	71

Part No.	Page	Part No.	Page	Part No.	Page
N9303945	72	N9304153	77	N9304254	69
N9303946	72	N9304154	77	N9304255	69
N9303948	72	N9304155	77	N9304256	69
N9303949	72	N9304156	77	N9304257	69
N9303952	76	N9304157	77	N9304258	69
N9303953	79	N9304158	77	N9304259	69
N9303954	72	N9304159	77	N9304260	69
N9303955	81	N9304160	77	N9304261	69
N9303962	200	N9304168	83	N9304262	69
N9303963	229	N9304200	69	N9304263	69
N9303964	229	N9304201	69	N9304264	69
N9303970	134	N9304202	69	N9304265	69
N9303971	134	N9304203	69	N9304266	69
N9303972	134	N9304204	69	N9304267	70
N9303973	133	N9304205	69	N9304268	70
N9303974	133	N9304206	69	N9304269	70
N9303975	133	N9304207	69	N9304270	70
N9303981	134	N9304208	69	N9304271	70
N9303990	120	N9304209	69	N9304272	70
N9303991	120	N9304210	69	N9304273	70
N9303992	120	N9304211	69	N9304274	70
N9303993	120	N9304212	69	N9304275	70
N9303995	134	N9304213	69	N9304276	70
N9303996	134	N9304214	69	N9304277	70
N9304110	70	N9304215	69	N9304278	70
N9304111	70	N9304216	69	N9304279	70
N9304112	70	N9304217	69	N9304280	70
N9304113	70	N9304218	69	N9304281	70
N9304114	70	N9304219	69	N9304282	70
N9304115	70	N9304220	69	N9304283	70
N9304116	70	N9304221	69	N9304284	70
N9304117	70	N9304222	69	N9304285	70
N9304118	70	N9304223	69	N9304286	70
N9304119	70	N9304224	69	N9304287	70
N9304120	70	N9304225	69	N9304288	70
N9304121	70	N9304226	69	N9304289	70
N9304122	70	N9304227	69	N9304290	70
N9304123	70	N9304228	69	N9304291	70
N9304124	70	N9304229	69	N9304292	70
N9304125	70	N9304230	69	N9304294	70
N9304126	70	N9304231	69	N9304295	70
N9304127	71	N9304232	69	N9304296	70
N9304128	71	N9304233	69	N9304297	70
N9304129	71	N9304234	69	N9304298	70
N9304130	72	N9304235	69	N9304299	70
N9304131	72	N9304236	69	N9304300	70
N9304135	114, 115	N9304237	69	N9304301	70
N9304136	114, 115	N9304238	69	N9304302	70
N9304137	114, 115	N9304239	69	N9304303	70
N9304138	114, 115	N9304240	69	N9304304	70
N9304139	114, 115	N9304241	69	N9304305	70
N9304140	114, 115	N9304242	69	N9304306	70
N9304141	114	N9304243	69	N9304307	70
N9304142	114	N9304244	69	N9304308	70
N9304143	119	N9304245	69	N9304309	70
N9304144	119	N9304247	69	N9304310	70
N9304145	119	N9304248	69	N9304311	70
N9304146	119	N9304249	69	N9304312	70
N9304147	119	N9304250	69	N9304313	70
N9304150	77	N9304251	69	N9304314	70
N9304151	77	N9304252	69	N9304315	70
N9304152	77	N9304253	69	N9304316	70

PART NUMBER INDEX

Part No.	Page	Part No.	Page	Part No.	Page
N9304317	70	N9304611	32	N9305638	177
N9304318	70	N9304612	32	N9305639	177
N9304319	70	N9304613	32	N9305640	177
N9304320	70	N9304614	32	N9305641	177
N9304321	70	N9304615	32	N9305642	177
N9304322	70	N9304616	32	N9305643	177
N9304323	70	N9304617	32	N9305644	177
N9304324	70	N9304618	32	N9305645	177
N9304325	70	N9304619	32	N9305646	177
N9304326	70	N9304620	32	N9305647	177
N9304327	70	N9304621	32	N9305648	177
N9304328	70	N9304622	32	N9305649	177
N9304329	70	N9304623	32	N9305650	177
N9304330	70	N9304624	32	N9305651	177
N9304331	70	N9304625	32	N9305652	177
N9304332	70	N9304626	32	N9305653	177
N9304333	70	N9304627	32	N9305654	177
N9304334	70	N9304628	32	N9305655	179
N9304335	70	N9304629	32	N9305656	179
N9304336	70	N9304630	32	N9305657	179
N9304337	70	N9304631	32	N9305658	179
N9304338	70	N9304632	32	N9305659	179
N9304339	70	N9304633	32	N9305660	179
N9304340	70	N9304634	32	N9305661	179
N9304341	70	N9305600	173	N9305662	179
N9304342	70	N9305601	173	N9305663	179
N9304343	70	N9305602	173	N9305664	179
N9304344	70	N9305603	173	N9305665	179
N9304345	70	N9305604	173	N9305666	179
N9304346	70	N9305605	173	N9305667	179
N9304347	70	N9305606	173	N9305668	179
N9304348	70	N9305607	173	N9305669	179
N9304349	70	N9305608	173	N9305670	179
N9304350	70	N9305609	173	N9305671	179
N9304351	71	N9305610	173	N9305672	179
N9304352	71	N9305611	173	N9305673	179
N9304353	71	N9305612	173	N9305674	179
N9304354	71	N9305613	173	N9305675	179
N9304355	71	N9305614	173	N9305677	181
N9304356	71	N9305615	173	N9305678	181
N9304357	71	N9305616	173	N9305679	181
N9304358	71	N9305617	173	N9305680	181
N9304359	71	N9305618	173	N9305681	181
N9304360	71	N9305619	173	N9305682	181
N9304500	117, 121	N9305620	173	N9305683	181
N9304501	121	N9305621	173	N9305684	181
N9304502	121	N9305622	173	N9305685	181
N9304503	121	N9305623	173	N9305686	182
N9304550	123	N9305624	173	N9305687	182
N9304551	123	N9305625	173	N9305688	182
N9304552	123	N9305626	173	N9305689	182
N9304553	123	N9305627	173	N9305690	182
N9304554	123	N9305628	173	N9305691	182
N9304555	123	N9305629	173	N9305692	182
N9304556	123	N9305630	173	N9305693	182
N9304557	123	N9305631	173, 184	N9305694	182
N9304600	32	N9305632	173	N9305695	182
N9304601	32	N9305633	173	N9305696	182
N9304602	32	N9305634	173	N9305697	182
N9304603	32	N9305635	177	N9305698	179
N9304604	32	N9305636	177	N9306000	200
N9304610	32	N9305637	177	N9306001	200

Part No.	Page	Part No.	Page	Part No.	Page
N9306015	116, 117	N9306107	232	N9306288	170
N9306017	163	N9306108	232	N9306291	240
N9306019	163	N9306109	232	N9306292	240
N9306020	163	N9306110	232	N9306293	240
N9306021	163	N9306111	232	N9306300	162
N9306022	166	N9306112	232	N9306301	162, 168
N9306023	166	N9306113	232	N9306304	241
N9306024	166	N9306114	232	N9306305	241
N9306025	166	N9306116	232	N9306306	241
N9306026	166	N9306117	232	N9306310	196
N9306027	166	N9306118	232	N9306311	196
N9306028	166	N9306127	121	N9306312	196
N9306029	166	N9306142	242, 243	N9306313	196
N9306030	166	N9306200	116	N9306314	196
N9306031	166	N9306201	115	N9306315	196
N9306032	166	N9306203	116	N9306316	196
N9306033	166	N9306205	116	N9306317	196
N9306034	166	N9306206	116	N9306318	196
N9306035	166	N9306207	115	N9306319	196
N9306036	166	N9306208	115	N9306320	196
N9306037	166	N9306210	171	N9306321	196
N9306038	166	N9306211	171	N9306322	196
N9306039	166	N9306212	171	N9306323	196
N9306040	166	N9306213	171	N9306324	196
N9306041	166	N9306214	171	N9306325	196
N9306042	166	N9306216	118	N9306326	196
N9306044	163, 166	N9306218	213	N9306327	196
N9306045	166	N9306219	213	N9306328	196
N9306046	166	N9306220	115	N9306329	196
N9306047	166	N9306223	114	N9306345	27
N9306052	116	N9306223	114, 115	N9306346	27
N9306053	115	N9306224	119	N9306350	240
N9306057	115	N9306225	81	N9306351	240
N9306063	242	N9306228	116	N9306352	240
N9306064	234	N9306229	116	N9306360	116
N9306065	234	N9306231	115	N9306361	116
N9306068	163	N9306232	211	N9306362	116
N9306072	163	N9306233	211	N9306363	116
N9306073	163	N9306234	211	N9306364	116
N9306074	242	N9306235	211	N9306365	116
N9306075	118, 120	N9306236	211	N9306400	105
N9306076	119, 120	N9306237	211	N9306401	106
N9306077	119, 120	N9306240	118	N9306402	106
N9306078	118	N9306241	118	N9306403	108
N9306079	120	N9306242	118	N9306404	106
N9306080	117	N9306247	114	N9306405	108
N9306089	242	N9306251	202	N9306407	105
N9306090	200	N9306262	202	N9306410	106
N9306091	200	N9306264	119	N9306411	105
N9306092	200	N9306265	119, 120	N9306413	105
N9306093	200	N9306266	119	N9306414	106
N9306093	224	N9306267	119	N9306416	105
N9306094	200, 224	N9306268	119	N9306418	108
N9306095	200, 224	N9306269	119	N9306419	105
N9306096	200, 224	N9306269	120	N9306420	105
N9306100	232	N9306270	119	N9306421	106
N9306101	232	N9306271	119	N9306422	104
N9306102	232	N9306277	227	N9306427	108
N9306103	232	N9306278	227	N9306428	108
N9306104	232	N9306285	170	N9306430	104
N9306105	232	N9306286	170	N9306432	105
N9306106	232	N9306287	170	N9306434	106

PART NUMBER INDEX

Part No.	Page	Part No.	Page	Part No.	Page
N9306436	105	N9306539	105	N9306601	109
N9306438	104	N9306540	105	N9306602	109
N9306440	108	N9306541	105	N9306603	109
N9306441	108	N9306542	105	N9306604	109
N9306443	105	N9306543	105	N9306605	109
N9306444	106	N9306544	105	N9306606	109
N9306447	105	N9306545	105	N9306607	109
N9306448	104	N9306546	105	N9306608	109
N9306455	104	N9306547	105	N9306609	109
N9306457	104	N9306548	105	N9306610	109
N9306462	104	N9306549	105	N9306611	109
N9306466	106	N9306550	105	N9306612	109
N9306470	105	N9306551	105	N9306613	109
N9306471	104	N9306552	105	N9306614	109
N9306475	104	N9306553	104	N9306615	109
N9306476	104	N9306554	104	N9306616	109
N9306478	104	N9306555	104	N9306617	109
N9306479	104	N9306556	104	N9306618	109
N9306481	105	N9306557	108	N9306619	109
N9306482	104	N9306558	108	N9306620	109
N9306490	106	N9306559	108	N9306621	109
N9306491	104	N9306560	108	N9306622	109
N9306494	105	N9306561	108	N9306623	109
N9306500	108	N9306562	108	N9306624	109
N9306501	108	N9306563	104	N9306625	109
N9306502	108	N9306564	104	N9306626	109
N9306503	108	N9306565	104	N9306627	109
N9306504	108	N9306566	104	N9306628	109
N9306505	108	N9306567	104	N9306629	109
N9306506	108	N9306568	104	N9306630	109
N9306507	108	N9306569	106	N9306631	109
N9306508	108	N9306570	106	N9306632	109
N9306509	108	N9306571	106	N9306633	104
N9306510	108	N9306572	106	N9306634	104
N9306511	105	N9306573	106	N9306635	108
N9306512	105	N9306574	106	N9306636	108
N9306513	105	N9306575	105	N9306637	108
N9306514	105	N9306576	105	N9306638	108
N9306515	105	N9306577	105	N9306639	108
N9306516	105	N9306578	105	N9306640	104
N9306517	105	N9306579	105	N9306641	106
N9306518	106	N9306580	105	N9306642	104
N9306519	104	N9306581	104	N9306643	106
N9306520	104	N9306582	104	N9306644	106
N9306521	104	N9306583	104	N9306645	106
N9306522	104	N9306584	106	N9306646	108
N9306523	104	N9306585	106	N9306647	108
N9306524	106	N9306586	106	N9306648	108
N9306525	106	N9306587	104	N9306649	105
N9306526	106	N9306588	104	N9306650	107
N9306527	106	N9306589	104	N9306651	107
N9306528	106	N9306590	104	N9306652	107
N9306529	106	N9306591	104	N9306653	107
N9306530	106	N9306592	104	N9306655	107
N9306531	106	N9306593	104	N9306656	107
N9306532	106	N9306594	109	N9306657	107
N9306533	106	N9306595	109	N9306658	107
N9306534	106	N9306596	109	N9306659	107
N9306535	106	N9306597	109	N9306660	107
N9306536	105	N9306598	109	N9306661	107
N9306537	105	N9306599	109	N9306662	107
N9306538	105	N9306600	109	N9306663	107

Part No.	Page	Part No.	Page	Part No.	Page
N9306664	107	N9306821	231	N9306941	111
N9306665	107	N9306822	231	N9307000	227
N9306666	107	N9306823	231	N9307001	227
N9306667	107	N9306824	231	N9307002	227
N9306668	107	N9306825	231	N9307003	227
N9306669	107	N9306826	231	N9307004	227
N9306670	107	N9306827	231	N9307005	225
N9306671	107	N9306828	230	N9307005	227
N9306672	107	N9306829	230	N9307006	227
N9306673	107	N9306830	230	N9307007	227
N9306674	107	N9306831	230	N9307008	227
N9306675	107	N9306832	230	N9307009	227
N9306676	107	N9306833	230	N9307010	227
N9306677	107	N9306834	230	N9307011	227
N9306678	107	N9306835	230	N9307012	227
N9306679	107	N9306836	230	N9307013	227
N9306680	107	N9306837	230	N9307017	115
N9306681	107	N9306838	230	N9307018	115
N9306682	107	N9306839	230	N9307021	116
N9306683	107	N9306840	231	N9307023	116
N9306684	107	N9306841	231	N9307026	227
N9306685	107	N9306842	231	N9307029	243
N9306686	107	N9306843	231	N9307037	227
N9306687	107	N9306844	231	N9307038	227
N9306688	107	N9306845	231	N9307050	227
N9306689	107	N9306846	231	N9307051	227
N9306690	107	N9306847	231	N9307052	227
N9306691	107	N9306848	231	N9307053	227
N9306692	107	N9306849	231	N9307054	227
N9306693	107	N9306850	231	N9307055	227
N9306694	107	N9306851	231	N9307056	227
N9306695	107	N9306852	231	N9307057	227
N9306696	107	N9306853	231	N9307058	227
N9306697	107	N9306854	231	N9307059	227
N9306698	107	N9306855	231	N9307060	227
N9306699	107	N9306856	231	N9307061	227
N9306700	107	N9306857	231	N9307062	227
N9306713	105	N9306900	111	N9307063	227
N9306755	89	N9306901	111	N9307064	227
N9306757	89	N9306902	111	N9307065	227
N9306758	89	N9306908	111	N9307066	227
N9306800	230	N9306909	111	N9307075	238
N9306801	230	N9306910	111	N9307076	238
N9306802	230	N9306911	111	N9307077	238
N9306803	230	N9306912	111	N9307078	238
N9306804	230	N9306913	111	N9307079	238
N9306805	230	N9306914	111	N9307080	238
N9306806	230	N9306920	111	N9307081	238
N9306807	230	N9306921	111	N9307082	238
N9306808	230	N9306922	111	N9307083	238
N9306809	230	N9306923	111	N9307085	243
N9306810	230	N9306924	111	N9307086	243
N9306811	230	N9306925	111	N9307093	235
N9306812	230	N9306926	111	N9307094	235
N9306813	230	N9306927	111	N9307095	235
N9306814	231	N9306933	111	N9307096	235
N9306815	231	N9306935	111	N9307097	234, 235
N9306816	231	N9306936	111	N9307098	235
N9306817	231	N9306937	111	N9307103	74
N9306818	231	N9306938	111	N9307104	75
N9306819	231	N9306939	111	N9307105	75
N9306820	231	N9306940	111	N9307106	75

PART NUMBER INDEX

Part No.	Page	Part No.	Page	Part No.	Page
N9307107	75	N9308017	93	N9308205	82
N9307108	76	N9308018	94	N9308206	82
N9307109	76	N9308019	92	N9308207	82
N9307110	76	N9308020	94	N9308208	82
N9307111	74	N9308021	94	N9308209	82
N9307112	74	N9308022	94	N9308210	82
N9307113	71	N9308023	94	N9308211	82
N9307114	71	N9308024	93	N9308212	82
N9307115	71	N9308025	93	N9308213	82
N9307116	71	N9308027	93	N9308214	82
N9307117	70	N9308029	94	N9308215	82
N9307118	74	N9308030	93	N9308216	82
N9307119	74	N9308031	93	N9308217	82
N9307504	89	N9308032	93	N9308218	82
N9307509	89	N9308033	93	N9308219	82
N9307511	89	N9308034	93	N9308220	82
N9307512	89	N9308035	109	N9308221	82
N9307515	89	N9308036	94	N9308222	82
N9307519	89	N9308037	93	N9308223	82
N9307521	89	N9308041	94	N9308224	82
N9307522	89	N9308042	94	N9308225	82
N9307522	89	N9308044	94	N9308226	82
N9307523	89	N9308045	94	N9308227	82
N9307738	74	N9308048	93	N9308228	82
N9307740	86	N9308049	93	N9308229	82
N9307741	72	N9308050	93	N9308230	82
N9307760	89	N9308056	93	N9308231	82
N9307800	162	N9308058	93	N9308232	82
N9307801	115	N9308059	93	N9308233	82
N9307802	115	N9308060	93	N9308234	82
N9307805	74	N9308063	109	N9308235	82
N9307806	74	N9308065	94	N9308236	82
N9307807	74	N9308066	93	N9308237	82
N9307808	74	N9308067	94	N9308238	82
N9307809	76	N9308068	94	N9308239	83
N9307810	76	N9308069	94	N9308241	83
N9307820	168	N9308070	94	N9308242	83
N9307822	168	N9308073	94	N9308243	83
N9307823	116	N9308150	89	N9308245	83
N9307830	28	N9308160	84	N9308247	83
N9307831	28	N9308161	84	N9308248	83
N9307832	28	N9308162	84	N9308249	83
N9307833	28	N9308163	84	N9308251	83
N9307834	31	N9308164	84	N9308252	83
N9307835	31	N9308165	84	N9308255	82
N9308000	94	N9308166	84	N9308258	83
N9308001	94	N9308167	84	N9308259	83
N9308002	93	N9308168	84	N9308262	84
N9308003	93	N9308169	84	N9308263	84
N9308004	92	N9308170	84	N9308264	84
N9308005	92	N9308173	85	N9308265	84
N9308006	92	N9308174	85	N9308266	84
N9308007	92	N9308176	85	N9308267	84
N9308008	93	N9308177	85	N9308268	84
N9308009	94	N9308178	85	N9308269	84
N9308010	92	N9308181	85	N9308270	84
N9308011	93	N9308182	85	N9308271	84
N9308012	92	N9308200	82	N9308272	84
N9308013	93	N9308201	82	N9308273	84
N9308014	92	N9308202	82	N9308274	84
N9308015	93	N9308203	82	N9308278	85
N9308016	93	N9308204	82	N9308279	85

Part No.	Page	Part No.	Page	Part No.	Page
N9308280	85	N9308352	86, 262	N9308427	125
N9308281	85	N9308354	86, 262	N9308428	125
N9308282	85	N9308355	83	N9308429	125
N9308283	85	N9308356	83	N9308430	125
N9308284	85	N9308357	83	N9308431	125
N9308285	85	N9308358	83	N9308432	125
N9308286	85	N9308359	83	N9308433	125
N9308287	85	N9308360	83	N9308434	125
N9308288	85	N9308361	83	N9308435	125
N9308289	85	N9308362	83	N9308450	125
N9308290	86	N9308363	83	N9308451	125
N9308291	86	N9308364	83	N9308452	125
N9308292	86	N9308365	83	N9308453	125
N9308293	86	N9308366	83	N9308454	125
N9308294	86	N9308367	83	N9308455	125
N9308295	86	N9308368	83	N9308456	125
N9308296	86	N9308369	83	N9308457	125
N9308297	84	N9308370	83	N9308458	125
N9308300	83	N9308371	83	N9308459	125
N9308301	83	N9308372	83	N9308460	125
N9308302	83	N9308373	83	N9308461	125
N9308303	83	N9308374	83	N9308462	125
N9308304	83	N9308375	86	N9308463	125
N9308305	83	N9308376	86, 262	N9308464	125
N9308306	83	N9308377	86	N9308465	125
N9308307	83	N9308378	84	N9308466	125
N9308308	83	N9308380	86, 262	N9308467	125
N9308309	83	N9308381	94	N9308468	125
N9308310	83	N9308382	94	N9308469	125
N9308311	83	N9308390	85	N9308470	125
N9308312	83	N9308391	85	N9308471	125
N9308313	83	N9308392	85	N9308472	125
N9308314	86	N9308393	85	N9308473	125
N9308315	83	N9308394	85	N9308474	125
N9308316	83	N9308395	85	N9308475	125
N9308317	83	N9308400	125	N9308476	125
N9308318	83	N9308401	125	N9308477	125
N9308319	83	N9308402	125	N9308478	125
N9308320	83	N9308403	125	N9308479	125
N9308321	83	N9308404	125	N9308480	125
N9308322	82	N9308405	125	N9308481	125
N9308323	82	N9308406	125	N9308482	125
N9308324	83	N9308407	125	N9308483	125
N9308325	83	N9308408	125	N9308484	125
N9308326	83	N9308409	125	N9308485	125
N9308327	83	N9308410	125	N9308486	125
N9308328	83	N9308411	125	N9308487	125
N9308329	83	N9308412	125	N9308488	125
N9308330	83	N9308413	125	N9308489	125
N9308331	109	N9308414	125	N9308490	125
N9308332	109	N9308415	125	N9308491	125
N9308333	83	N9308416	125	N9308492	125
N9308334	83	N9308417	125	N9308493	125
N9308340	93	N9308418	125	N9308494	125
N9308341	85	N9308419	125	N9308495	125
N9308342	85	N9308420	125	N9308496	125
N9308343	85	N9308421	125	N9308497	125
N9308344	85	N9308422	125	N9308498	125
N9308345	85	N9308423	125	N9308499	125
N9308346	85	N9308424	125	N9308500	125
N9308350	86, 262	N9308425	125	N9308501	125
N9308351	86, 262	N9308426	125	N9308502	125

PART NUMBER INDEX

Part No.	Page	Part No.	Page	Part No.	Page
N9308503	125	N9308702	94	N9315067	189
N9308504	125	N9308703	94	N9315068	189
N9308505	125	N9308704	93	N9315069	189
N9308506	125	N9308705	93	N9315070	189
N9308507	125	N9308706	93	N9315071	190
N9308508	125	N9308707	94	N9315072	190
N9308509	125	N9308708	93	N9315073	190
N9308510	125	N9308709	92	N9315074	190
N9308511	125	N9308710	92	N9315075	190
N9308512	125	N9308711	93	N9315076	190
N9308513	125	N9308712	93	N9315499	176
N9308514	125	N9308713	93	N9316001	176
N9308515	125	N9308714	85	N9316002	176
N9308516	125	N9308715	85	N9316003	176
N9308517	125	N9308716	85	N9316004	176
N9308518	125	N9308717	85	N9316005	176
N9308519	125	N9308718	85	N9316006	176
N9308520	125	N9308719	85	N9316007	176
N9308521	125	N9308720	85	N9316008	176
N9308522	125	N9308721	85	N9316009	176
N9308523	125	N9308722	85	N9316010	176
N9308524	125	N9308723	85	N9316011	176
N9308525	125	N9308724	85	N9316012	176
N9308526	125	N9308725	86	N9316013	176
N9308527	125	N9308726	85	N9316014	176
N9308528	125	N9308900	262	N9316015	194
N9308529	125	N9308901	262	N9316016	176
N9308530	125	N9308904	262	N9316017	176
N9308531	125	N9309004	33	N9316018	176
N9308532	125	N9309006	33	N9316019	176
N9308533	125	N9309007	33	N9316020	176
N9308534	125	N9309008	33	N9316021	176
N9308535	159	N9309009	33	N9316022	176
N9308540	86	N9309010	33	N9316023	176
N9308541	71	N9309011	33	N9316024	176
N9308542	71	N9309012	33	N9316025	176
N9308543	71	N9309013	33	N9316026	176
N9308552	83	N9309017	33	N9316027	176
N9308554	85	N9309019	33	N9316028	176
N9308555	85	N9309021	33	N9316029	176
N9308571	81	N9309024	33	N9316030	176
N9308573	169	N9309025	33	N9316031	176
N9308574	169	N9309026	33	N9316032	176
N9308575	169	N9309027	33	N9316034	176
N9308576	169	N9309028	33	N9316035	176
N9308577	234	N9309029	33	N9316036	176
N9308578	234	N9309030	33	N9316037	176
N9308579	234	N9309031	33	N9316038	176
N9308580	234	N9309032	33	N9316039	176
N9308581	235	N9309033	33	N9316040	176
N9308582	235	N9309034	33	N9316041	176
N9308583	235	N9309035	33	N9316042	176
N9308584	235	N9309036	33	N9316043	176
N9308585	235	N9309066	33	N9316044	176
N9308587	169	N9309103	33	N9316045	176
N9308588	169	N9309108	33	N9316046	176
N9308589	169	N9309109	33	N9316047	176
N9308590	169	N9309110	33	N9316048	176
N9308591	74, 80	N9309130	227	N9316049	176
N9308592	74, 80	N9309160	226	N9316050	176
N9308700	94	N9309161	226	N9316051	176
N9308701	94	N9311570	194	N9316052	176

Part No.	Page	Part No.	Page	Part No.	Page
N9316053	176	N9316123	180	N9316203	189
N9316054	176	N9316124	180	N9316204	189
N9316056	176	N9316125	180	N9316205	189
N9316057	176	N9316126	180	N9316206	189
N9316058	176	N9316127	180	N9316207	189
N9316061	176	N9316128	180	N9316208	189
N9316062	176	N9316129	180	N9316209	189
N9316063	176	N9316130	180	N9316210	185
N9316064	176	N9316131	180	N9316212	185
N9316065	194	N9316132	180	N9316213	185
N9316066	178	N9316133	180	N9316214	185
N9316067	178	N9316134	180	N9316215	185
N9316068	178	N9316135	180	N9316216	185
N9316069	178	N9316136	180	N9316217	185
N9316071	178	N9316137	180	N9316218	185
N9316072	178	N9316138	180	N9316219	185
N9316073	178	N9316139	180	N9316220	185
N9316074	178	N9316140	180	N9316221	185
N9316075	178	N9316141	180	N9316222	185
N9316076	117, 178	N9316142	180	N9316223	185
N9316077	178	N9316143	180	N9316224	185
N9316078	178	N9316144	182	N9316225	185
N9316079	178	N9316145	182	N9316226	185
N9316080	178	N9316146	182	N9316227	185
N9316081	178	N9316147	182	N9316228	186
N9316082	178	N9316148	182	N9316229	186
N9316083	178	N9316149	182	N9316230	186
N9316085	178	N9316150	182	N9316231	186
N9316086	178	N9316151	182	N9316232	186
N9316087	178	N9316152	182	N9316234	186
N9316089	178	N9316153	182	N9316235	186
N9316090	178	N9316172	184	N9316236	186
N9316091	178	N9316173	184	N9316237	186
N9316092	178	N9316174	184	N9316238	186
N9316093	178	N9316175	184	N9316239	186
N9316094	178	N9316176	184	N9316240	186
N9316095	178	N9316177	184	N9316242	186
N9316096	178	N9316178	184	N9316243	186
N9316097	178	N9316179	184	N9316244	186
N9316098	178	N9316180	184	N9316245	186
N9316099	178	N9316182	184	N9316246	186
N9316100	178	N9316183	184	N9316247	186
N9316101	178	N9316184	184	N9316248	186
N9316102	178	N9316185	184	N9316249	186
N9316103	178	N9316186	184	N9316250	186
N9316104	178	N9316187	184	N9316251	186
N9316105	178	N9316188	193	N9316252	186
N9316108	178	N9316189	193	N9316253	186
N9316109	178	N9316189	193	N9316254	186
N9316110	178	N9316190	193	N9316255	186
N9316111	178	N9316191	193	N9316256	186
N9316112	178	N9316192	193	N9316257	186
N9316113	180	N9316193	193	N9316258	186
N9316114	180	N9316194	193	N9316259	186
N9316115	180	N9316195	193	N9316261	193
N9316116	180	N9316196	193	N9316262	193
N9316117	180	N9316197	193	N9316263	180
N9316118	180	N9316198	193	N9316264	180
N9316119	180	N9316199	193	N9316265	180
N9316120	180	N9316200	189	N9316266	180
N9316121	180	N9316201	189	N9316267	180
N9316122	180	N9316202	189	N9316268	177

PART NUMBER INDEX

Part No.	Page	Part No.	Page	Part No.	Page
N9316269	177	N9316404	187	N9316551	188
N9316270	177	N9316405	187	N9316552	188
N9316271	177	N9316406	187	N9316553	188
N9316272	178	N9316407	187	N9316554	188
N9316273	178	N9316408	187	N9316555	188
N9316275	178	N9316409	187	N9316556	188
N9316276	179	N9316410	187	N9316557	188
N9316277	179	N9316411	187	N9316558	188
N9316279	179	N9316412	187	N9316559	188
N9316280	179	N9316413	187	N9316560	188
N9316282	179	N9316416	187	N9316561	188
N9316283	179	N9316417	187	N9316563	188
N9316284	179	N9316418	187	N9316564	188
N9316286	179	N9316419	187	N9316565	188
N9316287	179	N9316420	187	N9316566	188
N9316289	179	N9316421	187	N9316567	188
N9316290	179	N9316422	187	N9316568	188
N9316291	179	N9316423	187	N9316569	188
N9316293	179	N9316425	187	N9316570	188
N9316294	179	N9316426	187	N9316571	188
N9316295	179	N9316427	187	N9316572	194
N9316297	179	N9316428	187	N9316575	190
N9316298	179	N9316429	187	N9316580	176
N9316299	179	N9316478	187	N9316596	176
N9316300	179	N9316480	191	N9316607	228
N9316301	179	N9316481	191	N9316608	228
N9316302	179	N9316483	191	N9316616	183
N9316303	179	N9316484	191	N9316617	183
N9316304	195	N9316485	191	N9316618	183
N9316305	195	N9316487	191	N9316619	183
N9316319	193	N9316488	191	N9316620	183
N9316345	193	N9316489	191	N9316621	183
N9316346	193	N9316490	191	N9316622	183
N9316347	193	N9316491	191	N9316623	183
N9316348	193	N9316492	191	N9316624	183
N9316349	193	N9316493	191	N9316625	183
N9316350	193	N9316494	191	N9316626	183
N9316351	194	N9316495	191	N9316627	183
N9316352	194	N9316496	191	N9316628	183
N9316353	194	N9316497	191	N9316629	183
N9316354	194	N9316498	193	N9316630	183
N9316355	194	N9316506	194	N9316631	183
N9316356	194	N9316507	194	N9316632	183
N9316357	194	N9316508	194	N9316633	183
N9316358	194	N9316520	194	N9316634	183
N9316359	195	N9316521	194	N9316635	183
N9316360	195	N9316534	181	N9316636	183
N9316361	195	N9316535	181	N9316637	183
N9316374	178	N9316536	181	N9316638	183
N9316386	194	N9316537	181	N9316639	183
N9316387	194	N9316538	181	N9316640	183
N9316388	192	N9316539	181	N9316641	183
N9316389	192	N9316540	181	N9316642	183
N9316390	192	N9316541	181	N9316643	183
N9316391	192	N9316542	181	N9316644	183
N9316392	192	N9316544	195	N9316645	183
N9316393	192	N9316545	193, 195	N9316646	183
N9316399	187	N9316546	195	N9316647	183
N9316400	187	N9316547	188	N9316648	183
N9316401	187	N9316548	188	N9316649	183
N9316402	187	N9316549	188	N9316650	191
N9316403	187	N9316550	188	N9316651	191

Part No.	Page	Part No.	Page	Part No.	Page
N9316652	191	NR004030	198	WE014081	52
N9316653	191	NR004031	198	WE014777	56
N9316654	191	NR004038	198	WE015554	55
N9316655	191	NR004040	198	WE016558	87
N9316656	191	NR004041	198	WE017142	57
N9316657	191	NR004043	198	WE018034	56, 58
N9316658	191	NR004044	198	WE021137	57, 58
N9316659	191	NR004045	198	WE021140	57, 58
N9316661	192	NR004046	198	WE021816	55, 58, 59
N9316662	192	NR004083	198	WE023948	54, 58, 59
N9316663	192	NR004086	198	WE023951	54
N9316664	192	NR004087	198	WE024371	48
N9316665	192	NR004229	198	WE024372	48
N9316666	192	NX598006	160, 161, 168	WE024375	48, 59
N9316667	192	PELA 9011	269	WE025221	51, 58
N9316668	192	PELA 9013	269	WE027005	54
N9316669	192	PELA 9018	269	WE027030	54
N9316670	192	PELA 9019	269	WE027484	57
N9316671	192	PELA 9058	269	WE027802	57, 58
N9316672	192	PELA1003	282	WE027803	57, 58
N9316673	178	PELA1005	282	WE029011	56
N9316674	178	PELA1006	282	ZECVSTDDADMWD	126
N9316675	178	PELA1008	282	ZECVSTDVWD	126
N9316676	178	PELA1013	282	ZECVSTDWPDADMWD	126
N9316677	178	PELA1014	282	ZECVSTDWPVWD	126
N9316678	178	PELA1015	282	ZG196985000	122
N9316679	178	PELA9038	280	ZG2421A	122
N9316680	178	PELA9039	280	ZULECVSTDDADMWD	126
N9316681	178	PELA9040	279, 280	ZULECVSTDVWD	126
N9316682	178	PELA9057	280	ZULECVSTDWPDADMWD	126
N9316684	178	W1007468	55	ZULECVSTDWPVWD	126
N9316685	176	W1008384	55		
N9316686	176	W1008572	55		
N9316691	176	W1008573	55		
N9316692	176	W1010620	56		
N9318482	191	W1012406	54, 55, 58, 59		
N9326141	186	W1012406	54		
N9331028	245	W1012408	55		
N9331030	245	W1012409	55		
N9331031	245	W1013195	56		
N9331032	245	W1013266	54		
N9331033	245	W1013361	56		
N9331036	245	W1013545	54, 55		
N9331037	245	W1017871	56		
N9331038	245	W1020668	55		
N9331041	244	W1020672	55		
N9331042	244	W1020996	58		
N9331043	244	W1026356	57, 59		
N9331044	245	W1026907	57, 59		
N9331045	245	W1033612	57, 59		
N9331046	245	W1033614	57, 59		
N9331047	244	W1033995	57, 59		
N9331048	244	W1034694	57		
N9331060	245	W1036712	59, 91		
N9331061	245	W1036713	59, 91		
N9331062	245	W1037267	59		
N9331063	245	W1037485	55		
N9331064	245	W1040148	57, 59		
N9334010	152	W5005586	59		
N9336181	184	WE012411	55		
NR002500	198	WE013060	52, 54		
NR002503	198	We014034	58		

Atomic Spectroscopy - Instrument Overview	12-13
AAAnalyst 200/400 Atomic Absorption Spectrometers	12
NexION 350 ICP-MS Spectrometers	13
Optima 8x00 ICP-OES Spectrometers.....	13
PinAAcle 900 Atomic Absorption Spectrometers	12
Autosampler Cups and Supplies	26
Autosampler Cups.....	26
Autosampler Trays.....	26
Pliers	26
Reagent Containers.....	26
Sampling Capillaries	26
Burner System Components.....	20-21
Burner Heads	20
Burner System Components	21
Compressors	27
Graphite Furnace Tubes and Supplies	28-32
HGA Graphite Tubes and Supplies	30-32
Contact Cylinders	31
Graphite Tubes	30-32
Matrix Modifiers	31
THGA Graphite Tubes and Supplies	28-29
Accessories and Spare Parts	29
Contact Cylinders	29
Graphite Tubes	28-29
Instrument Mirror	29
Matrix Modifiers	29
Lamps.....	14-19
1.5" Atomax Hollow Cathode Lamps	18-19
2" Lumina Hollow Cathode Lamps.....	14-15
Lumina Multi-Element Hollow Cathode Lamps.....	15
Lumina Single-Element Hollow Cathode Lamps.....	14-15
Electrodeless Discharge Lamps.....	16-17
EDL Driver Assemblies.....	17
EDL Driver Components.....	17
Electrodeless Discharge Lamps	16
Mercury Analyzer Supplies	33
Nebulizers, Assemblies and Spares	22-25
Nebulizer Accessories	24-25
Nebulizers	22-23

Autosampler Supplies.....	63-65	Sample Preparation Blocks.....	92-94
Accessories.....	64	Sample Preparation Blocks and Controllers.....	92
Autosampler Probe Assemblies.....	63	Automatic Shut-Off System.....	94
Cetac.....	63	Digi FILTERS.....	93
ESI.....	63	SPB Hoods.....	94
PerkinElmer.....	63	Start Up Kits.....	93
Used Oil Autosampler Probe.....	63	Temperature Probes.....	94
Autosampler Tubes.....	65	Tubes, Caps & Watch Glasses.....	93
Cooling Systems.....	87	Standards.....	68-86
Chiller Coolant Mix.....	87	Inorganic Aqueous Standards.....	68-81
Chillers/Recirculating Water Cooling Systems.....	87	AA Test Mix.....	73
Coolant Fluid.....	87	Contract Required Detection Limits (CRDL).....	80
Heat Exchanger System.....	87	Environmental Method Sets.....	74-76
Flow Injection System.....	66-67	GFAAS Mixed Standard.....	73
Adapters and Connectors.....	66	Initial Calibration Verification Standards.....	79
Mixing/Separation Assembly.....	67	Instrument Calibration Standards.....	78
Flow Injection Furnace Supplies.....	67	Instrument Calibration Standards for CLP.....	79
Gas/Liquid Separator.....	67	Instrument Check Standards.....	79
Mixing Block.....	67	Instrument Setup Solutions.....	78
Sample Loops.....	67	Interference Check Standards.....	79
Tool, Screw Connectors.....	67	Internal Standard Solutions.....	80
Tubing.....	67	Isotope Standard.....	81
Internal Standard Kits.....	61	Matrix Blanks.....	81
Internal Standard Kits.....	61	Matrix Modifiers for Graphite Furnace AA.....	73
HF-Resistant Internal Standard Kit.....	61	Mixed Calibration Standards.....	72
Non HF-Resistant Internal Standard Kit.....	61	Multi-Element Standards.....	71-72
Laboratory Products.....	90-91	Performance Verification Standards.....	80
Blower and Vent Assembly.....	90	Quality Control Standards.....	72
Dryers, Filters, and Replacement Parts.....	91	Reagents.....	73
Flashback Arrestor.....	90	Single-Element Standards.....	68-70
Hose Assemblies.....	90	SmartTune Standards.....	78
Instrument Filters.....	91	Spike Sample Standards.....	72
Polyscience Replacement Air Filters.....	91	Toxicity Characteristic Leachate Procedure	
Regulators.....	90	(TCLP) Standard.....	77
Microwave Sample Preparation.....	95-97	Universal Data Acquisition Standards Kit.....	81
Titan MPS Systems.....	95	USP and ICH Standards.....	77
Titan MPS System Accessories.....	96-97	Wash Standards.....	81
Titan MPS Consumables.....	96-97	Water Pollutant Standards.....	76
Power Conditioners and UPS Systems.....	89	Wear Metal Metallo-Organic Standards.....	82-86
Power Conditioners.....	89	Biodiesel Standards.....	85
Uninterruptable Power Supply Systems.....	89	Fuel Dilution Oils.....	84
Pump Tubing.....	60-62	Internal Standards.....	83
Three-Stop Peristaltic Pump Tubing.....	62	Karl Fischer Standards.....	85
Two-Stop Peristaltic Pump Tubing.....	60, 62	Matrix Oils and Solvents.....	84
Noise Enclosures.....	88	Metal Additive Standards.....	83
		OilExpress Standards.....	86
		Proficiency Testing Standards.....	86
		Single-Element Standards.....	82
		Soot Content Standards.....	85
		V-21 Wear Metal Standards.....	83
		V-23 Wear Metal Standards.....	83
		Viscosity Reference Standards.....	86
		V-Solv.....	84
		Trays and Racks.....	64
		Cetac Autosampler Supplies.....	64
		Racks.....	64
		ESI Autosampler Supplies.....	64
		Racks and Rack Covers.....	64
		PerkinElmer Sample Trays.....	64
		Trays and Supplies.....	64

Crimping Tools and Vial Accessories..... 121

QuEChERS Dispersive SPE..... 110-111

Solid Phase Extraction (SPE)..... 101-109

Solid Phase Extraction (SPE) Application Packs	109
Solid Phase Extraction (SPE) Columns and Well Plates ...	101-108
300 Å C4 Columns	104
Amino Columns and Well Plates	106
C18 Columns and Well Plates	104
Cyano Columns	106
Florisol (Pesticide Grade) Columns	105
Florisol Columns	105
LCC Columns	106
Mixed Mode (1) Columns and Well Plates	105
Mixed Mode (2) Columns	105
Mixed Mode (3) Columns	105
Phenyl Columns and Well Plates	106
Polyamine Columns	106
REC18 Columns and Well Plates	104
Silica Columns and Cartridges.....	106
Strong Anion Exchange Columns and Well Plates.....	104
Strong Cation Exchange Columns and Well Plates.....	105
Super-Poly Environmental Columns.....	108
Super-Poly Extra Wide Particle 1200 m ² /g Columns and Well Plates	108
Super-Poly Extreme Capacity 1500 m ² /g Columns and Well Plates	108
Super-Poly HLB Columns and Well Plates	107
Super-Poly Hydrophilic Columns.....	108
Super-Poly Lipophilic Columns	108
Weak Cation Exchange Columns and Well Plates.....	105
Solid Phase Extraction (SPE) Selection Kits.....	109

Syringe Filters..... 100

Nylon Filters	100
PTFE (Hydrophobic) Filters.....	100
PTFE (Hydrophilic) Filters	100
PVDF Filters	100

Syringes 112

Vials, Caps and Septa..... 113-120

Autosampler Vials, Caps and Septa	114-117
2 mL Vials (12 x 32 mm)	114
Caps and Septa	116
Inserts for 2 mL Vials.....	115
Kits - Convenience.....	117
Kits - Starter	117
Vials with fused inserts (12 x 32 mm).....	115
Headspace Vials, Caps and Septa	
Caps and Septa	119
Kits - Convenience.....	120
Kits - Starter	120
Vials	118

Autosampler Parts and Accessories.....	228	Detectors	214-220																																																																																																																																																																																												
Calibration Gas Blends - Arnel Analyzers.....	199	Electron Capture Detector (ECD).....	217																																																																																																																																																																																												
Columns.....	172-198	Flame Ionization Detector (FID)	214-215																																																																																																																																																																																												
Capillary Columns - General Purpose.....	176-188, 196, 198	Flame Photometric Detector (FPD)	216																																																																																																																																																																																												
Arnel Replacement Columns.....	198	Nitrogen Phosphorous Detector (NPD)	218																																																																																																																																																																																												
Elite-1	176	Photoionization Detector (PID).....	219																																																																																																																																																																																												
Elite-1301	185	Thermal Conductivity Detector (TCD).....	220	Elite-17	180	Ferrules and Connectors.....	200	Elite-1701	186	Fittings.....	201	Elite-17MS	181	Gas Management.....	229-243	Elite-17MS+.....	181	Compressors	240	Elite-1HT.....	177	Filters	229-233	Elite-1MS.....	177	Flow Meter.....	243	Elite-200.....	183	Generators - Hydrogen.....	234-237	Elite-225.....	184	Generators - Zero Air.....	238-239	Elite-35.....	182	Leak Detector.....	242	Elite-35MS.....	182	Regulators.....	241	Elite-5.....	178	Injection Port Septum.....	213	Elite-5 Amine.....	178	Injectors	204-209	Elite-5HT.....	178	Liners.....	210-211	Elite-5MS.....	179	Marathon Filament	221	Elite-5MS II	179	Organic Standards	244-245	Elite-624.....	189	SMARTSource	222-223	Elite-624 MS.....	189	Syringes	212	Elite-WAX.....	187	Swafer.....	202-203	Elite-WAX ETR	188	Thermal Desorber Consumables and Accessories....	224-227	Velocity-1	196	Conditioning Oven.....	226	Velocity-5	196	Kits and Accessories	225	Velocity-WAX.....	196	Packed Traps	224	Capillary Columns - Integrated Guard Columns	173	Tubes	227	Capillary Columns - Specialty Phases	190-195	Thermal Desorber Conditioning Oven	226	Elite-23	194			Elite-2560.....	194			Elite-502.2.....	193			Elite-608.....	193			Elite-Alumina PLOT	195			Elite-Alumina/KCl PLOT	195			Elite-BAC	190			Elite-Betecyclodextrin	193			Elite-CLPesticides	192			Elite-Cyclosis B PLOT.....	195			Elite-FFAP.....	194			Elite-Molesive PLOT.....	195			Elite-MTBE	194			Elite-PONA.....	194			Elite-Q PLOT	195			Elite-RX.....	193			Elite-SimDist	193			Elite-SimDist HT	194			Elite-TPH.....	194			Elite-VMS.....	191			Elite-Volatiles	192			Elite-XLB	191			Custom Packed Columns.....	197		
Elite-17	180	Ferrules and Connectors.....	200																																																																																																																																																																																												
Elite-1701	186	Fittings.....	201																																																																																																																																																																																												
Elite-17MS	181	Gas Management.....	229-243																																																																																																																																																																																												
Elite-17MS+.....	181	Compressors	240																																																																																																																																																																																												
Elite-1HT.....	177	Filters	229-233																																																																																																																																																																																												
Elite-1MS.....	177	Flow Meter.....	243																																																																																																																																																																																												
Elite-200.....	183	Generators - Hydrogen.....	234-237																																																																																																																																																																																												
Elite-225.....	184	Generators - Zero Air.....	238-239																																																																																																																																																																																												
Elite-35.....	182	Leak Detector.....	242																																																																																																																																																																																												
Elite-35MS.....	182	Regulators.....	241																																																																																																																																																																																												
Elite-5.....	178	Injection Port Septum.....	213																																																																																																																																																																																												
Elite-5 Amine.....	178	Injectors	204-209																																																																																																																																																																																												
Elite-5HT.....	178	Liners.....	210-211																																																																																																																																																																																												
Elite-5MS.....	179	Marathon Filament	221																																																																																																																																																																																												
Elite-5MS II	179	Organic Standards	244-245																																																																																																																																																																																												
Elite-624.....	189	SMARTSource	222-223																																																																																																																																																																																												
Elite-624 MS.....	189	Syringes	212																																																																																																																																																																																												
Elite-WAX.....	187	Swafer.....	202-203																																																																																																																																																																																												
Elite-WAX ETR	188	Thermal Desorber Consumables and Accessories....	224-227																																																																																																																																																																																												
Velocity-1	196	Conditioning Oven.....	226																																																																																																																																																																																												
Velocity-5	196	Kits and Accessories	225																																																																																																																																																																																												
Velocity-WAX.....	196	Packed Traps	224																																																																																																																																																																																												
Capillary Columns - Integrated Guard Columns	173	Tubes	227																																																																																																																																																																																												
Capillary Columns - Specialty Phases	190-195	Thermal Desorber Conditioning Oven	226																																																																																																																																																																																												
Elite-23	194																																																																																																																																																																																														
Elite-2560.....	194																																																																																																																																																																																														
Elite-502.2.....	193																																																																																																																																																																																														
Elite-608.....	193																																																																																																																																																																																														
Elite-Alumina PLOT	195																																																																																																																																																																																														
Elite-Alumina/KCl PLOT	195																																																																																																																																																																																														
Elite-BAC	190																																																																																																																																																																																														
Elite-Betecyclodextrin	193																																																																																																																																																																																														
Elite-CLPesticides	192																																																																																																																																																																																														
Elite-Cyclosis B PLOT.....	195																																																																																																																																																																																														
Elite-FFAP.....	194																																																																																																																																																																																														
Elite-Molesive PLOT.....	195																																																																																																																																																																																														
Elite-MTBE	194																																																																																																																																																																																														
Elite-PONA.....	194																																																																																																																																																																																														
Elite-Q PLOT	195																																																																																																																																																																																														
Elite-RX.....	193																																																																																																																																																																																														
Elite-SimDist	193																																																																																																																																																																																														
Elite-SimDist HT	194																																																																																																																																																																																														
Elite-TPH.....	194																																																																																																																																																																																														
Elite-VMS.....	191																																																																																																																																																																																														
Elite-Volatiles	192																																																																																																																																																																																														
Elite-XLB	191																																																																																																																																																																																														
Custom Packed Columns.....	197																																																																																																																																																																																														

Cones	57
Cone Removal Tool.....	57
Hyper Skimmer Cone and Spares.....	57
Sampler and Skimmer Cone O-Rings	57
Injectors and Adapters	54-55
Injector Support Adapter O-Rings.....	54-55
Injector Support Adapters.....	54-55
Injectors	
Alumina Injectors.....	54
Quartz Injectors	54
Sapphire Injectors	54
PFA Injector Assemblies	54
Mass Spectrometer Hardware	56
Detectors	56
Ion Optics.....	56
Ion Lens.....	56
ShadowStop.....	56
Vacuum Pump Fluid.....	56
Nebulizers and Supplies	48-50
Adapters and Fittings	48-49
End Cap for Concentric Nebulizers	48
Liquid Connector.....	48
Nebulizers	48-50
GemClean Cross-Flow II Nebulizer	48
Meinhard Nebulizers and Spares	48
MicroMist Nebulizers	49
Obstruction Removal Tool	49-50
PFA Nebulizers	38
SeaSpray Nebulizers.....	50
Sample Introduction Kits	58-59
Sample Capillaries	50
Connectors and Spares.....	48
Sample Introduction Kits and Spares Kits.....	58-59
ELAN Spares Kits	58
NexION Consumables Kits	59
Sample Introduction Systems for ELAN	58
Spray Chambers	51-53
Baffled Cyclonic Spray Chambers	51
Cyclonic Spray Chambers	51-52
Scott Spray Chambers	52
Temperature Controlled Spray Chambers.....	53
IsoMist Programmable Temperature Spray Chambers	53
PC ³ Peltier Coolers	53
Torches and Load Coil.....	55
Cassette Torch Mount	55
Demountable Quartz Torches	55
Power Amplifier Tube (Ceramic).....	55
RF Load Coil Assemblies	55
Torch Alignment Tool.....	55

Air Compressors and Replacement Parts	46
Compressors	46
Replacement Parts	46
Benches and Carts	47
Injectors and Adapters	44
Alumina Injectors	44
FAST Injectors	44
Injector Support Adapter O-Ring Kits	44
Injector Support Adapters	44
Quartz Injectors	44
Sapphire Injectors	44
Load Coils and Purge Windows	45
Ceramic Interface Cone	45
Ceramic Purge Extension	45
Purge Component Replacement Parts	45
Purge Extension Windows	45
RF Load Coil	45
Nebulizers and Supplies	34-37
Argon Humidifier	37
Nebulizers	34-37
End Cap for Concentric Nebulizers	34
GemCone High Dissolved Solids Nebulizer	37
GemCone Low-Flow Nebulizers	37
GemTip Cross-Flow II Nebulizers	37
Meinhard Nebulizers	34
MicroMist Nebulizers	34
Mira Mist Nebulizer	34
PFA Nebulizers	36
Sample Capillaries	36
Sample Tube Connectors	36
Seaspray Nebulizers	35
Obstruction Removal Tool	36
Sample Introduction Kits	41
Spray Chambers and Accessories	38-39
Accessories and Drain Parts	38
Baffled Cyclonic Spray Chambers	39
Connectors and Spares	38
Cyclonic Spray Chambers	38
HF Resistant Spray Chambers	39
Scott Spray Chambers	39
Torches, Modules and Hardware	40, 42-43
Torches and Torch Accessories	42-43
Ceramic D-Torch	43
Copper Ignitor Tape	42
Quartz Torches	42-43
Torch Bonnets	42
Torch O-Rings	42
Quick-Change Torch Modules	40
Quick-Change Torch Module Support Stand	40

Accessories Overview	248-249	Imaging Accessories.....	264
Application Packs.....	266	ATR Imaging Upgrade for Spotlight Systems	264
Benzene in Gasoline ASTM D4053-04	266	Crystal Compression Cell	264
Biodiesel.....	266	Diamond Compression Cell	264
Educational	266	Hot Stage Accessory.....	264
Environmental Hydrocarbons ASTM D7066-04	266	Infrared Windows.....	264
Environmental Hydrocarbons ATR.....	266	Micro ATR Objective Upgrade Kit.....	264
Environmental Hydrocarbons Cyclohexane.....	266	Microsampling Tools.....	264
In-Service Lubricants.....	266	Microscope Supplies.....	264
Neutraceutical Compliance.....	266	OilExpress Supplies.....	262
Pharmacopeia Compliance	266	OilExpress Supplies	262
Polymer.....	266	Spare Parts	262
ATR Accessories.....	250-251	Tubes and Bottles	262
PerkinElmer ATR Accessories.....	250	Tubing.....	262
HATR	250	Presses and Accessories.....	261
UATR	250	Evacuatable KBr Mini-press.....	261
Pike ATR Accessories	250-251	Hydraulic KBr Presses.....	261
ATR Miracle	250	KBr Pellet Quick Press	261
GladiATR Vision	251	KBr Powder.....	261
Variable Angle ATR (VATR)	251	Support Rings for KBr Pellets	261
Multiple (10) Reflection HATR	250	Sampling and Starter Kits	265
Specac ATR Accessories.....	250-251	Spectrum Two Portability Options.....	262
25 Reflection ATR	251	Specular Reflectance Accessories.....	255
Gateway HATR	251	PerkinElmer Accessories.....	255
Golden Gate ATR.....	251	Pike Accessories	255
ATR Top Plate Accessories	252-253	Pike Specular Reflectance Options	255
PerkinElmer ATR Top Plates & Options	252	Transmission Accessories and Options.....	256-260
Pike ATR Top Plates & Options	253	Accessories	
Silver Gate Evolution ATR	253	Circular Demountable Cell Windows (Pair)	257
Specac ATR Top Plates & Options.....	253	Circular Spacers.....	257
Desiccant and Laser Kits, Sources and		Crystal Polishing Kit and Replacement Parts	256
Reference Materials	263	DC-2 Diamond Compression Cell.....	259
Disposable Desiccant Kit.....	263	Demountable Cells and Windows	257
Instrument Performance Validation (IPV) Kits	263	FT-NIR Liquid Cells and Holders	258
Rechargeable Desiccant Kits	263	Press-N-Lock Demountable Cell and Windows	258
Replacement Laser Head Kit and Sources.....	263	Press-N-Lock Demountable Cell Windows (Pair)	258
Diffuse Reflectance Accessories and Options	254-255	Rectangular Sealed Liquid Cells.....	258
PerkinElmer Accessories.....	254	Rectangular Semi-Demountable Cell Windows.....	257
Pike Accessories	254	Rectangular Spacers.....	257
Specac Accessories.....	254	Sealed Liquid Cells.....	258
Diffuse Reflectance Options.....	254	Semi-Demountable Cells and Windows	257
PerkinElmer	254	Short Path Demountable Gas Cells.....	259
Pike	254	The Cyclone Series of Fixed and Variable Long	
FT-NIR Consumables and Accessories	267	Pathlength Gas Cells	259
General Consumables	267	The Gasera Photoacoustic PA301 FTIR Accessory.....	260
Reflectance Standards	267	The Oxford Instrument Optistat DN.....	260
Sample Cups.....	267	The Storm Short Pathlength (10 cm) Gas Cell.....	260
Spare Parts.....	267	The Tornado Series of Fixed, Long Pathlength Gas Cells	259
		Variable Temperature Cell	259
		Transmission Options.....	260

Columns	124-153
Cartridge Columns	144-153
Brownlee Aquapore	145
Brownlee CHOICE	150
Brownlee Pecoshpere	147
Brownlee Polypore	149
Brownlee Prep-10 Semi-Preparative	149
Brownlee Spheri-10.....	146
Brownlee Spheri-5.....	146
Brownlee Validated	148
Brownlee VeloSep	151
Column Holders	153
NewGuard	152
Conventional Columns	127-143
Brownlee Analytical	129-131
Brownlee Analytical DB	132-134
Brownlee Aquapore	135
Brownlee Bio	135
Brownlee CHOICE	136-137
Brownlee Validated	138-141
Guard Columns.....	142-143
SPP Columns	124-126
Detector Lamps	155
Fingertight Fittings	162
Flexar Autosampler and Accessories	164-165
Flexar SQ 300 MS Consumables and Accessories	122 -123
Flow Cells	154
General Supplies and Accessories	166-168
Generators - Nitrogen	169-171
Injection Valves	163
Pumps	158-160
Pump Accessory Kits	154
Rotor Seals	163
Sample Loops	161
Tubing	161
Vacuum Degassing Kits	156-157

DMA Supplies..... 296-297

Calibration Supplies.....	296
Replaceable Parts	296
Cooling Accessories.....	297
Specialty Fixtures and Accessories.....	297

DSC Supplies..... 290-292

Calibration Reference Materials	292
Crimpers and Presses.....	290-291
Loading Tools	292
Sample Holder Supplies.....	292
Sample Pan Manipulators.....	292
Sample Pans and Covers.....	290

Elemental Analysis Supplies..... 298-299

Calibration Standards	298
Packing Supplies.....	298
Reagents	298
Receptacles	298
Sample Capsules and Sealers.....	299
Tubes	299
Tubes - Prepacked	298
Tubes and Reagent Kits	298

TGA/STA Supplies 294-295

Autosampler Ceramic Crucible Kits and Liners.....	295
Calibration Reference Materials	295
Cooling Jacket.....	295
Forceps	295
Furnace and Balance Supplies.....	294
Pans.....	295
Replacement Needle Kit	295
Volatile Capsule Sealer Kit	295

TMA Supplies 293

Analysis Kits	293
Probes and Sample Tools	293
Reference Materials.....	293
Spares	293

Cells.....	270-274	Integrating Spheres	280
Cylindrical and Flow-Through Cells.....	273	150 mm Integrating Spheres	280
Disposable Cells	274	50 mm Integrating Sphere	280
Macro Cells.....	270	Cell Holder.....	280
Micro Cells.....	271	Center Mounted Sample Holder.....	280
Semi-Micro Cells	271	Lamps.....	268
Ultra-Micro Cells	272	Deuterium.....	268
Cell Changers.....	276	Tungsten	268
5+5 Cell Changer.....	276	Polarimetry Cells and Accessories.....	283
8+1 Cell Changer.....	276	Beaker Cells	283
8+8 Cell Changer.....	276	Flow Cells.....	283
13 Cell Changer.....	276	Interference Filter	283
Automatic Linear Transport.....	276	Micro Cells.....	283
Gel Cell, Glass.....	276	Pluggable Coupling.....	283
Reference Kit.....	276	PTFE Stopper.....	283
Cell Holders	275	Quartz Standards	283
Cylindrical Long-Path Cell Holder.....	275	Short Path Cells.....	283
Rectangular Long-Path Cell Holder	275	Source Lamps.....	283
Solid Sample Holder	275	Standard Cells.....	283
Standard Cell Holder	275	Standards.....	283
Test Tube Holder.....	275	Polarizers and Depolarizers.....	281
Variable Angle Sample Holder	275	Reference Materials	268-269
Fiber-Optics Accessories	282	Calibration Reference Materials.....	268
Fiber Optic Dip Probe	282	Diffuse Reflectance Standards.....	269
Light Shield	282	Pharmacopoeia Solutions Reference Material Set.....	269
Pair of Mono-Fibers	282	Photometric and Wavelength Accuracy Reference	
Probe Tip.....	282	Material Set.....	269
Transfer-Optic for Mono-Fibers.....	282	Recertification Program for UV/Vis Calibration	
General Purpose Optical Bench Kits	282	Reference Materials	269
Sample Holder Mount Kit.....	282	Reference Mirror for Reflectance Spectroscopy	269
Variable Angle Transmittance Sample Holder Kit.....	282	Stray Light Solutions Reference Material Set	269
Optical Bench Kit.....	282	Specular Reflectance Accessories.....	279
Short Focal Length Mirror Kit, Spot Incidence	282	Relative Specular Reflectance Accessories	279
Beam Blocker Kit.....	282	Universal Reflectance Accessory (URA).....	279
Fiber Optic Measurement Stage and Holder Kit	282	Variable-Angle Relative Specular Reflectance Accessory	279
Fluorescence Consumables and Accessories	284-289	Sipper.....	281
Cells.....	284-285	Thermostatting Accessories	277-278
Lamps	286	Research Peltier Systems.....	278
Fluorescence Thermostatting Accessories.....	287	Routine Peltier Systems.....	277
Biokinetics Accessory	287		
Four-Position Thermostatted Automatic Cell Changer	287		
Luminescence Accessory	287		
Sample Tubes	287		
Single-Cell Peltier Accessory.....	287		
Single-Position Thermostatted Cell Holder.....	287		
Reference Materials.....	286		
Sampling Accessories	288-289		
Front-Surface Accessory.....	289		
LC Flow Cell Accessory	288		
Liquid Sipper Accessory.....	288		
Remote Fiber-Optic Accessory.....	289		
Total Emission Accessory.....	289		
Well-Plate Reader Accessory	288		

PerkinElmer, Inc.
940 Winter Street
Waltham, MA 02451 USA
P: (800) 762-4000 or
(+1) 203-925-4602
www.perkinelmer.com



For a complete listing of our global offices, visit www.perkinelmer.com/ContactUs

Copyright ©2014, PerkinElmer, Inc. All rights reserved. PerkinElmer is a trademark of PerkinElmer, Inc. All other trademarks are the property of their respective owners.

011640_02